



Motorparts



cataliogo 2017

Motorparts

Edizione: Novembre 2016

Immagini, dati e indicazioni tecniche contenute in questo catalogo non sono impegnative.
Motorparts si riserva di apportare, per aggiornamenti o migliorie, qualsiasi tipo di variazione anche senza preavviso.

Indice generale



APPLICABILITÀ

Moto 50 cc	p. 10
Scooter 50 cc	p. 30
Scooter 50 cc racing	p. 92
Maxi scooter	p. 122
Moto 125 cc	p. 210
Atv	p. 214

TOP PERFORMANCES

Accensioni	p. 304
Alberi a camme	p. 277
Campane frizione	p. 265
Carica batterie	p. 308
Cinghie di trasmissione	p. 229
Contagiri	p. 308
Convertitori di coppia	p. 252
Coperchi	p. 253
Frizioni	p. 259
Gruppi termici	p. 264
Imbiellaggi	p. 280
Imbiellaggi / Cuscinetti	p. 281
Kit aspirazione	p. 268
Kit di programmazione	p. 308
Masse variatore	p. 248
Molle contrasto variatore	p. 254
Molle frizione	p. 266
Pignoni / Ingranaggi / Rapporti	p. 278
Regolatore di pressione	p. 308
Scarichi moto racing	p. 298
Scarichi Nardò 2	p. 299
Scarichi powered omologati	p. 300
Scarichi HP2	p. 302
Scarichi GP	p. 304
Valvole lamellari	p. 274
Variatori	p. 218

Indice generale



SPARE PARTS

Accensioni	p. 337
Alberi	p. 350
AM6 - Ricambi motore	p. 332
Batterie	p. 312
Bielle	p. 374
Blocchi accensione	p. 335
Bobine	p. 336
Campane frizione	p. 370
Carburatori	p. 348
Collettori	p. 354
Convogliatori	p. 353
Cuscinetti	p. 383
Filtri olio	p. 358
Frizioni	p. 364
Gabbia / Molle	p. 331
Imbiellaggi	p. 375
Ingranaggi	p. 352
Intermittenze	p. 339
Kit revisione pompa acqua	p. 324
Membrane carburatore	p. 392
Motorini avviamento	p. 386
Paraoli / Serie paraoli	p. 382
Pompe benzina	p. 331
Pulegge variatori	p. 394
Regolatori	p. 339
Ruote libere	p. 396
Segmenti	p. 405
Statori	p. 339
Valvole lamellari	p. 347

DR RACING PARTS

Cilindretti freno	p. 415
Filtri benzina	p. 416
Frizioni	p. 416
Ganasce freno	p. 414
Gruppi termici	p. 421
Guarnizioni	p. 419
Serie Guarnizioni	p. 417
Segmenti	p. 432
Scarichi	p. 420
Valvole lamellari	p. 432

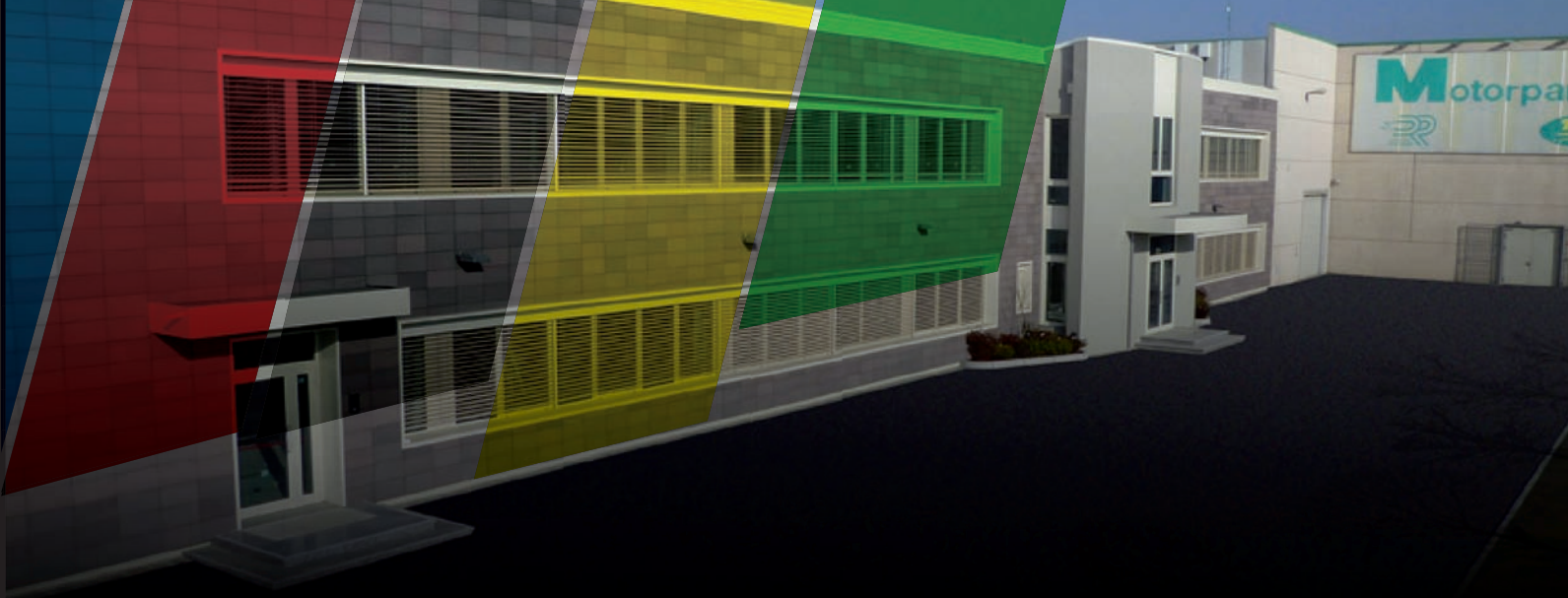

La tradizione di un marchio sempre al Top!

Motorparts è da sempre **garanzia di affidabilità e innovazione** nella progettazione di parti speciali, ricambi e accessori per le due ruote. L'azienda nasce nel 1965 come distributore di ricambi originali per la Motori Minarelli, storico marchio d'eccellenza del motociclismo italiano di cui segue la tradizione di qualità e serietà.

Negli anni '90 amplia il suo raggio d'azione dedicandosi allo sviluppo di parti speciali da competizione attraverso il brand **Top Performances**, con alle spalle il lavoro incessante di un'avanzatissimo reparto **Ricerca e Sviluppo**, vero fiore all'occhiello dell'innovazione Motorparts.

Parallelamente si espande sul mercato della componentistica per ciclomotori acquisendo il marchio **DR Racing Parts**, che porta in dote nella famiglia Motorparts i know how relativi a sviluppo e distribuzione di kit Vespa e parti speciali scooter Piaggio, Honda e Peugeot.

La gamma prodotti Motorparts si rinnova e si evolve costantemente, ecco il perché di questo catalogo 2017 che illustra, con dettagliate schede tecniche e di compatibilità per ciascun modello, pezzi e accessori disponibili nella rete di vendita, ramificata capillarmente in Italia ed in più di 40 paesi nel Mondo.

Motorparts

Elevate prestazioni, massima affidabilità!

La filosofia Motorparts è sempre stata quella di puntare al potenziamento delle performances del mezzo garantendo comunque la massima affidabilità nell'esperienza di guida. Passione per il mondo delle due ruote e volontà di soddisfare il cliente a 360° gradi hanno accompagnato l'azienda attraverso mezzo secolo di esperienza industriale e commerciale, sempre ai massimi livelli.

Il punto di forza è nel controllo dell'intero ciclo produttivo: dalla fase di progettazione nell'avanzatissimo reparto Ricerca e sviluppo, a quella produttiva vera e propria, fino ai test di verifica nel reparto collaudo, dove sofisticati banchi prova stazionari e dinamici permettono di eseguire accurati controlli sul veicolo completo, simulando condizioni d'uso estreme rispetto al normale impiego su strada.

L'assoluta esperienza dello staff tecnico Motorparts nasce dal legame col team che portò la Motori Minarelli ad aggiudicarsi innumerevoli trofei nei mondiali di velocità, nei campionati italiani ed europei di cross, a stabilire record mondiali di velocità ancora imbattuti. Con l'ingresso nel Gruppo del marchio DR Racing Parts - apprezzatissimo dai tecnici del settore - l'azienda acquisisce l'esclusivo know how in materia di componentistica per ciclomotori, sviluppando e distribuendo kit Vespa e parti speciali per scooter Piaggio, Honda e Peugeot.

Da questa indiscussa competenza e dal continuo scanning delle esigenze di un mercato consapevole e competitivo, nasce il nuovo minicatalogo per parti speciali Vespa, disponibile presso i migliori rivenditori.



Motorparts

è distributore ufficiale

odigeTM

RACING PARTS ITALY



Motorparts

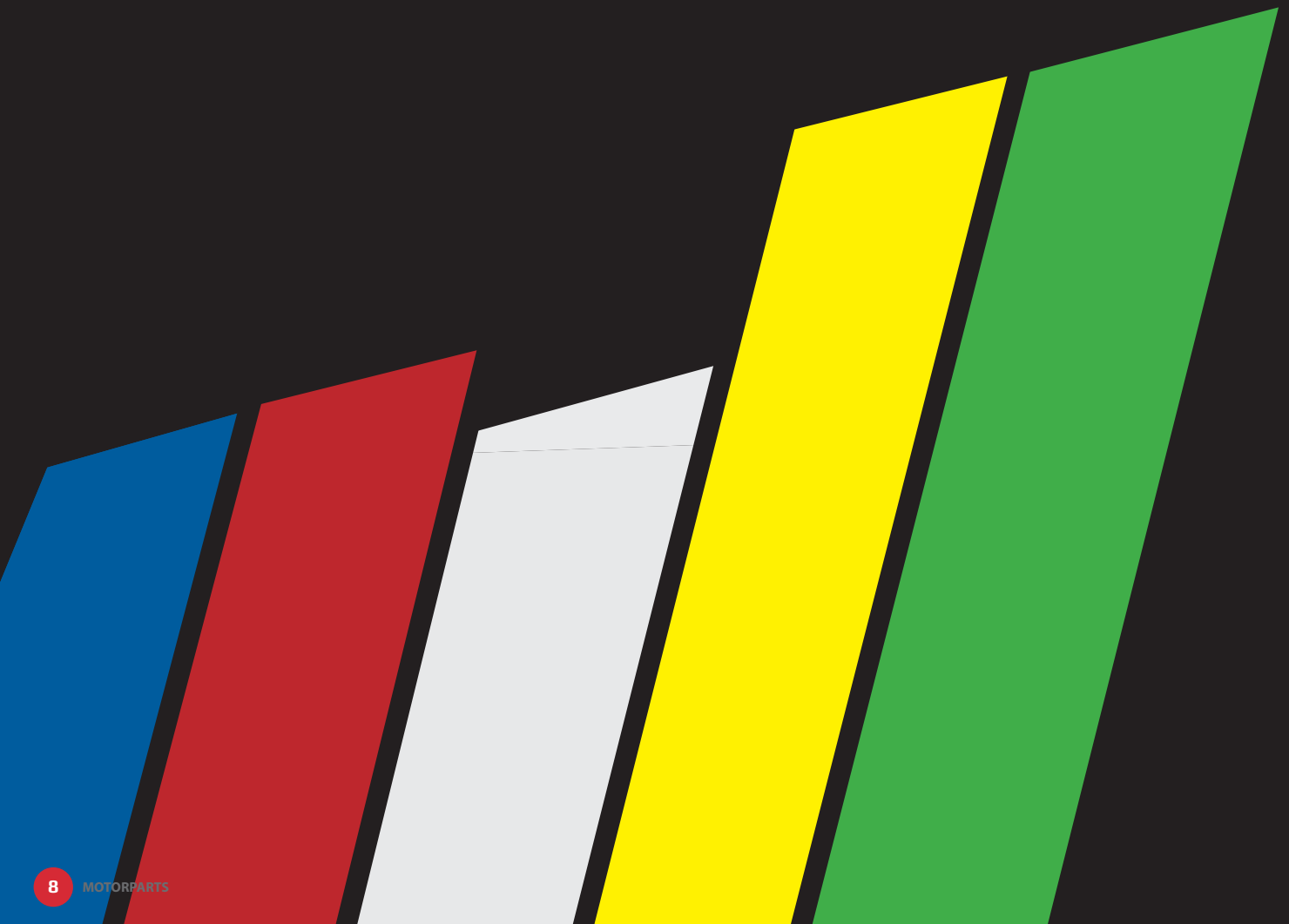

gamma prodotti **2017**



MOTO 50cc



Aprilia	Aprilia	Aprilia	Aprilia	Aprilia	Aprilia
Classic	Europa	Europa	MX 50	MX 50 Motard	Pegaso
92-99	90-90	91-92	04-04	95-03	92-94
50cc 2T LC	50cc 2T LC	50cc 2T LC	50cc 2T LC	50cc 2T LC	50cc 2T LC
AM 6	RV4	AM 3-4-5	AM 6	AM 6	AM 3-4-5

ALBERO MOTORE corsa 39 mm a piattelli pieni			9921720		9921720	9921720	9921720	9921720
BIELLA		Axe 16	IM07033		IM07033	IM07033	IM07033	IM07033
		Axe 18	IM07036		IM07036	IM07036	IM07036	IM07036
CENTRALINA digitale ad anticipo variabile volano Ducati 6 poli			9921690		9921690	9921690	9921690	9921690
CUSCINETTI DI BANCO TPR Carbonitrurati		Serie	9929180		9929180	9929180	9929180	9929180
DESMODROMICO Cambio			9920020		9920020			
FRIZIONE Denti dritti			9918550		9918550	9918550	9918550	9918550
GRUPPO TERMICO Ø standard ghisa			9916770		9916770	9916770	9916770	9916770
GRUPPO TERMICO Ø maggiorato ghisa			9919250		9919250	9919250	9919250	9919250
GRUPPO TERMICO RACING Ø maggiorato ghisa			9919240		9919240	9919240	9919240	9919240
GRUPPO TERMICO RACING Ø maggiorato ghisa c/testa scomposta			9921150		9921150	9921150	9921150	9921150
GRUPPO TERMICO RACING Ø maggiorato alluminio			9924130		9924130	9924130	9924130	9924130
INGRANAGGIO 6ª VELOCITÀ		AM6 1ª Versione	9919080		9919080	9919080		
		AM6 2ª Versione	9931910		9931910	9931910		
KIT ASPIRAZIONE COMPLETO TM24			9930910		9930910	9930910	9930910	9930910
KIT ASPIRAZIONE COMPLETO OKO 28			9931750		9931750	9931750	9931750	9931750
MAXI KIT RACING 85 cc ghisa Ø 49,5 corsa 44			9921450		9921450	9921450	9921450	9921450
MAXI KIT RACING 85 cc alluminio Ø 50 corsa 44			9924240		9924240	9924240	9924240	9924240
MOTORINO D'AVVIAMENTO			MA00018		MA00018			MA00018
SCARICO RACING								
SCARICO RACING Omologato								
SERIE DISCHI Frizione racing cellulosa/kevlar			9921180		9921180	9921180	9921180	9921180
SERIE DISCHI Standard			9920250		9920250	9920250	9920250	9920250
TRASDUTTORE Per volano Ducati 6 poli			9910150		9910150	9910150	9910150	9910150
VALVOLA LAMELLARE			9906500	9906500	9906500	9906500	9906500	9906500
VALVOLA TPR			9931600	9931600	9931600	9931600	9931600	9931600

Aprilia	Aprilia	Aprilia	Aprilia	Aprilia	Aprilia	Aprilia	Aprilia	Aprilia	Aprilia	Aprilia
RS 50	RS 50	RS 50	RS 50	RS 50	RS4	RX 50	RX 50	RX 50	RX 50	RX 50 3-5 Marce
91-92	93-95	96-98	99-05	06-10	11-13	89-90	03-04	06-10	-	91-94
50cc 2T LC	50cc 2T LC	50cc 2T LC	50cc 2T LC	50cc 2T LC	50cc 2T LC	50cc 2T LC	50cc 2T LC	50cc 2T LC	50cc 2T LC	50cc 2T LC
AM 3-4-5	AM 3-4-5-6	AM 6	AM 6	D50B1	D50B1	RV4	AM 6	D50B1	D50B1	AM 3-4-5
9921720	9921720	9921720	9921720				9921720			9921720
IM07033	IM07033	IM07033	IM07033				IM07033			IM07033
IM07036	IM07036	IM07036	IM07036				IM07036			IM07036
9921690	9921690	9921690	9921690				9921690			9921690
9929180	9929180	9929180	9929180	9929190	9929190		9929180	9929190	9929190	9929180
	9920020	9920020	9920020				9920020			
9918550	9918550	9918550	9918550				9918550			9918550
9916770	9916770	9916770	9916770	9927100	9927100		9916770	9927100	9927100	9916770
9919250	9919250	9919250	9919250	9927020	9927020		9919250	9927020	9927020	9919250
9919240	9919240	9919240	9919240				9919240			9919240
9921150	9921150	9921150	9921150				9921150			9921150
9924130	9924130	9924130	9924130				9924130			9924130
	9919080	9919080	9919080				9919080			
	9931910	9931910	9931910				9931910			
9930910	9930910	9930910	9930910	9930910	9930910		9930910	9930910	9930910	9930910
9931750	9931750	9931750	9931750	9931750	9931750		9931750	9931750	9931750	9931750
9921450	9921450	9921450	9921450				9921450			9921450
9924240	9924240	9924240	9924240				9924240			9924240
MA00018	MA00018	MA00018	MA00018	MA00015	MA00015					
			9926370							
9921180	9921180	9921180	9921180	9923190	9923190		9921180	9923190	9923190	9921180
9920250	9920250	9920250	9920250				9920250			9920250
9910150	9910150	9910150	9910150				9910150			9910150
9906500	9906500	9906500	9906500			9906500	9906500			9906500
9931600	9931600	9931600	9931600			9931600	9931600			9931600

MOTO 50cc



Aprilia	Aprilia	Aprilia	Aprilia	Aprilia	Beta
RX 50 Enduro	RX 50 Racing	SX	SX 50	Tuono 50	RR Alu
95-03	03-06	06-10	-	03-04	00-
50cc 2T LC	50cc 2T LC	50cc 2T LC	50cc 2T LC	50cc 2T LC	50cc 2T LC
AM 6	AM 6	D50B1	D50B1	AM 6	AM 6

ALBERO MOTORE corsa 39 mm a piattelli pieni			9921720	9921720			9921720	9921720
BIELLA		Axe 16	IM07033	IM07033			IM07033	IM07033
		Axe 18	IM07036	IM07036			IM07036	IM07036
CENTRALINA digitale ad anticipo variabile volano Ducati 6 poli			9921690	9921690			9921690	9921690
CUSCINETTI DI BANCO TPR Carbonitrurati		Serie	9929180	9929180	9929190	9929190	9929180	9929180
DESMODROMICO Cambio							9920020	9920020
FRIZIONE Denti dritti			9918550	9918550			9918550	9918550
GRUPPO TERMICO Ø standard ghisa			9916770	9916770	9927100	9927100	9916770	9916770
GRUPPO TERMICO Ø maggiorato ghisa			9919250	9919250	9927020	9927020	9919250	9919250
GRUPPO TERMICO RACING Ø maggiorato ghisa			9919240	9919240			9919240	9919240
GRUPPO TERMICO RACING Ø maggiorato ghisa c/testa scomposta			9921150	9921150			9921150	9921150
GRUPPO TERMICO RACING Ø maggiorato alluminio			9924130	9924130			9924130	9924130
INGRANAGGIO 6ª VELOCITÀ		AM6 1ª Versione	9919080				9919080	9919080
		AM6 2ª Versione	9931910				9931910	9931910
KIT ASPIRAZIONE COMPLETO TM24			9930910	9930910	9930910	9930910	9930910	9930910
KIT ASPIRAZIONE COMPLETO OKO 28			9931750	9931750	9931750	9931750	9931750	9931750
MAXI KIT RACING 85 cc ghisa Ø 49,5 corsa 44			9921450	9921450			9921450	9921450
MAXI KIT RACING 85 cc alluminio Ø 50 corsa 44			9924240	9924240			9924240	9924240
MOTORINO D'AVVIAMENTO							MA00018	
SCARICO RACING							9926370	
SCARICO RACING Omologato								
SERIE DISCHI Frizione racing cellulosa/kevlar			9921180	9921180	9923190	9923190	9921180	9921180
SERIE DISCHI Standard			9920250	9920250			9920250	9920250
TRASDUTTORE Per volano Ducati 6 poli			9910150	9910150			9910150	9910150
VALVOLA LAMELLARE			9906500	9906500			9906500	9906500
VALVOLA TPR			9931600	9931600			9931600	9931600

Beta	Beta	CH Husquarna	CH Husquarna	CH Husquarna	CMC	CMC	Derbi	Derbi	Derbi	Derbi
RR Enduro 50	RR Motard 50	SM 50	WR 50	WSM 50	Enduro 50	Motard 50	Bultaco Lobito	GPR 2T EU2	GPR NUDE	GPR NUDE & GPR NUDE Tuning
00-	00-	-00	-00	-00	11-11	11-11	98-01	09-10	04-05	06-08
50cc 2T LC	50cc 2T LC	50cc 2T LC	50cc 2T LC	50cc 2T LC	50cc 2T LC	50cc 2T LC	50cc 2T LC	50cc 2T LC	50cc 2T LC	50cc 2T LC
AM 6	AM 6	AM 6	AM 6	AM 6	AM 6	AM 6		D50B0	EBE050	D50B0
9921720	9921720	9921720	9921720	9921720	9921720	9921720				
IM07033	IM07033	IM07033	IM07033	IM07033	IM07033	IM07033				
IM07036	IM07036	IM07036	IM07036	IM07036	IM07036	IM07036				
9921690	9921690	9921690	9921690	9921690						
9929180	9929180	9929180	9929180	9929180	9929180	9929180	9929190	9929190	9929190	9929190
9920020	9920020	9920020	9920020	9920020	9920020	9920020				
9918550	9918550	9918550	9918550	9918550	9918550	9918550				
9916770	9916770	9916770	9916770	9916770	9916770	9916770	9917400	9927100	9917400	9927100
9919250	9919250	9919250	9919250	9919250	9919250	9919250	9917390	9927020	9917390	9927020
9919240	9919240	9919240	9919240	9919240	9919240	9919240				
9921150	9921150	9921150	9921150	9921150	9921150	9921150				
9924130	9924130	9924130	9924130	9924130	9924130	9924130				
9919080	9919080	9919080	9919080	9919080	9919080	9919080				
9931910	9931910	9931910	9931910	9931910	9931910	9931910				
9930910	9930910	9930910	9930910	9930910	9930910	9930910	9930910	9930910	9930910	9930910
9931750	9931750	9931750	9931750	9931750	9931750	9931750	9931750	9931750	9931750	9931750
9921450	9921450	9921450	9921450	9921450	9921450	9921450				
9924240	9924240	9924240	9924240	9924240	9924240	9924240				
								MA00015		MA00015
9921180	9921180	9921180	9921180	9921180	9921180	9921180	9923190	9923190	9923190	9923190
9920250	9920250	9920250	9920250	9920250	9920250	9920250				
9910150	9910150	9910150	9910150	9910150						
9906500	9906500	9906500	9906500	9906500	9906500	9906500				
9931600	9931600	9931600	9931600	9931600	9931600	9931600				

MOTO 50cc



Derbi	Derbi	Derbi	Derbi	Derbi	Derbi
GPR NUDE Sport	GPR R	GPR R EU2 - GPR Replica EU2	GPR Racing	GPR Racing EU2	GPR Replica
06-06	97-00	08-08	04-05	06-06	99-01
50cc 2T LC	50cc 2T LC	50cc 2T LC	50cc 2T LC	50cc 2T LC	50cc 2T LC
D50B0	EBE050	D50B0	EBE050	D50B0	EBE050

ALBERO MOTORE corsa 39 mm a piattelli pieni								
BIELLA		Axe 16						
		Axe 18						
CENTRALINA digitale ad anticipo variabile volano Ducati 6 poli								
CUSCINETTI DI BANCO TPR Carbonitrurati		Serie	9929190	9929190	9929190	9929190	9929190	9929190
DESMODROMICO Cambio								
FRIZIONE Denti dritti								
GRUPPO TERMICO Ø standard ghisa			9927100	9917400	9927100	9917400	9927100	9917400
GRUPPO TERMICO Ø maggiorato ghisa			9927020	9917390	9927020	9917390	9927020	9917390
GRUPPO TERMICO RACING Ø maggiorato ghisa								
GRUPPO TERMICO RACING Ø maggiorato ghisa c/testa scomposta								
GRUPPO TERMICO RACING Ø maggiorato alluminio								
INGRANAGGIO 6ª VELOCITÀ		AM6 1ª Versione						
		AM6 2ª Versione						
KIT ASPIRAZIONE COMPLETO TM24			9930910	9930910	9930910	9930910	9930910	9930910
KIT ASPIRAZIONE COMPLETO OKO 28			9931750	9931750	9931750	9931750	9931750	9931750
MAXI KIT RACING 85 cc ghisa Ø 49,5 corsa 44								
MAXI KIT RACING 85 cc alluminio Ø 50 corsa 44								
MOTORINO D'AVVIAMENTO			MA00015		MA00015		MA00015	
SCARICO RACING								
SCARICO RACING Omologato								
SERIE DISCHI Frizione racing cellulosa/kevlar			9923190	9923190	9923190	9923190	9923190	9923190
SERIE DISCHI Standard								
TRASDUTTORE Per volano Ducati 6 poli								
VALVOLA LAMELLARE								
VALVOLA TPR								

Derbi	Derbi	Derbi	Derbi	Derbi	Derbi	Derbi	Derbi	Derbi	Derbi	Derbi
GPR Replica & GPR R EU2	GPR Replica 2T Malossi	GPR Replica Pesek EU2	GPR Replica Racing	GPR Replica Racing	GPR Replica Racing EU2	Sebda R Racer	Senda Black Edition	Senda HYP DRD Evo EU2	Senda HYP DRD Evo Limited Edition EU2	Senda R
06-06	07-07	07-07	02-02	03-03	05-05	03-03	03-03	08-09	08-08	99-99
50cc 2T LC	50cc 2T LC	50cc 2T LC	50cc 2T LC	50cc 2T LC	50cc 2T LC	50cc 2T LC	50cc 2T LC	50cc 2T LC	50cc 2T LC	50cc 2T LC
D50B0	D50B0	D50B0	EBE050	EBE050	EBE050	EBS050	EBS050	D50B0	D50B0	EBS050
9929190	9929190	9929190	9929190	9929190	9929190	9929190	9929190	9929190	9929190	9929190
9927100	9927100	9927100	9917400	9917400	9917400	9917400	9917400	9927100	9927100	9917400
9927020	9927020	9927020	9917390	9917390	9917390	9917390	9917390	9927020	9927020	9917390
9930910	9930910	9930910	9930910	9930910	9930910	9930910	9930910	9930910	9930910	9930910
9931750	9931750	9931750	9931750	9931750	9931750	9931750	9931750	9931750	9931750	9931750
MA00015	MA00015	MA00015								
9923190	9923190	9923190	9923190	9923190	9923190	9923190	9923190	9923190	9923190	9923190

MOTO 50cc



Derbi	Derbi	Derbi	Derbi	Derbi	Derbi
Senda R	Senda R DRD EU1 EU1R	Senda R DRD PRO EU2	Senda R DRD Racing	Senda R DRD Racing EU2	Senda R DRD Racing LTD
00-01	02-02	05-11	04-05	05-08	05-05
50cc 2T LC	50cc 2T LC	50cc 2T LC	50cc 2T LC	50cc 2T LC	50cc 2T LC
EBS050	EBS050	D50B0	EBS050	D50B0	EBS050

ALBERO MOTORE corsa 39 mm a piattelli pieni							
BIELLA		Axe 16					
		Axe 18					
CENTRALINA digitale ad anticipo variabile volano Ducati 6 poli							
CUSCINETTI DI BANCO TPR Carbonitrurati		Serie	9929190	9929190	9929190	9929190	9929190
DESMODROMICO Cambio							
FRIZIONE Denti dritti							
GRUPPO TERMICO Ø standard ghisa			9917400	9917400	9927100	9917400	9927100
GRUPPO TERMICO Ø maggiorato ghisa			9917390	9917390	9927020	9917390	9927020
GRUPPO TERMICO RACING Ø maggiorato ghisa							
GRUPPO TERMICO RACING Ø maggiorato ghisa c/testa scomposta							
GRUPPO TERMICO RACING Ø maggiorato alluminio							
INGRANAGGIO 6ª VELOCITÀ		AM6 1ª Versione					
		AM6 2ª Versione					
KIT ASPIRAZIONE COMPLETO TM24			9930910	9930910	9930910	9930910	9930910
KIT ASPIRAZIONE COMPLETO OKO 28			9931750	9931750	9931750	9931750	9931750
MAXI KIT RACING 85 cc ghisa Ø 49,5 corsa 44							
MAXI KIT RACING 85 cc alluminio Ø 50 corsa 44							
MOTORINO D'AVVIAMENTO				MA00015			
SCARICO RACING							
SCARICO RACING Omologato							
SERIE DISCHI Frizione racing cellulosa/kevlar			9923190	9923190	9923190	9923190	9923190
SERIE DISCHI Standard							
TRASDUTTORE Per volano Ducati 6 poli							
VALVOLA LAMELLARE							
VALVOLA TPR							

Derbi	Derbi	Derbi	Derbi	Derbi	Derbi	Derbi	Derbi	Derbi	Derbi	Derbi
Senda R X-RACE	Senda R X-RACE	Senda R X-RACE 2T EU2	Senda R X-RACE EU2	Senda R X-RACE EU2	Senda R X-TREME	Senda R X-TREME	Senda R X-TREME 2T EU2	Senda R X-TREME EU2	Senda R X-TREME EU2	Senda R X-TREME EU2
04-04	05-05	10-10	06-06	07-09	03-03	05-05	-	04-04	05-06	07-07
50cc 2T LC	50cc 2T LC	50cc 2T LC	50cc 2T LC	50cc 2T LC	50cc 2T LC	50cc 2T LC	50cc 2T LC	50cc 2T LC	50cc 2T LC	50cc 2T LC
EBS050	EBS050	D50B0	D50B0	D50B0	EBS050	EBS050	D50B0	EBS050	D50B0	D50B0
9929190	9929190	9929190	9929190	9929190	9929190	9929190	9929190	9929190	9929190	9929190
9917400	9917400	9927100	9927100	9927100	9917400	9917400	9927100	9917400	9927100	9927100
9917390	9917390	9927020	9927020	9927020	9917390	9917390	9927020	9917390	9927020	9927020
9930910	9930910	9930910	9930910	9930910	9930910	9930910	9930910	9930910	9930910	9930910
9931750	9931750	9931750	9931750	9931750	9931750	9931750	9931750	9931750	9931750	9931750
9923190	9923190	9923190	9923190	9923190	9923190	9923190	9923190	9923190	9923190	9923190

MOTO 50cc



Derbi	Derbi	Derbi	Derbi	Derbi	Derbi
Senda R X-TREME EU2	Senda SM	Senda SM DRD EU1 EU1R	Senda SM DRD Edition Black	Senda SM DRD PRO EU2	Senda SM DRD Racing
08-08	00-01	02-03	05-05	05-11	04-05
50cc 2T LC	50cc 2T LC	50cc 2T LC	50cc 2T LC	50cc 2T LC	50cc 2T LC
D50B0	EBS050	EBS050	EBS050	D50B0	EBS050

ALBERO MOTORE corsa 39 mm a piattelli pieni							
BIELLA		Axe 16					
		Axe 18					
CENTRALINA digitale ad anticipo variabile volano Ducati 6 poli							
CUSCINETTI DI BANCO TPR Carbonitrurati		Serie	9929190	9929190	9929190	9929190	9929190
DESMODROMICO Cambio							
FRIZIONE Denti dritti							
GRUPPO TERMICO Ø standard ghisa			9927100	9917400	9917400	9917400	9917400
GRUPPO TERMICO Ø maggiorato ghisa			9927020	9917390	9917390	9917390	9917390
GRUPPO TERMICO RACING Ø maggiorato ghisa							
GRUPPO TERMICO RACING Ø maggiorato ghisa c/testa scomposta							
GRUPPO TERMICO RACING Ø maggiorato alluminio							
INGRANAGGIO 6ª VELOCITÀ		AM6 1ª Versione					
		AM6 2ª Versione					
KIT ASPIRAZIONE COMPLETO TM24			9930910	9930910	9930910	9930910	9930910
KIT ASPIRAZIONE COMPLETO OKO 28			9931750	9931750	9931750	9931750	9931750
MAXI KIT RACING 85 cc ghisa Ø 49,5 corsa 44							
MAXI KIT RACING 85 cc alluminio Ø 50 corsa 44							
MOTORINO D'AVVIAMENTO						MA00015	
SCARICO RACING							
SCARICO RACING Omologato							
SERIE DISCHI Frizione racing cellulosa/kevlar			9923190	9923190	9923190	9923190	9923190
SERIE DISCHI Standard							
TRASDUTTORE Per volano Ducati 6 poli							
VALVOLA LAMELLARE							
VALVOLA TPR							

Derbi	Derbi	Derbi	Derbi	Derbi	Derbi	Derbi	Derbi	Derbi	Derbi	Derbi
Senda SM DRD Racing EU2	Senda SM DRD Racing LTD	Senda SM DRD Racing LTD EU2	Senda SM X-RACE	Senda SM X-RACE	Senda SM X-RACE 2T EU2	Senda SM X-RACE EU2	Senda SM X-RACE EU2	Senda SM X-TREME	Senda SM X-TREME	Senda SM X-TREME 2T EU2
05-08	05-05	07-07	04-04	05-05	10-10	06-06	07-09	02-02	03-03	10-10
50cc 2T LC	50cc 2T LC	50cc 2T LC	50cc 2T LC	50cc 2T LC	50cc 2T LC	50cc 2T LC	50cc 2T LC	50cc 2T LC	50cc 2T LC	50cc 2T LC
D50B0	EBS050	D50B0	EBS050	EBS050	D50B0	D50B0	D50B0	EBS050	EBS050	D50B0
9929190	9929190	9929190	9929190	9929190	9929190	9929190	9929190	9929190	9929190	9929190
9927100	9917400	9927100	9917400	9917400	9927100	9927100	9927100	9917400	9917400	9927100
9927020	9917390	9927020	9917390	9917390	9927020	9927020	9927020	9917390	9917390	9927020
9930910	9930910	9930910	9930910	9930910	9930910	9930910	9930910	9930910	9930910	9930910
9931750	9931750	9931750	9931750	9931750	9931750	9931750	9931750	9931750	9931750	9931750
9923190	9923190	9923190	9923190	9923190	9923190	9923190	9923190	9923190	9923190	9923190

MOTO 50cc



Derbi	Derbi	Derbi	Derbi	Fantic	Fantic
Senda SM XTREME EU2	Senda SM XTREME EU2	Senda SM XTREME EU2	Senda SM XTREME EU2	Caballero Motard	Caballero Motard
04-04	05-06	07-07	08-08	06-09	10-10
50cc 2T LC	50cc 2T LC	50cc 2T LC	50cc 2T LC	50cc 2T LC	50cc 2T LC
EBS050	D50B0	D50B0	D50B0	AM 6	AM 6

ALBERO MOTORE corsa 39 mm a piattelli pieni						9921720	9921720
BIELLA		Axe 16				IM07033	IM07033
		Axe 18				IM07036	IM07036
CENTRALINA digitale ad anticipo variabile volano Ducati 6 poli						9921690	9921690
CUSCINETTI DI BANCO TPR Carbonitrurati		Serie	9929190	9929190	9929190	9929180	9929180
DESMODROMICO Cambio						9920020	9920020
FRIZIONE Denti dritti						9918550	9918550
GRUPPO TERMICO Ø standard ghisa			9917400	9927100	9927100	9916770	9916770
GRUPPO TERMICO Ø maggiorato ghisa			9917390	9927020	9927020	9919250	9919250
GRUPPO TERMICO RACING Ø maggiorato ghisa						9919240	9919240
GRUPPO TERMICO RACING Ø maggiorato ghisa c/testa scomposta						9921150	9921150
GRUPPO TERMICO RACING Ø maggiorato alluminio						9924130	9924130
INGRANAGGIO 6ª VELOCITÀ		AM6 1ª Versione				9919080	9919080
		AM6 2ª Versione				9931910	9931910
KIT ASPIRAZIONE COMPLETO TM24			9930910	9930910	9930910	9930910	9930910
KIT ASPIRAZIONE COMPLETO OKO 28			9931750	9931750	9931750	9931750	9931750
MAXI KIT RACING 85 cc ghisa Ø 49,5 corsa 44						9921450	9921450
MAXI KIT RACING 85 cc alluminio Ø 50 corsa 44						9924240	9924240
MOTORINO D'AVVIAMENTO							
SCARICO RACING							
SCARICO RACING Omologato							
SERIE DISCHI Frizione racing cellulosa/kevlar			9923190	9923190	9923190	9921180	9921180
SERIE DISCHI Standard						9920250	9920250
TRASDUTTORE Per volano Ducati 6 poli							
VALVOLA LAMELLARE						9906500	9906500
VALVOLA TPR						9931600	9931600

Fantic	Fantic	Gilera	Gilera	Gilera	Gilera	Gilera	Gilera	Gilera	Gilera	HM
Caballero Regolarità	Caballero Regolarità	Gsm H@K	RCR	RCR	RCR	SMT	SMT	SMT	SMT Racing	Baja, Derapage Basic
06-09	10-10	01-01	03-03	06-07	11-12	03-03	-	-	11-12	10-11
50cc 2T LC	50cc 2T LC	50cc 2T LC	50cc 2T LC	50cc 2T LC	50cc 2T LC	50cc 2T LC	50cc 2T LC	50cc 2T LC	50cc 2T LC	50cc 2T LC
AM 6	AM 6	EBE050	EBS050	D50B0	D50B0	EBS050	D50B0	D50B0	D50B0	AM 6
9921720	9921720									9921720
IM07033	IM07033									IM07033
IM07036	IM07036									IM07036
9921690	9921690									
9929180	9929180	9929190	9929190	9929190	9929190	9929190	9929190	9929190	9929190	9929180
9920020	9920020									9920020
9918550	9918550									9918550
9916770	9916770	9917400	9917400	9927100	9927100	9917400	9927100	9927100	9927100	9916770
9919250	9919250	9917390	9917390	9927020	9927020	9917390	9927020	9927020	9927020	9919250
9919240	9919240									9919240
9921150	9921150									9921150
9924130	9924130									9924130
9919080	9919080									9919080
9931910	9931910									9931910
9930910	9930910	9930910	9930910	9930910	9930910	9930910	9930910	9930910	9930910	9930910
9931750	9931750	9931750	9931750	9931750	9931750	9931750	9931750	9931750	9931750	9931750
9921450	9921450									9921450
9924240	9924240									9924240
										MA00018
										9924340
9921180	9921180	9923190	9923190	9923190	9923190	9923190	9923190	9923190	9923190	9921180
9920250	9920250									9920250
9906500	9906500									9906500
9931600	9931600									9931600

MOTO 50cc



HM	HM	HM	HM	HM	HM
CMC	CRE Baja RR, Derapage RR	CRE Baja RR, Derapage RR	CRE Baja, Derapage	CRE Baja, Derapage	CRE Six Competition
10-11	07-09	10-11	07-09	10-11	10-11
50cc 2T LC	50cc 2T LC	50cc 2T LC	50cc 2T LC	50cc 2T LC	50cc 2T LC
AM 6	AM 6	AM 6	AM 6	AM 6	AM 6

ALBERO MOTORE corsa 39 mm a piattelli pieni			9921720	9921720	9921720	9921720	9921720	9921720
BIELLA		Axe 16	IM07033	IM07033	IM07033	IM07033	IM07033	IM07033
		Axe 18	IM07036	IM07036	IM07036	IM07036	IM07036	IM07036
CENTRALINA digitale ad anticipo variabile volano Ducati 6 poli								
CUSCINETTI DI BANCO TPR Carbonitrurati		Serie	9929180	9929180	9929180	9929180	9929180	9929180
DESMODROMICO Cambio			9920020	9920020	9920020	9920020	9920020	9920020
FRIZIONE Denti dritti			9918550	9918550	9918550	9918550	9918550	9918550
GRUPPO TERMICO Ø standard ghisa			9916770	9916770	9916770	9916770	9916770	9916770
GRUPPO TERMICO Ø maggiorato ghisa			9919250	9919250	9919250	9919250	9919250	9919250
GRUPPO TERMICO RACING Ø maggiorato ghisa			9919240	9919240	9919240	9919240	9919240	9919240
GRUPPO TERMICO RACING Ø maggiorato ghisa c/testa scomposta			9921150	9921150	9921150	9921150	9921150	9921150
GRUPPO TERMICO RACING Ø maggiorato alluminio			9924130	9924130	9924130	9924130	9924130	9924130
INGRANAGGIO 6ª VELOCITÀ		AM6 1ª Versione	9919080	9919080	9919080	9919080	9919080	9919080
		AM6 2ª Versione	9931910	9931910	9931910	9931910	9931910	9931910
KIT ASPIRAZIONE COMPLETO TM24			9930910	9930910	9930910	9930910	9930910	9930910
KIT ASPIRAZIONE COMPLETO OKO 28			9931750	9931750	9931750	9931750	9931750	9931750
MAXI KIT RACING 85 cc ghisa Ø 49,5 corsa 44			9921450	9921450	9921450	9921450	9921450	9921450
MAXI KIT RACING 85 cc alluminio Ø 50 corsa 44			9924240	9924240	9924240	9924240	9924240	9924240
MOTORINO D'AVVIAMENTO				MA00018	MA00018	MA00018	MA00018	MA00018
SCARICO RACING								
SCARICO RACING Omologato			9924340	9924340	9924340	9924340	9924340	9924340
SERIE DISCHI Frizione racing cellulosa/kevlar			9921180	9921180	9921180	9921180	9921180	9921180
SERIE DISCHI Standard			9920250	9920250	9920250	9920250	9920250	9920250
TRASDUTTORE Per volano Ducati 6 poli								
VALVOLA LAMELLARE			9906500	9906500	9906500	9906500	9906500	9906500
VALVOLA TPR			9931600	9931600	9931600	9931600	9931600	9931600

HM	HM	HM	HM	HM	HM	Malaguti	Malaguti	Malaguti	Malaguti	Mbk
CRE Six, Baia, Derapage	CRE Six, Baia, Derapage	CRE Six, Baia, Derapage	CRE Six, Baia, Derapage	CRE Six, Derapage Competition	Derapage Competition	CNK Drakon	Fifty Evolution	XSM 50	XTM 50	X Limit
95-00	01-02	03-05	06-06	07-09	10-11	05-07	90-93	-00	-00	-00
50cc 2T LC	50cc 2T LC	50cc 2T LC	50cc 2T LC	50cc 2T LC	50cc 2T LC	50cc 2T LC	50cc 2T LC	50cc 2T LC	50cc 2T LC	50cc 2T LC
AM 6	AM 6	AM 6	AM 6	AM 6	AM 6	AM 6	AM 3-4-5	AM 6	AM 6	AM 6
9921720	9921720	9921720	9921720	9921720	9921720	9921720	9921720	9921720	9921720	9921720
IM07033	IM07033	IM07033	IM07033	IM07033	IM07033	IM07033	IM07033	IM07033	IM07033	IM07033
IM07036	IM07036	IM07036	IM07036	IM07036	IM07036	IM07036	IM07036	IM07036	IM07036	IM07036
9921690	9921690	9921690				9921690	9921690	9921690	9921690	9921690
9929180	9929180	9929180	9929180	9929180	9929180	9929180	9929180	9929180	9929180	9929180
9920020	9920020	9920020	9920020	9920020	9920020	9920020		9920020	9920020	9920020
9918550	9918550	9918550	9918550	9918550	9918550	9918550	9918550	9918550	9918550	9918550
9916770	9916770	9916770	9916770	9916770	9916770	9916770	9916770	9916770	9916770	9916770
9919250	9919250	9919250	9919250	9919250	9919250	9919250	9919250	9919250	9919250	9919250
9919240	9919240	9919240	9919240	9919240	9919240	9919240	9919240	9919240	9919240	9919240
9921150	9921150	9921150	9921150	9921150	9921150	9921150	9921150	9921150	9921150	9921150
9924130	9924130	9924130	9924130	9924130	9924130	9924130	9924130	9924130	9924130	9924130
9919080	9919080	9919080	9919080	9919080	9919080	9919080		9919080	9919080	9919080
9931910	9931910	9931910	9931910	9931910	9931910	9931910		9931910	9931910	9931910
9930910	9930910	9930910	9930910	9930910	9930910	9930910	9930910	9930910	9930910	9930910
9931750	9931750	9931750	9931750	9931750	9931750	9931750	9931750	9931750	9931750	9931750
9921450	9921450	9921450	9921450	9921450	9921450	9921450	9921450	9921450	9921450	9921450
9924240	9924240	9924240	9924240	9924240	9924240	9924240	9924240	9924240	9924240	9924240
MA00018		MA00018	MA00018		MA00018		MA00018			
								9921090	9921090	9921090
9924340	9924340	9924340	9924340	9924340	9924340					
9921180	9921180	9921180	9921180	9921180	9921180	9921180	9921180	9921180	9921180	9921180
9920250	9920250	9920250	9920250	9920250	9920250	9920250	9920250	9920250	9920250	9920250
9910150	9910150	9910150				9910150	9910150	9910150	9910150	9910150
9906500	9906500	9906500	9906500	9906500	9906500	9906500	9906500	9906500	9906500	9906500
9931600	9931600	9931600	9931600	9931600	9931600	9931600	9931600	9931600	9931600	9931600

MOTO 50cc



Mbk	Minarelli	Motorhispania	Motorhispania	Motorhispania	Motorhispania
X Power	AM 345 Moto-ri Minarelli	Furia 50	Furia Max 50	RX 50	RX 50 R
-00	-00	-00	-00	-00	-00
50cc 2T LC	50cc 2T LC	50cc 2T LC	50cc 2T LC	50cc 2T LC	50cc 2T LC
AM 6	AM 3-4-5	AM 6	AM 6	AM 6	AM 6

ALBERO MOTORE corsa 39 mm a piattelli pieni			9921720	9921720	9921720	9921720	9921720	9921720
BIELLA		Axe 16	IM07033	IM07033	IM07033	IM07033	IM07033	IM07033
		Axe 18	IM07036	IM07036	IM07036	IM07036	IM07036	IM07036
CENTRALINA digitale ad anticipo variabile volano Ducati 6 poli			9921690	9921690	9921690	9921690	9921690	9921690
CUSCINETTI DI BANCO TPR Carbonitrurati		Serie	9929180	9929180	9929180	9929180	9929180	9929180
DESMODROMICO Cambio			9920020		9920020	9920020	9920020	9920020
FRIZIONE Denti dritti			9918550	9918550	9918550	9918550	9918550	9918550
GRUPPO TERMICO Ø standard ghisa			9916770	9916770	9916770	9916770	9916770	9916770
GRUPPO TERMICO Ø maggiorato ghisa			9919250	9919250	9919250	9919250	9919250	9919250
GRUPPO TERMICO RACING Ø maggiorato ghisa			9919240	9919240	9919240	9919240	9919240	9919240
GRUPPO TERMICO RACING Ø maggiorato ghisa c/testa scomposta			9921150	9921150	9921150	9921150	9921150	9921150
GRUPPO TERMICO RACING Ø maggiorato alluminio			9924130	9924130	9924130	9924130	9924130	9924130
INGRANAGGIO 6ª VELOCITÀ		AM6 1ª Versione	9919080		9919080	9919080	9919080	9919080
		AM6 2ª Versione	9931910		9931910	9931910	9931910	9931910
KIT ASPIRAZIONE COMPLETO TM24			9930910	9930910	9930910	9930910	9930910	9930910
KIT ASPIRAZIONE COMPLETO OKO 28			9931750	9931750	9931750	9931750	9931750	9931750
MAXI KIT RACING 85 cc ghisa Ø 49,5 corsa 44			9921450	9921450	9921450	9921450	9921450	9921450
MAXI KIT RACING 85 cc alluminio Ø 50 corsa 44			9924240	9924240	9924240	9924240	9924240	9924240
MOTORINO D'AVVIAMENTO								
SCARICO RACING								
SCARICO RACING Omologato			9926880					
SERIE DISCHI Frizione racing cellulosa/kevlar			9921180	9921180	9921180	9921180	9921180	9921180
SERIE DISCHI Standard			9920250	9920250	9920250	9920250	9920250	9920250
TRASDUTTORE Per volano Ducati 6 poli			9910150	9910150	9910150	9910150	9910150	9910150
VALVOLA LAMELLARE			9906500	9906500	9906500	9906500	9906500	9906500
VALVOLA TPR			9931600	9931600	9931600	9931600	9931600	9931600

Peugeot	Peugeot	Peugeot	Rieju	Rieju	Rieju	Rieju	Rieju	Rieju	Rieju	Rieju
Supermotard	XP6 Trail S/ Avv. Elettrico	XR6 Racing Cat. C/avv.elett.	MRT 50	MRT 50 PRO	MRT 50 PRO SM	MRT 50 SM	MRX 50	MRX 50 PRO	RR 50	RS1 50
-00	-00	-00	-00	-00	-00	-00	-00	-00	-00	-00
50cc 2T LC	50cc 2T LC	50cc 2T LC	50cc 2T LC	50cc 2T LC	50cc 2T LC	50cc 2T LC	50cc 2T LC	50cc 2T LC	50cc 2T LC	50cc 2T LC
AM 6	AM 6	AM 6	AM 6	AM 6	AM 6	AM 6	AM 6	AM 6	AM 6	AM 6
9921720	9921720	9921720	9921720	9921720	9921720	9921720	9921720	9921720	9921720	9921720
IM07033	IM07033	IM07033	IM07033	IM07033	IM07033	IM07033	IM07033	IM07033	IM07033	IM07033
IM07036	IM07036	IM07036	IM07036	IM07036	IM07036	IM07036	IM07036	IM07036	IM07036	IM07036
9921690	9921690	9921690					9921690	9921690	9921690	9921690
9929180	9929180	9929180	9929180	9929180	9929180	9929180	9929180	9929180	9929180	9929180
9920020	9920020	9920020	9920020	9920020	9920020	9920020	9920020	9920020	9920020	9920020
9918550	9918550	9918550	9918550	9918550	9918550	9918550	9918550	9918550	9918550	9918550
9916770	9916770	9916770	9916770	9916770	9916770	9916770	9916770	9916770	9916770	9916770
9919250	9919250	9919250	9919250	9919250	9919250	9919250	9919250	9919250	9919250	9919250
9919240	9919240	9919240	9919240	9919240	9919240	9919240	9919240	9919240	9919240	9919240
9921150	9921150	9921150	9921150	9921150	9921150	9921150	9921150	9921150	9921150	9921150
9924130	9924130	9924130	9924130	9924130	9924130	9924130	9924130	9924130	9924130	9924130
9919080	9919080	9919080	9919080	9919080	9919080	9919080	9919080	9919080	9919080	9919080
9931910	9931910	9931910	9931910	9931910	9931910	9931910	9931910	9931910	9931910	9931910
9930910	9930910	9930910	9930910	9930910	9930910	9930910	9930910	9930910	9930910	9930910
9931750	9931750	9931750	9931750	9931750	9931750	9931750	9931750	9931750	9931750	9931750
9921450	9921450	9921450	9921450	9921450	9921450	9921450	9921450	9921450	9921450	9921450
9924240	9924240	9924240	9924240	9924240	9924240	9924240	9924240	9924240	9924240	9924240
9921180	9921180	9921180	9921180	9921180	9921180	9921180	9921180	9921180	9921180	9921180
9920250	9920250	9920250	9920250	9920250	9920250	9920250	9920250	9920250	9920250	9920250
9910150	9910150	9910150	9910150	9910150	9910150	9910150	9910150	9910150	9910150	9910150
9906500	9906500	9906500	9906500	9906500	9906500	9906500	9906500	9906500	9906500	9906500
9931600	9931600	9931600	9931600	9931600	9931600	9931600	9931600	9931600	9931600	9931600

MOTO 50cc



Rieju	Rieju	Rieju	Rieju	Rieju	Rieju
RS2 50 Matrix	RS2 50 Matrix Pro	RS2 Naked 50	SMX 50 E.S./K.S.	SMX 50 PRO E.S./K.S.	Spike 50
-00	-00	-00	-00	-00	-00
50cc 2T LC	50cc 2T LC	50cc 2T LC	50cc 2T LC	50cc 2T LC	50cc 2T LC
AM 6	AM 6	AM 6	AM 6	AM 6	AM 6

ALBERO MOTORE corsa 39 mm a piattelli pieni			9921720	9921720	9921720	9921720	9921720	9921720	9921720
BIELLA		Axe 16	IM07033	IM07033	IM07033	IM07033	IM07033	IM07033	IM07033
		Axe 18	IM07036	IM07036	IM07036	IM07036	IM07036	IM07036	IM07036
CENTRALINA digitale ad anticipo variabile volano Ducati 6 poli			9921690	9921690	9921690	9921690	9921690	9921690	9921690
CUSCINETTI DI BANCO TPR Carbonitrurati		Serie	9929180	9929180	9929180	9929180	9929180	9929180	9929180
DESMODROMICO Cambio			9920020	9920020	9920020	9920020	9920020	9920020	9920020
FRIZIONE Denti dritti			9918550	9918550	9918550	9918550	9918550	9918550	9918550
GRUPPO TERMICO Ø standard ghisa			9916770	9916770	9916770	9916770	9916770	9916770	9916770
GRUPPO TERMICO Ø maggiorato ghisa			9919250	9919250	9919250	9919250	9919250	9919250	9919250
GRUPPO TERMICO RACING Ø maggiorato ghisa			9919240	9919240	9919240	9919240	9919240	9919240	9919240
GRUPPO TERMICO RACING Ø maggiorato ghisa c/testa scomposta			9921150	9921150	9921150	9921150	9921150	9921150	9921150
GRUPPO TERMICO RACING Ø maggiorato alluminio			9924130	9924130	9924130	9924130	9924130	9924130	9924130
INGRANAGGIO 6ª VELOCITÀ		AM6 1ª Versione	9919080	9919080	9919080	9919080	9919080	9919080	9919080
		AM6 2ª Versione	9931910	9931910	9931910	9931910	9931910	9931910	9931910
KIT ASPIRAZIONE COMPLETO TM24			9930910	9930910	9930910	9930910	9930910	9930910	9930910
KIT ASPIRAZIONE COMPLETO OKO 28			9931750	9931750	9931750	9931750	9931750	9931750	9931750
MAXI KIT RACING 85 cc ghisa Ø 49,5 corsa 44			9921450	9921450	9921450	9921450	9921450	9921450	9921450
MAXI KIT RACING 85 cc alluminio Ø 50 corsa 44			9924240	9924240	9924240	9924240	9924240	9924240	9924240
MOTORINO D'AVVIAMENTO									
SCARICO RACING									
SCARICO RACING Omologato									
SERIE DISCHI Frizione racing cellulosa/kevlar			9921180	9921180	9921180	9921180	9921180	9921180	9921180
SERIE DISCHI Standard			9920250	9920250	9920250	9920250	9920250	9920250	9920250
TRASDUTTORE Per volano Ducati 6 poli			9910150	9910150	9910150	9910150	9910150	9910150	9910150
VALVOLA LAMELLARE			9906500	9906500	9906500	9906500	9906500	9906500	9906500
VALVOLA TPR			9931600	9931600	9931600	9931600	9931600	9931600	9931600

Sherco	Sherco	Yamaha	Yamaha	Yamaha	Yamaha	Yamaha	Yamaha	Yamaha	Yamaha	Yamaha
HRD Enduro 50	HRD Motard 50	DT R	DT R	DT R	DT R	DT RSM	DT X	DT X	DT X	TZR
-00	-00	03-05	06-06	07-07	08-10	03-05	06-06	07-07	08-10	03-05
50cc 2T LC	50cc 2T LC	50cc 2T LC	50cc 2T LC	50cc 2T LC	50cc 2T LC	50cc 2T LC	50cc 2T LC	50cc 2T LC	50cc 2T LC	50cc 2T LC
AM 6	AM 6	AM 6	AM 6	AM 6	AM 6	AM 6	AM 6	AM 6	AM 6	AM 6
9921720	9921720	9921720	9921720	9921720	9921720	9921720	9921720	9921720	9921720	9921720
IM07033	IM07033	IM07033	IM07033	IM07033	IM07033	IM07033	IM07033	IM07033	IM07033	IM07033
IM07036	IM07036	IM07036	IM07036	IM07036	IM07036	IM07036	IM07036	IM07036	IM07036	IM07036
9921690	9921690	9921690	9921690			9921690	9921690			
9929180	9929180	9929180	9929180	9929180	9929180	9929180	9929180	9929180	9929180	9929180
9920020	9920020	9920020	9920020	9920020	9920020	9920020	9920020	9920020	9920020	9920020
9918550	9918550	9918550	9918550	9918550	9918550	9918550	9918550	9918550	9918550	9918550
9916770	9916770	9916770	9916770	9916770	9916770	9916770	9916770	9916770	9916770	9916770
9919250	9919250	9919250	9919250	9919250	9919250	9919250	9919250	9919250	9919250	9919250
9919240	9919240	9919240	9919240	9919240	9919240	9919240	9919240	9919240	9919240	9919240
9921150	9921150	9921150	9921150	9921150	9921150	9921150	9921150	9921150	9921150	9921150
9924130	9924130	9924130	9924130	9924130	9924130	9924130	9924130	9924130	9924130	9924130
9919080	9919080	9919080	9919080	9919080	9919080	9919080	9919080	9919080	9919080	9919080
9931910	9931910	9931910	9931910	9931910	9931910	9931910	9931910	9931910	9931910	9931910
9930910	9930910	9930910	9930910	9930910	9930910	9930910	9930910	9930910	9930910	9930910
9931750	9931750	9931750	9931750	9931750	9931750	9931750	9931750	9931750	9931750	9931750
9921450	9921450	9921450	9921450	9921450	9921450	9921450	9921450	9921450	9921450	9921450
9924240	9924240	9924240	9924240	9924240	9924240	9924240	9924240	9924240	9924240	9924240
										MA00018
		9921090	9921090	9921090	9921090	9921090	9921090	9921090	9921090	
										9926880
9921180	9921180	9921180	9921180	9921180	9921180	9921180	9921180	9921180	9921180	9921180
9920250	9920250	9920250	9920250	9920250	9920250	9920250	9920250	9920250	9920250	9920250
9910150	9910150	9910150	9910150			9910150	9910150			
9906500	9906500	9906500	9906500	9906500	9906500	9906500	9906500	9906500	9906500	9906500
9931600	9931600	9931600	9931600	9931600	9931600	9931600	9931600	9931600	9931600	9931600

MOTO 50cc



Yamaha	Yamaha	Yamaha	Yamaha	Yamaha	Yamaha
TZR	TZR	TZR	TZR	TZR	TZR RR
06-06	07-07	08-08	10-10	11-11	05-05
50cc 2T LC	50cc 2T LC	50cc 2T LC	50cc 2T LC	50cc 2T LC	50cc 2T LC
AM 6	AM 6	AM 6	AM 6	AM 6	AM 6

ALBERO MOTORE corsa 39 mm a piattelli pieni			9921720	9921720	9921720	9921720	9921720	9921720
BIELLA		Axe 16	IM07033	IM07033	IM07033	IM07033	IM07033	IM07033
		Axe 18	IM07036	IM07036	IM07036	IM07036	IM07036	IM07036
CENTRALINA digitale ad anticipo variabile volano Ducati 6 poli								
CUSCINETTI DI BANCO TPR Carbonitrurati		Serie	9929180	9929180	9929180	9929180	9929180	9929180
DESMODROMICO Cambio			9920020	9920020	9920020	9920020	9920020	9920020
FRIZIONE Denti dritti			9918550	9918550	9918550	9918550	9918550	9918550
GRUPPO TERMICO Ø standard ghisa			9916770	9916770	9916770	9916770	9916770	9916770
GRUPPO TERMICO Ø maggiorato ghisa			9919250	9919250	9919250	9919250	9919250	9919250
GRUPPO TERMICO RACING Ø maggiorato ghisa			9919240	9919240	9919240	9919240	9919240	9919240
GRUPPO TERMICO RACING Ø maggiorato ghisa c/testa scomposta			9921150	9921150	9921150	9921150	9921150	9921150
GRUPPO TERMICO RACING Ø maggiorato alluminio			9924130	9924130	9924130	9924130	9924130	9924130
INGRANAGGIO 6ª VELOCITÀ		AM6 1ª Versione	9919080	9919080	9919080	9919080		9919080
		AM6 2ª Versione	9931910	9931910	9931910	9931910		9931910
KIT ASPIRAZIONE COMPLETO TM24			9930910	9930910	9930910	9930910	9930910	9930910
KIT ASPIRAZIONE COMPLETO OKO 28			9931750	9931750	9931750	9931750	9931750	9931750
MAXI KIT RACING 85 cc ghisa Ø 49,5 corsa 44			9921450	9921450	9921450	9921450	9921450	9921450
MAXI KIT RACING 85 cc alluminio Ø 50 corsa 44			9924240	9924240	9924240	9924240	9924240	9924240
MOTORINO D'AVVIAMENTO			MA00018	MA00018	MA00018	MA00018	MA00018	MA00018
SCARICO RACING								
SCARICO RACING Omologato			9926880	9926880	9926880	9926880	9926880	9926880
SERIE DISCHI Frizione racing cellulosa/kevlar			9921180	9921180	9921180	9921180	9921180	9921180
SERIE DISCHI Standard			9920250	9920250	9920250	9920250	9920250	9920250
TRASDUTTORE Per volano Ducati 6 poli								
VALVOLA LAMELLARE			9906500	9906500	9906500	9906500	9906500	9906500
VALVOLA TPR			9931600	9931600	9931600	9931600	9931600	9931600

***Elevate prestazioni
Massima affidabilità***

motorparts.it

follow us

facebook



SCOOTER 50cc



Aprilia	Aprilia	Aprilia	Aprilia	Aprilia	Aprilia
Amico	Amico	Amico GL/GLE	Amico LX/Sport/Cat	Area 51	Gulliver
94-94	96-98	93-95	92-93	98-00	95-98
50cc 2T AC	50cc 2T AC	50cc 2T AC	50cc 2T AC	50cc 2T LC	50cc 2T AC
CW	CW	CW	CW	MA	MY

ALBERO MOTORE		Con Cuscinetti e Paraoli	IM07058	IM07058	IM07058	IM07058	IM07059	IM07059
		Senza Cuscinetti e Paraoli	IM07013	IM07013	IM07013	IM07013	IM07014	IM07014
ACCENSIONE		Fissa					9910100	9910100
		Variabile					9909230	9909230
		Digitale						
CAMPANA FRIZIONE							9924940	9924940
CINGHIA DI TRASMISSIONE		Top	9907770	9907770	9907770	9907770	9907770	9907770
		Mitsuboshi	9935270	9935270	9935270	9935270	9935270	9935270
CONVERTITORE DI COPPIA			9923030	9923030	9923030	9923030	9923030	9923030
FRIZIONE CENTRIFUGA		Interno Ø 105	9911060	9911060	9911060	9911060	9911060	9911060
		Interno Ø 107	9910020	9910020	9910020	9910020	9910020	9910020
GRUPPO TERMICO		Ø Standard						
		Magg. c/testa						
		Magg. s/testa						
		Modifica da AC a LC						9911090
GRUPPO TERMICO BLACK TROPHY		Ø Standard	9931170	9931170	9931170	9931170	9931110	9931140
		Ø Maggiorato	9931370	9931370	9931370	9931370	9931310	9931340
MOTORINO D'AVVIAMENTO			MA00001	MA00001	MA00001	MA00001	MA00001	MA00001
RAPPORTO ALLUNGATO		Primari	9913300	9913300	9913300	9913300	9913300	9913300
		Secondari					9909520	
SCARICO POWERED 2		Omologato						
SCARICO HP 2		Omologato						
VALVOLA LAMELLARE			9906520	9906520	9906520	9906520	9908370	9908370
VARIOTOP		TPR c/cinghia	9931670	9931670	9931670	9931670	9931670	9931670
		TPR s/cinghia	9931650	9931650	9931650	9931650	9931650	9931650

Aprilia	Aprilia	Aprilia	Aprilia	Aprilia	Aprilia	Aprilia	Aprilia	Aprilia	Aprilia	Aprilia
Gulliver LC	Mojito	Mojito Custom	Mojito Retrò	Rally	Rally Liquid Cooled	SR (Orizzontale)	SR (Verticale)	SR DITECH EU2	SR Factory Kat	SR Factory Kat I.E.
96-98	-	99-03	99-03	95-03	96-99	94-96	93-93	02-03	-	-
50cc 2T LC	50cc 2T AC	50cc 2T AC	50cc 2T AC	50cc 2T AC	50cc 2T LC	50cc 2T AC	50cc 2T AC	50cc 2T-IE LC	50cc 2T AC	50cc 2T AC
MA	Motore Piaggio	Motore Aprilia	Motore Aprilia	MY	MA	MY	CW	Motore Aprilia		
IM07059	IM07060			IM07059	IM07059	IM07059	IM07058			
IM07014	IM07015			IM07014	IM07014	IM07014	IM07013	IM07044		
9910100				9910100	9910100	9910100				
9909230				9909230	9909230	9909230				
9924940	9924950			9924940	9924940	9924940				
9907770	9922030	9920440	9920440	9907770	9907770	9907770	9907770	9920440		
9935270	9935830	9935820	9935820	9935270	9935270	9935270	9935270	9935820		
9923030	9923150			9923030	9923030	9923030	9923030			
9911060				9911060	9911060	9911060	9911060			
9910020	9910020			9910020	9910020	9910020	9910020			
	9914500									
				9911090		9911090				
9931110				9931140	9931110	9931140	9931170			
9931310	9931250			9931340	9931310	9931340	9931370			
MA00001	MA00002			MA00001	MA00001	MA00001	MA00001			
9913300				9913300	9913300	9913300	9913300			
9909520					9909520	9909520				
										9932990
									9933300	
9908370	9910930			9908370	9908370	9908370	9906520			
9931670	9931300			9931670	9931670	9931670	9931670			
9931650	9927610			9931650	9931650	9931650	9931650			

SCOOTER 50cc



Aprilia	Aprilia	Aprilia	Aprilia	Aprilia	Aprilia
SR H2O DI-TECH	SR Liquid Cooled	SR R	SR R FACTORY Carburatore	SR R FACTORY IE	SR R FACTORY Motore Aprilia
00-03	94-96	04-09	-	-	05-05
50cc 2T-IE LC	50cc 2T LC	50cc 2T LC	50cc 2T LC	50cc 2T LC	50cc 2T-IE LC
Motore Aprilia	MA	Motore Piaggio	Motore Piaggio	Motore Piaggio	Motore Aprilia

ALBERO MOTORE		Con Cuscinetti e Paraoli		IM07059	IM07060	IM07060	IM07060	
		Senza Cuscinetti e Paraoli	IM07044	IM07014	IM07015	IM07015	IM07015	IM07044
ACCENSIONE		Fissa		9910100				
		Variabile		9909230				
		Digitale						
CAMPANA FRIZIONE				9924940	9924950	9924950	9924950	
CINGHIA DI TRASMISSIONE		Top	9920440	9907770	9922030	9922030	9922030	9920440
		Mitsuboshi	9935820	9935270	9935830	9935830	9935830	9935830
CONVERTITORE DI COPPIA				9923030	9923150	9923150	9923150	
FRIZIONE CENTRIFUGA		Interno Ø 105		9911060				
		Interno Ø 107		9910020	9910020	9910020	9910020	
GRUPPO TERMICO		Ø Standard			9916580	9916580	9916580	
		Magg. c/testa						
		Magg. s/testa						
		Modifica da AC a LC						
GRUPPO TERMICO BLACK TROPHY		Ø Standard		9931110				
		Ø Maggiorato		9931310	9931270	9931270	9931270	9931270
MOTORINO D'AVVIAMENTO				MA00001	MA00015	MA00002	MA00015	
RAPPORTO ALLUNGATO		Primari		9913300				
		Secondari		9909520				
SCARICO POWERED 2		Omologato						
SCARICO HP 2		Omologato						
VALVOLA LAMELLARE				9908370	9910930	9910930	9910930	
VARIOTOP		TPR c/cinghia		9931670	9931300	9931300	9931300	
		TPR s/cinghia		9931650	9927610	9927610	9927610	

Aprilia	Aprilia	Aprilia	Aprilia	Aprilia	Aprilia	Aprilia	Aprilia	Aprilia	Aprilia	Aprilia
SR Racing	SR Recing	SR Sport Pro Kat I.E.	SR Stealth	SR Stealth	SR Street Carburatore	SR WWW	Scarabeo	Scarabeo	Scarabeo	Scarabeo
-	97-99	-	97-99	-	03-12	97-01	93-97	98-98	99-99	00-05
50cc 2T AC	50cc 2T LC	50cc 2T AC	50cc 2T LC	50cc 2T AC	50cc 2T LC	50cc 2T AC	50cc 2T AC	50cc 2T AC	50cc 2T AC	50cc 2T AC
	MA		MA		Motore Piaggio	MY	MY	MY	MY	MY
	IM07059		IM07059		IM07060	IM07059	IM07059	IM07059	IM07059	IM07059
	IM07014		IM07014		IM07015	IM07014	IM07014	IM07014	IM07014	IM07014
	9910100		9910100			9910100	9910100	9910100	9910100	9910100
	9909230		9909230			9909230	9909230	9909230	9909230	9909230
	9924940		9924940		9924950	9924940	9924940	9924940	9924940	9924940
	9907770		9907770		9922030	9907770	9907770	9907770	9907770	9907770
	9935270		9935270		9935830	9935270	9935270	9935270	9935270	9935270
	9923030		9923030		9923150	9923030	9923030	9923030	9923030	9923030
	9911060		9911060			9911060	9911060	9911060	9911060	9911060
	9910020		9910020		9910020	9910020	9910020	9910020	9910020	9910020
					9916580					
						9911090	9911090	9911090	9911090	9911090
	9931110		9931110			9931140	9931140	9931140	9931140	9931140
	9931310		9931310		9931270	9931340	9931340	9931340	9931340	9931340
	MA00001		MA00001		MA00002	MA00001	MA00001	MA00001	MA00001	MA00001
	9913300		9913300			9913300	9913300	9913300	9913300	9913300
	9909520		9909520							
9933380		9933300		9933380						
	9908370		9908370		9910930	9908370	9908370	9908370	9908370	9908370
	9931670		9931670		9931300	9931670	9931670	9931670	9931670	9931670
	9931650		9931650		9927610	9931650	9931650	9931650	9931650	9931650

SCOOTER 50cc



Aprilia	Aprilia	Aprilia	Aprilia	Aprilia	Aprilia
Scarabeo 2T EU2 Motore Piaggio	Scarabeo 2T Net	Scarabeo 2T Net	Scarabeo 4T	Scarabeo 4T 4V	Scarabeo 4T 4V NET
10-12	09-09	10-10	02-06	10-12	09-09
50cc 2T AC	50cc 2T AC	50cc 2T AC	50cc 4T AC	50cc 4T-4V AC	50cc 4T-4V AC
Motore Piaggio	Motore Piaggio	Motore Piaggio	Motore Piaggio	Motore Piaggio	Motore Piaggio

ALBERO MOTORE		Con Cuscinetti e Paraoli	IM07060	IM07060	IM07060			
		Senza Cuscinetti e Paraoli	IM07015	IM07015	IM07015			
ACCENSIONE		Fissa						
		Variabile						
		Digitale						
CAMPANA FRIZIONE			9924950	9924950	9924950	9924950	9924950	9924950
CINGHIA DI TRASMISSIONE		Top						
		Mitsuboshi						
CONVERTITORE DI COPPIA			9923150	9923150	9923150	9923150	9923150	9923150
FRIZIONE CENTRIFUGA		Interno Ø 105						
		Interno Ø 107	9910020	9910020	9910020	9910020	9910020	9910020
GRUPPO TERMICO		Ø Standard	9914500	9914500	9914500			
		Magg. c/testa						
		Magg. s/testa				9925150	9928300	9928300
		Modifica da AC a LC						
GRUPPO TERMICO BLACK TROPHY		Ø Standard						
		Ø Maggiorato	9931250	9931250	9931250			
MOTORINO D'AVVIAMENTO			MA00002	MA00002	MA00002	MA00015	MA00015	MA00015
RAPPORTO ALLUNGATO		Primari						
		Secondari						
SCARICO POWERED 2								
SCARICO HP 2								
VALVOLA LAMELLARE			9910930	9910930	9910930			
VARIOTOP		TPR c/cinghia						
		TPR s/cinghia	9927610	9927610	9927610			

SCOOTER 50cc

Aprilia	Aprilia	Aprilia	Aprilia	Aprilia	Aprilia	Aprilia	Aprilia	Aprilia	Aprilia	Aprilia
Scarabeo 4T 4V NET	Scarabeo 4T Restyling EU3	Scarabeo DITECH	Scarabeo Quattro	Scarabeo Street	Scarabeo Street	Scarabeo Street 2T Restyling	Sonic	Sonic GP	Sport City One 2T	Sport City One 4T
10-10	06-09	01-04	09-09	05-06	-	06-09	98-07	98-08	08-11	08-10
50cc 4T-4V AC	50cc 4T AC	50cc 2T-IE AC	50cc 4T-4V AC	50cc 2T AC	50cc 2T AC	50cc 2T AC	50cc 2T AC	50cc 2T LC	50cc 2T AC	50cc 4T AC
Motore Piaggio	Motore Piaggio	Motore Aprilia	Motore Piaggio	Motore Piaggio		Motore Piaggio	CY	CA	Motore Piaggio	Motore Piaggio
				IM07060		IM07060	IM07059	IM07059	IM07060	
		IM07044		IM07015		IM07015	IM07014	IM07014	IM07015	
							9910100	9910100		
							9909230	9909230		
9924950	9924950		9924950	9924950		9924950	9924940	9924940	9924950	9924950
		9920440					9907900	9907900		
							9935340	9935340		
9923150	9923150		9923150	9923150		9923150	9923030	9923030	9923150	9923150
							9911060	9911060		
9910020	9910020		9910020	9910020		9910020	9910020	9910020	9910020	9910020
				9914500		9914500			9914500	
9928300	9925150		9928300							9925150
							9911090			
							9931140	9931110		
				9931250		9931250	9931340	9931310	9931250	
MA00015	MA00015		MA00015	MA00002		MA00002	MA00001	MA00001	MA00002	MA00015
							9913310	9913310		
					9932980					
				9910930		9910930	9908370	9908370	9910930	
							9931690	9931690		
				9927610		9927610	9931650	9931650	9927610	

SCOOTER 50cc



Atala	BSV	BSV	BSV	Baotian	Baotian
Carosello	Dio GP	Dio SP	Dio ZX	Eco Bike	Rebel
-00	-00	-00	-00	-00	-00
50cc 2T AC	50cc 2T AC	50cc 2T AC	50cc 2T AC	50cc 4T AC	50cc 4T AC
MY	Motore Honda	Motore Honda	Motore Honda	Tipo Kymco	Tipo Kymco

ALBERO MOTORE		Con Cuscinetti e Paraoli	IM07059					
		Senza Cuscinetti e Paraoli	IM07014					
ACCENSIONE		Fissa						
		Variabile						
		Digitale						
CAMPANA FRIZIONE			9924940					
CINGHIA DI TRASMISSIONE		Top	9907770					
		Mitsuboshi	9935270					
CONVERTITORE DI COPPIA			9923030					
FRIZIONE CENTRIFUGA		Interno Ø 105	9911060					
		Interno Ø 107	9910020	9910020	9910020	9910020		
GRUPPO TERMICO		Ø Standard						
		Magg. c/testa						
		Magg. s/testa					9925140	9925140
		Modifica da AC a LC	9911090					
GRUPPO TERMICO BLACK TROPHY		Ø Standard	9931140					
		Ø Maggiorato	9931340					
MOTORINO D'AVVIAMENTO			MA00001					
RAPPORTO ALLUNGATO		Primari	9913300					
		Secondari						
SCARICO POWERED 2								
SCARICO HP 2								
VALVOLA LAMELLARE			9908370	9912550	9912550	9912550		
VARIOTOP		TPR c/cinghia	9931670					
		TPR s/cinghia	9931650					

Baotian	Baotian	Benelli	Benelli	Benelli	Benelli	Benelli	Benelli	Benelli	Benelli	Benelli
Rochy	Tanco	491 GT	491 RR	491 Racing	491 SP	491 ST	491 Sport	K2	K2 Liquid Cooled	Naked
-00	-00	98-99	99-01	98-99	99-99	99-01	98-99	98-01	98-01	02-02
50cc 4T AC	50cc 4T AC	50cc 2T AC	50cc 2T LC	50cc 2T LC	50cc 2T LC	50cc 2T AC	50cc 2T LC	50cc 2T AC	50cc 2T LC	50cc 2T AC
Tipo Kymco	Tipo Kymco	MY	MA	MA	MA	MY	MA	MY	MA	MY
		IM07059	IM07059	IM07059	IM07059	IM07059	IM07059	IM07059	IM07059	IM07059
		IM07014	IM07014	IM07014	IM07014	IM07014	IM07014	IM07014	IM07014	IM07014
		9910100	9910100	9910100	9910100	9910100	9910100	9910100	9910100	9910100
		9909230	9909230	9909230	9909230	9909230	9909230	9909230	9909230	9909230
		9924940	9924940	9924940	9924940	9924940	9924940	9924940	9924940	9924940
		9907770	9907770	9907770	9907770	9907770	9907770	9907770	9907770	9907770
		9935270	9935270	9935270	9935270	9935270	9935270	9935270	9935270	9935270
		9923030	9923030	9923030	9923030	9923030	9923030	9923030	9923030	9923030
		9911060	9911060	9911060	9911060	9911060	9911060	9911060	9911060	9911060
		9910020	9910020	9910020	9910020	9910020	9910020	9910020	9910020	9910020
9925140	9925140									
		9911090				9911090		9911090		9911090
		9931140	9931110	9931110	9931110	9931140	9931110	9931140	9931110	9931140
		9931340	9931310	9931310	9931310	9931340	9931310	9931340	9931310	9931340
		MA00001	MA00001	MA00001	MA00001	MA00001	MA00001	MA00001	MA00001	MA00001
		9913300	9913300	9913300	9913300	9913300	9913300	9913300	9913300	9913300
		9909520	9909520	9909520	9909520	9909520	9909520			
		9908370	9908370	9908370	9908370	9908370	9908370	9908370	9908370	9908370
		9931670	9931670	9931670	9931670	9931670	9931670	9931670	9931670	9931670
		9931650	9931650	9931650	9931650	9931650	9931650	9931650	9931650	9931650

SCOOTER 50cc



Benelli	Benelli	Benelli	Benelli	Benelli	Benelli
Pepe	Pepe	Pepe LX	Pepe LX	Pepe Old	Pepe Old
99-01	10-10	03-04	07-09	07-09	11-11
50cc 2T AC	50cc 2T AC	50cc 2T AC	50cc 2T AC	50cc 2T AC	50cc 2T AC
MY	Tipo Keeway	MY	Tipo Keeway	Tipo Keeway	Tipo Keeway

ALBERO MOTORE		Con Cuscinetti e Paraoli	IM07059		IM07059					
		Senza Cuscinetti e Paraoli	IM07014		IM07014					
ACCENSIONE		Fissa	9910100		9910100					
		Variabile	9909230		9909230					
		Digitale								
CAMPANA FRIZIONE			9924940		9924940					
CINGHIA DI TRASMISSIONE		Top	9907770	9913280	9907770	9913280	9913280	9913280	9913280	
		Mitsuboshi	9935270	9935800	9935270	9935800	9935800	9935800	9935800	
CONVERTITORE DI COPPIA			9923030	9923030	9923030	9923030	9923030	9923030	9923030	
FRIZIONE CENTRIFUGA		Interno Ø 105	9911060		9911060					
		Interno Ø 107	9910020		9910020					
GRUPPO TERMICO		Ø Standard		9925650		9925650	9925650	9925650	9925650	
		Magg. c/testa		9924890		9924890	9924890	9924890	9924890	
		Magg. s/testa								
		Modifica da AC a LC	9911090		9911090					
GRUPPO TERMICO BLACK TROPHY		Ø Standard	9931140		9931140					
		Ø Maggiorato	9931340		9931340					
MOTORINO D'AVVIAMENTO			MA00001		MA00001					
RAPPORTO ALLUNGATO		Primari	9913300		9913300					
		Secondari	9909520		9909520					
SCARICO POWERED 2		Omologato								
SCARICO HP 2		Omologato								
VALVOLA LAMELLARE			9908370		9908370					
VARIOTOP		TPR c/cinghia	9931670		9931670					
		TPR s/cinghia	9931650	9924900	9931650	9924900	9924900	9924900	9924900	

Benelli	Benelli	Benelli	Beta	Beta	Beta	Beta	Beta	Beta	Beta	Beta
Quattronox	Quattronox	Quattronox	Ark	Ark LC	Chrono	Chrono	Eikon	Quadra	Quadra	Tempo
08-09	10-10	11-11	96-08	96-08	96-96	-00	99-03	95-95	-00	95-95
50cc 2T AC	50cc 2T AC	50cc 2T AC	50cc 2T AC	50cc 2T LC	50cc 2T AC	50cc 2T AC	50cc 2T LC	50cc 2T AC	50cc 2T AC	50cc 2T AC
Tipo Keeway	Tipo Keeway	Tipo Keeway	MY	MA	MY	MY	MA	MY	MY	MY
			IM07059	IM07059	IM07059	IM07059	IM07059	IM07059	IM07059	IM07059
			IM07014	IM07014	IM07014	IM07014	IM07014	IM07014	IM07014	IM07014
						9910100	9910100		9910100	
			9909300	9909300	9909300	9909230		9909300	9909230	9909300
			9924940	9924940	9924940	9924940	9924940	9924940	9924940	9924940
9913280	9913280	9913280	9907770	9907770	9907770	9907770	9907770	9907770	9907770	9907770
9935800	9935800	9935800	9935270	9935270	9935270	9935270	9935270	9935270	9935270	9935270
9923030	9923030	9923030	9923030	9923030	9923030	9923030	9923030	9923030	9923030	9923030
			9911060	9911060	9911060	9911060	9911060	9911060	9911060	9911060
			9910020	9910020	9910020	9910020	9910020	9910020	9910020	9910020
9925650	9925650	9925650								
9924890	9924890	9924890								
			9911090		9911090	9911090		9911090	9911090	9911090
			9931140	9931110	9931140	9931140	9931110	9931140	9931140	9931140
			9931340	9931310	9931340	9931340	9931310	9931340	9931340	9931340
			MA00001	MA00001	MA00001	MA00001	MA00001	MA00001	MA00001	MA00001
			9913300	9913300	9913300	9913300	9913300	9913300	9913300	9913300
				9909520			9909520			
			9908370	9908370	9908370	9908370	9908370	9908370	9908370	9908370
			9931670	9931670	9931670	9931670	9931670	9931670	9931670	9931670
9924900	9924900	9924900	9931650	9931650	9931650	9931650	9931650	9931650	9931650	9931650

SCOOTER 50cc



Beta	CPI	CPI	CPI	CPI	Derbi
Tempo	Aragon	Hussar	Oliver	Pop Corn	Atlantis
-00	03-03	03-03	03-03	03-03	-
50cc 2T AC	50cc 2T AC	50cc 2T AC	50cc 2T AC	50cc 2T AC	50cc 2T AC
MY	Tipo Keeway	Tipo Keeway	Tipo Keeway	Tipo Keeway	

ALBERO MOTORE		Con Cuscinetti e Paraoli	IM07059					
		Senza Cuscinetti e Paraoli	IM07014					
ACCENSIONE		Fissa	9910100					
		Variabile	9909230					
		Digitale						
CAMPANA FRIZIONE			9924940					
CINGHIA DI TRASMISSIONE		Top	9907770	9913280	9913280	9913280	9913280	
		Mitsuboshi	9935270	9935800	9935800	9935800	9935800	
CONVERTITORE DI COPPIA			9923030	9923030	9923030	9923030	9923030	
FRIZIONE CENTRIFUGA		Interno Ø 105	9911060					
		Interno Ø 107	9910020					
GRUPPO TERMICO		Ø Standard		9925650	9925650	9925650	9925650	
		Magg. c/testa		9924890	9924890	9924890	9924890	
		Magg. s/testa						
		Modifica da AC a LC	9911090					
GRUPPO TERMICO BLACK TROPHY		Ø Standard	9931140					
		Ø Maggiorato	9931340					
MOTORINO D'AVVIAMENTO			MA00001					
RAPPORTO ALLUNGATO		Primari	9913300					
		Secondari						
SCARICO POWERED 2		Omologato						
SCARICO HP 2		Omologato						9933310
VALVOLA LAMELLARE			9908370					
VARIOTOP		TPR c/cinghia	9931670					
		TPR s/cinghia	9931650	9924900	9924900	9924900	9924900	

Derbi	Derbi	Derbi	Derbi	Derbi	Derbi	Derbi	Derbi	Derbi	Derbi	Derbi
Atlantis 2T	Atlantis 2T EU2	Atlantis 4T	Atlantis 4T EU2	Atlantis O2	Atlantis O2 Bullet	Atlantis O2 City	Atlantis O2 Red Bullet	Atlantis O2 Two Chic	Boulevard	Boulevard 4T EU2 25KM/H
10-10	07-09	04-06	07-07	02-02	03-05	03-06	03-03	05-05	09-12	-
50cc 2T AC	50cc 2T AC	50cc 4T AC	50cc 4T AC	50cc 2T AC	50cc 2T AC	50cc 2T AC	50cc 2T AC	50cc 2T AC	50cc 2T AC	50cc 4T AC
Motore Piaggio	Motore Piaggio	Motore Piaggio	Motore Piaggio	Motore Piaggio	Motore Piaggio	Motore Piaggio	Motore Piaggio	Motore Piaggio	Motore Piaggio	Motore Piaggio
IM07060	IM07060			IM07060	IM07060	IM07060	IM07060	IM07060	IM07060	
IM07015	IM07015			IM07015	IM07015	IM07015	IM07015	IM07015	IM07015	
9924950	9924950			9924950	9924950	9924950	9924950	9924950	9924950	
9922030	9922030			9922030	9922030	9922030	9922030	9922030		
9935830	9935830			9935830	9935830	9935830	9935830	9935830		
9923150	9923150			9923150	9923150	9923150	9923150	9923150	9923150	
9910020	9910020			9910020	9910020	9910020	9910020	9910020	9910020	
9914500	9914500			9914500	9914500	9914500	9914500	9914500	9914500	
		9925150	9925150							9925150
9931250	9931250			9931250	9931250	9931250	9931250	9931250	9931250	
MA00002	MA00002	MA00015	MA00015	MA00002	MA00002	MA00002	MA00002	MA00002	MA00002	MA00015
9910930	9910930			9910930	9910930	9910930	9910930	9910930	9910930	
9931300	9931300			9931300	9931300	9931300	9931300	9931300		
9927610	9927610			9927610	9927610	9927610	9927610	9927610	9927610	

SCOOTER 50cc



Derbi	Derbi	Derbi	Derbi	Derbi	Derbi
GP1	GP1	GP1 EU2	GP1 Open EU2	GP1 Race EU2	Sonar 2T
01-02	03-03	05-05	06-09	05-07	09-09
50cc 2T LC	50cc 2T LC	50cc 2T LC	50cc 2T LC	50cc 2T LC	50cc 2T AC
Motore Piaggio	Motore Piaggio	Motore Piaggio	Motore Piaggio	Motore Piaggio	Motore Piaggio

ALBERO MOTORE		Con Cuscinetti e Paraoli	IM07060	IM07060	IM07060	IM07060	IM07060	IM07060
		Senza Cuscinetti e Paraoli	IM07015	IM07015	IM07015	IM07015	IM07015	IM07015
ACCENSIONE		Fissa						
		Variabile						
		Digitale						
CAMPANA FRIZIONE			9924950	9924950	9924950	9924950	9924950	9924950
CINGHIA DI TRASMISSIONE		Top	9922030	9922030	9922030	9922030	9922030	9922030
		Mitsuboshi	9935830	9935830	9935830	9935830	9935830	9935830
CONVERTITORE DI COPPIA			9923150	9923150	9923150	9923150	9923150	9923150
FRIZIONE CENTRIFUGA		Interno Ø 105						
		Interno Ø 107	9910020	9910020	9910020	9910020	9910020	9910020
GRUPPO TERMICO		Ø Standard	9916580	9916580	9916580	9916580	9916580	9914500
		Magg. c/testa						
		Magg. s/testa						
		Modifica da AC a LC						
GRUPPO TERMICO BLACK TROPHY		Ø Standard						
		Ø Maggiorato	9931270	9931270	9931270	9931270	9931270	9931250
MOTORINO D'AVVIAMENTO			MA00002	MA00002	MA00002	MA00002	MA00002	MA00002
RAPPORTO ALLUNGATO		Primari						
		Secondari						
SCARICO POWERED 2								
SCARICO HP 2								
VALVOLA LAMELLARE			9910930	9910930	9910930	9910930	9910930	9910930
VARIOTOP		TPR c/cinghia	9931300	9931300	9931300	9931300	9931300	9931300
		TPR s/cinghia	9927610	9927610	9927610	9927610	9927610	9927610

SCOOTER 50cc

Explorer	Garelli	Garelli	Garelli	Garelli	Garelli	Garelli	Garelli	Garelli	Garelli	Gilera
Cracker	Capri LX	Capri LX	Ciclone	Ciclone	Flexi	New Vip	Tiesse 2T	Tiesse 4T	Vip	DNA
03-03	06-07	08-08	06-07	08-08	08-11	06-07	08-08	08-10	06-06	00-02
50cc 2T AC	50cc 4T AC	50cc 4T AC	50cc 4T AC	50cc 4T AC	50cc 4T AC	50cc 4T AC	50cc 2T AC	50cc 4T AC	50cc 4T AC	50cc 2T LC
Tipo Keeway		Tipo Kymco		Tipo Kymco	Tipo Kymco			Tipo Kymco	Tipo Kymco	Motore Piaggio
										IM07060
										IM07015
										9924870
										9924880
										9924950
9913280							9913280		9913280	
9935800							9935800		9935800	
9923030										
										9910020
9925650										9916580
9924890										
	9925140	9925140	9925140	9925140	9925140	9925140		9925140	9925140	
										9931270
										MA00002
										9910930
9924900										9927610

SCOOTER 50cc



		Gilera	Gilera	Gilera	Gilera	Gilera	Gilera
		DNA	DNA GP Experience	Easy Moving	Ice	Ice Kat	Runner
		05-07	03-04	95-96	01-05	-	97-00
		50cc 2T LC	50cc 2T LC	50cc 2T AC	50cc 2T AC	50cc 2T AC	50cc 2T LC
		Motore Piaggio	Motore Piaggio	Motore Piaggio	Motore Piaggio		Motore Piaggio
ALBERO MOTORE		Con Cuscinetti e Paraoli	IM07060	IM07060	IM07060	IM07060	IM07060
		Senza Cuscinetti e Paraoli	IM07015	IM07015	IM07015	IM07015	IM07015
ACCENSIONE		Fissa	9924870	9924870	9924870	9924870	9924870
		Variabile	9924880	9924880	9924880	9924880	9924880
		Digitale					
CAMPANA FRIZIONE			9924950	9924950	9924950	9924950	9924950
CINGHIA DI TRASMISSIONE		Top			9913350	9922030	9922030
		Mitsuboshi			9935810	9935830	9935830
CONVERTITORE DI COPPIA				9923150	9923150		9923150
FRIZIONE CENTRIFUGA		Interno Ø 105					
		Interno Ø 107	9910020	9910020	9910020	9910020	9910020
GRUPPO TERMICO		Ø Standard	9916580	9916580	9914500	9914500	9916580
		Magg. c/testa					
		Magg. s/testa					
		Modifica da AC a LC					
GRUPPO TERMICO BLACK TROPHY		Ø Standard					
		Ø Maggiorato	9931270	9931270	9931250	9931250	9931270
MOTORINO D'AVVIAMENTO			MA00002	MA00002	MA00002	MA00002	MA00002
RAPPORTO ALLUNGATO		Primari					
		Secondari					
SCARICO POWERED 2						9932980	
SCARICO HP 2							
VALVOLA LAMELLARE			9910930	9910930	9910930	9910930	9910930
VARIOTOP		TPR c/cinghia				9931300	9931300
		TPR s/cinghia	9927610	9927610	9927610	9927610	9927610

Gilera	Gilera	Gilera	Gilera	Gilera	Gilera	Gilera	Gilera	Gilera	Gilera	Gilera
Runner Poggiali	Runner Pure Jet	Runner Pure Jet	Runner Pure Jet	Runner Pure Jet	Runner Pure Jet ST	Runner Purejet	Runner SP	Runner SP	Runner SP	Runner SP
02-02	02-04	05-06	07-07	10-11	08-08	-	02-04	05-06	07-07	10-12
50cc 2T LC	50cc 2T-IE LC	50cc 2T-IE LC	50cc 2T-IE LC	50cc 2T-IE LC	50cc 2T-IE LC	50cc 2T AC	50cc 2T LC	50cc 2T LC	50cc 2T LC	50cc 2T LC
Motore Piaggio	Motore Piaggio	Motore Piaggio	Motore Piaggio	Motore Piaggio	Motore Piaggio		Motore Piaggio	Motore Piaggio	Motore Piaggio	Motore Piaggio
IM07060							IM07060	IM07060	IM07060	IM07060
IM07015	IM07064	IM07064	IM07064	IM07064	IM07064		IM07015	IM07015	IM07015	IM07015
9924870							9924870	9924870	9924870	9924870
9924880							9924880	9924880	9924880	9924880
9924950	9924950	9924950	9924950	9924950	9924950		9924950	9924950	9924950	9924950
	9922030	9922030	9922030	9922030			9922030	9922030		
	9935830	9935830	9935830	9935830			9935830	9935830		
	9923150	9923150	9923150	9923150			9923150	9923150		
9910020							9910020	9910020	9910020	9910020
9916580	9916580	9916580	9916580	9916580	9916580		9916580	9916580	9916580	9916580
9931270	9931270	9931270	9931270	9931270	9931270		9931270	9931270	9931270	9931270
MA00002	MA00015	MA00015	MA00015	MA00015	MA00015		MA00002	MA00002	MA00002	MA00002
						9932990				
9910930	9910930	9910930	9910930	9910930	9910930		9910930	9910930	9910930	9910930
	9931300	9931300	9931300	9931300			9931300			
9927610	9927610	9927610	9927610	9927610			9927610	9927610	9927610	9927610

SCOOTER 50cc



		Gilera	Gilera	Gilera	Gilera	Gilera	Gilera
		Runner SP ST & Simoncelli	Runner SP Special Edition	Runner Sp	Stalker	Stalker	Stalker
		08-09	07-07	-	97-04	05-06	07-08
		50cc 2T LC	50cc 2T LC	50cc 2T AC	50cc 2T AC	50cc 2T AC	50cc 2T AC
		Motore Piaggio	Motore Piaggio		Motore Piaggio	Motore Piaggio	Motore Piaggio
ALBERO MOTORE		Con Cuscinetti e Paraoli	IM07060	IM07060		IM07060	IM07060
		Senza Cuscinetti e Paraoli	IM07015	IM07015		IM07015	IM07015
ACCENSIONE		Fissa	9924870	9924870		9924870	9924870
		Variabile	9924880	9924880		9924880	9924880
		Digitale					
CAMPANA FRIZIONE			9924950	9924950		9924950	9924950
CINGHIA DI TRASMISSIONE		Top				9922030	9922030
		Mitsuboshi				9935830	9935830
CONVERTITORE DI COPPIA						9923150	9923150
FRIZIONE CENTRIFUGA		Interno Ø 105					
		Interno Ø 107	9910020	9910020		9910020	9910020
GRUPPO TERMICO		Ø Standard	9916580	9916580		9914500	9914500
		Magg. c/testa					
		Magg. s/testa					
		Modifica da AC a LC					
GRUPPO TERMICO BLACK TROPHY		Ø Standard					
		Ø Maggiorato	9931270	9931270		9931250	9931250
MOTORINO D'AVVIAMENTO			MA00002	MA00002		MA00002	MA00002
RAPPORTO ALLUNGATO		Primari					
		Secondari					
SCARICO POWERED 2		Omologato					
SCARICO HP 2		Omologato			9933300		
VALVOLA LAMELLARE			9910930	9910930		9910930	9910930
VARIOTOP		TPR c/cinghia				9931300	9931300
		TPR s/cinghia	9927610	9927610		9927610	9927610

SCOOTER 50cc

Gilera	Gilera	Gilera	Gilera	Gilera	Gilera	Gilera	Gilera	Gilera	Gilera	Gilera
Stalker	Stalker Naked	Stalker Special Edition	Storm	Storm	Storm Euro 2	Typhoon	Typhoon	Typhoon	Typhoon X	Typhoon XR
09-11	08-08	07-08	94-95	-	07-07	94-97	-	-	98-99	00-00
50cc 2T AC	50cc 2T AC	50cc 2T AC	50cc 2T AC	50cc 2T AC	50cc 2T AC	50cc 2T AC	50cc 2T AC	50cc 2T AC	50cc 2T AC	50cc 2T AC
Motore Piaggio	Motore Piaggio	Motore Piaggio	Motore Piaggio		Motore Piaggio	Motore Piaggio			Motore Piaggio	Motore Piaggio
IM07060	IM07060	IM07060	IM07060		IM07060	IM07060			IM07060	IM07060
IM07015	IM07015	IM07015	IM07015		IM07015	IM07015			IM07015	IM07015
9924870	9924870	9924870	9924870			9924870			9924870	9924870
9924880	9924880	9924880	9924880			9924880			9924880	9924880
9924950	9924950	9924950	9924950		9924950	9924950			9924950	9924950
9922030	9922030	9922030	9913280		9922030	9913280			9913280	9922030
9935830	9935830	9935830	9935800		9935830	9935800			9935800	9935830
9923150	9923150	9923150	9923150		9923150	9923150			9923150	9923150
9910020	9910020	9910020	9910020		9910020	9910020			9910020	
9914500	9914500	9914500	9914500		9914500	9914500			9914500	9914500
9931250	9931250	9931250	9931250		9931250	9931250			9931250	9931250
MA00002	MA00002	MA00002	MA00002		MA00002	MA00002			MA00002	MA00002
					9932920			9932920	9932920	
					9933330			9933330	9933330	
9910930	9910930	9910930	9910930		9910930	9910930			9910930	9910930
9931300	9931300	9931300			9931300					9931300
9927610	9927610	9927610	9927610		9927610	9927610			9927610	9927610

SCOOTER 50cc



HSC	HSC	Honda	Honda	Honda	Honda
SC 01	SC 01 L	Bali	Dio SR	Dio ZX	Lead
-00	-00	93-99	92-00	-00	89-90
50cc 2T AC	50cc 2T AC	50cc 2T AC	50cc 2T AC	50cc 2T AC	50cc 2T AC
Motore Honda		Motore Honda	Motore Honda	Motore Honda	Motore Honda

ALBERO MOTORE		Con Cuscinetti e Paraoli						
		Senza Cuscinetti e Paraoli						
ACCENSIONE		Fissa						
		Variabile						
		Digitale						
CAMPANA FRIZIONE								
CINGHIA DI TRASMISSIONE		Top						
		Mitsuboshi			9935240			
CONVERTITORE DI COPPIA								
FRIZIONE CENTRIFUGA		Interno Ø 105						
		Interno Ø 107	9910020	9910020	9910020		9910020	
GRUPPO TERMICO		Ø Standard						
		Magg. c/testa						
		Magg. s/testa						
		Modifica da AC a LC						
GRUPPO TERMICO BLACK TROPHY		Ø Standard						
		Ø Maggiorato						
MOTORINO D'AVVIAMENTO								
RAPPORTO ALLUNGATO		Primari						
		Secondari						
SCARICO POWERED 2		Omologato						
SCARICO HP 2		Omologato						
VALVOLA LAMELLARE			9912550	9912550	9912550	9912550	9912550	9912550
VARIOTOP		TPR c/cinghia						
		TPR s/cinghia						

SCOOTER 50cc



Italjet	Italjet	Italjet	Italjet	Italjet	Italjet
Bazooka	Dragster	Jet Set	Pista	Pista 2	Scoop
-00	-00	-00	-00	-00	-00
50cc 2T AC	50cc 2T LC	50cc 2T AC	50cc 2T AC	50cc 2T AC	50cc 2T AC
Tipo CW	MA	Motore Piaggio	Tipo CW	Tipo CW	Tipo CW

ALBERO MOTORE		Con Cuscinetti e Paraoli		IM07059	IM07060			
		Senza Cuscinetti e Paraoli		IM07014	IM07015			
ACCENSIONE		Fissa		9910100	9924870			
		Variabile		9909230	9924880			
		Digitale						
CAMPANA FRIZIONE				9924940	9924950			
CINGHIA DI TRASMISSIONE		Top		9907770	9922030		9907770	
		Mitsuboshi		9935270	9935830		9935270	
CONVERTITORE DI COPPIA				9923030	9923150			
FRIZIONE CENTRIFUGA		Interno Ø 105	9911060	9911060		9911060	9911060	9911060
		Interno Ø 107	9910020	9910020	9910020	9910020	9910020	9910020
GRUPPO TERMICO		Ø Standard			9914500			
		Magg. c/testa						
		Magg. s/testa						
		Modifica da AC a LC						
GRUPPO TERMICO BLACK TROPHY		Ø Standard		9931110				
		Ø Maggiorato		9931310	9931250			
MOTORINO D'AVVIAMENTO				MA00001				
RAPPORTO ALLUNGATO		Primari		9913300				
		Secondari		9909520				
SCARICO POWERED 2		Omologato						
SCARICO HP 2		Omologato						
VALVOLA LAMELLARE				9908370	9910930			
VARIOTOP		TPR c/cinghia		9931670				
		TPR s/cinghia		9931650	9927610			

SCOOTER 50cc

Italjet	Italjet	Italjet	Italjet	KTM	Keeway	Keeway	Keeway	Keeway	Keeway	Keeway
Scoop 2	Torpedo	Torpedo New	Yankee	K50	F-Act	Flash	Focus	Goccia	Hurricane	Matrix
-00	-00	-00	-00	-00	07-08	07-08	06-06	09-09	06-08	06-08
50cc 2T AC	50cc 4T AC	50cc 2T AC	50cc 2T AC	50cc 2T AC	50cc 2T AC	50cc 2T AC	50cc 2T AC	50cc 2T AC	50cc 2T AC	50cc 2T AC
Tipo CW	Motore Piaggio	Motore Piaggio	Tipo CW	MY	Motore Keeway	Motore Keeway	Motore Keeway	Motore Keeway	Motore Keeway	Motore Keeway
		IM07060		IM07059						
		IM07015		IM07014						
		9924870								
		9924880		9909300						
		9924950		9924940						
9907770		9922030	9907770	9907770	9913280	9913280	9913280	9913280	9913280	9913280
9935270		9935830	9935270	9935270	9935800	9935800	9935800	9935800	9935800	9935800
		9923150		9923030	9923030	9923030	9923030	9923030	9923030	9923030
9911060			9911060	9911060						
9910020		9910020	9910020	9910020						
		9914500			9925650	9925650	9925650	9925650	9925650	9925650
					9924890	9924890	9924890	9924890	9924890	9924890
	9925150									
				9911090						
				9931140						
		9931250		9931340						
				MA00001						
				9913300						
		9910930		9908370						
				9931670						
		9927610		9931650	9924900	9924900	9924900	9924900	9924900	9924900

SCOOTER 50cc



Keeway	Keeway	Kymco	Kymco	Kymco	Kymco
Pixel Euro 2	RY8	Agility 4T Carry	Agility 4T R10	Agility 4T R10	Agility 4T R12
-00	08-08	11-11	06-06	07-08	07-08
50cc 2T AC	50cc 2T AC	50cc 4T AC	50cc 4T AC	50cc 4T AC	50cc 4T AC
Motore Keeway	Motore Keeway	Motore Kymco	Motore Kymco	Motore Kymco	Motore Kymco

ALBERO MOTORE		Con Cuscinetti e Paraoli						
		Senza Cuscinetti e Paraoli						
ACCENSIONE		Fissa						
		Variabile						
		Digitale						
CAMPANA FRIZIONE								
CINGHIA DI TRASMISSIONE		Top	9913280	9913280	9931590			9931590
		Mitsuboshi	9935800	9935800				
CONVERTITORE DI COPPIA			9923030	9923030				
FRIZIONE CENTRIFUGA		Interno Ø 105						
		Interno Ø 107						
GRUPPO TERMICO		Ø Standard	9925650	9925650				
		Magg. c/testa	9924890	9924890				
		Magg. s/testa			9925140	9925140	9925140	9925140
		Modifica da AC a LC						
GRUPPO TERMICO BLACK TROPHY		Ø Standard						
		Ø Maggiorato						
MOTORINO D'AVVIAMENTO				MA00025	MA00025	MA00025	MA00025	
RAPPORTO ALLUNGATO		Primari						
		Secondari						
SCARICO POWERED 2		Omologato						
SCARICO HP 2		Omologato						
VALVOLA LAMELLARE								
VARIOTOP		TPR c/cinghia						
		TPR s/cinghia	9924900	9924900				

SCOOTER 50cc

Kymco	Kymco	Kymco	Kymco	Kymco	Kymco	Kymco	Kymco	Kymco	Kymco	Kymco
Agility R12	Agility R16	Agility R16	Agility R16	Agility R16	Agility R16 2T	Agility R16 2T	Agility RS	Agility RS Naked	Bet & Win	Bet & Win EU2
05-05	08-08	09-09	12-12	-	10-10	12-12	09-09	10-10	02-02	03-03
50cc 4T AC	50cc 4T AC	50cc 4T AC	50cc 4T AC	50cc 2T AC	50cc 2T AC	50cc 2T AC	50cc 4T AC	50cc 2T AC	50cc 2T LC	50cc 2T LC
Motore Kymco	Motore Kymco	Motore Kymco	Motore Kymco		Motore Kymco	Motore Kymco	Motore Kymco	Motore Kymco	Motore Kymco	Motore Kymco
9931590	9931590	9931590	9931590		9931590	9931590	9931590	9931590	9931590	9931590
9910020										
9925140	9925140	9925140	9925140				9925140			
MA00025	MA00025	MA00025	MA00025				MA00025		MA00014	MA00014
				9932900						

SCOOTER 50cc



Kymco	Kymco	Kymco	Kymco	Kymco	Kymco
Bet&Win	CX	CX Super	DJ World	DJY	Dink
-	93-93	94-97	94-00	93-93	-
50cc 2T AC	50cc 2T AC	50cc 2T AC	50cc 2T AC	50cc 2T AC	50cc 2T AC
Motore Kymco Motore Kymco Motore Kymco Motore Kymco					

ALBERO MOTORE		Con Cuscinetti e Paraoli Senza Cuscinetti e Paraoli					
ACCENSIONE		Fissa Variabile Digitale					
CAMPANA FRIZIONE							
CINGHIA DI TRASMISSIONE		Top Mitsuboshi					
CONVERTITORE DI COPPIA							
FRIZIONE CENTRIFUGA		Interno Ø 105 Interno Ø 107					
GRUPPO TERMICO		Ø Standard Magg. c/testa Magg. s/testa Modifica da AC a LC					
GRUPPO TERMICO BLACK TROPHY		Ø Standard Ø Maggiorato					
MOTORINO D'AVVIAMENTO							
RAPPORTO ALLUNGATO		Primari Secondari					
SCARICO POWERED 2		Omologato	9932900				9932900
SCARICO HP 2		Omologato					
VALVOLA LAMELLARE				9912550	9912550	9912550	9912550
VARIOTOP		TPR c/cinghia TPR s/cinghia					

SCOOTER 50cc



Kymco	Kymco	Kymco	Kymco	Kymco	Kymco
Like	Like	People	People	People Eco Kat	People Euro 2
09-09	09-09	99-03	04-04	-	03-03
50cc 4T AC	50cc 2T AC	50cc 2T AC	50cc 2T AC	50cc 2T AC	50cc 2T AC
Motore Kymco			Motore Kymco		Motore Kymco

ALBERO MOTORE		Con Cuscinetti e Paraoli					
		Senza Cuscinetti e Paraoli					
ACCENSIONE		Fissa					
		Variabile					
		Digitale					
CAMPANA FRIZIONE							
CINGHIA DI TRASMISSIONE		Top	9931590	9931590	9931590	9931590	9931590
		Mitsuboshi					
CONVERTITORE DI COPPIA							
FRIZIONE CENTRIFUGA		Interno Ø 105					
		Interno Ø 107					
GRUPPO TERMICO		Ø Standard					
		Magg. c/testa					
		Magg. s/testa	9925140	9925140			
		Modifica da AC a LC					
GRUPPO TERMICO BLACK TROPHY		Ø Standard					
		Ø Maggiorato					
MOTORINO D'AVVIAMENTO			MA00025		MA00014	MA00014	MA00014
RAPPORTO ALLUNGATO		Primari					
		Secondari					
SCARICO POWERED 2		Omologato				9932900	
SCARICO HP 2		Omologato					
VALVOLA LAMELLARE							
VARIOTOP		TPR c/cinghia					
		TPR s/cinghia					

SCOOTER 50cc



Kymco	Kymco	Kymco	Kymco	Kymco	Kymco
Super 9	Super 9	Super 9 EU2	Super 9 EU2	Top Boy	Top Boy On/Off
00-00	-	03-03	04-04	97-00	-
50cc 2T LC	50cc 2T AC	50cc 2T LC	50cc 2T LC	50cc 2T AC	50cc 2T AC
Motore Kymco		Motore Kymco	Motore Kymco	Motore Kymco	

ALBERO MOTORE		Con Cuscinetti e Paraoli					
		Senza Cuscinetti e Paraoli					
ACCENSIONE		Fissa					
		Variabile					
		Digitale					
CAMPANA FRIZIONE							
CINGHIA DI TRASMISSIONE		Top	9931590		9931590		9931590
		Mitsuboshi					
CONVERTITORE DI COPPIA							
FRIZIONE CENTRIFUGA		Interno Ø 105					
		Interno Ø 107					
GRUPPO TERMICO		Ø Standard					
		Magg. c/testa					
		Magg. s/testa					
		Modifica da AC a LC					
GRUPPO TERMICO BLACK TROPHY		Ø Standard					
		Ø Maggiorato					
MOTORINO D'AVVIAMENTO			MA00014		MA00014		MA00014
RAPPORTO ALLUNGATO		Primari					
		Secondari					
SCARICO POWERED 2		Omologato		9932900			9932900
SCARICO HP 2		Omologato					
VALVOLA LAMELLARE							
VARIOTOP		TPR c/cinghia					
		TPR s/cinghia					

SCOOTER 50cc

Kymco	Kymco	Kymco	Kymco	Kymco	Kymco	Macal	Macal	Malaguti	Malaguti	Malaguti
Vitality	Vitality 2T	Vitality 4T	Yup	Yup	Yup EU2	Sting	Thunder	Centro	Centro Euro 2	Centro SL 4T
-	04-04	04-04	02-02	-	03-03	-00	-00	-00	08-08	10-10
50cc 2T AC	50cc 2T AC	50cc 4T AC	50cc 2T AC	50cc 2T AC	50cc 2T AC	50cc 2T AC	50cc 2T AC	50cc 2T AC	50cc 4T AC	50cc 4T AC
	Motore Kymco	Motore Kymco	Motore Kymco		Motore Kymco	CY	MY	MY	Motore Piaggio	Motore Piaggio
							IM07059	IM07059		
							IM07014	IM07014		
						9909300	9909300	9909300		
							9924940	9924940		
	9931590	9931590	9931590		9931590		9907770	9907770		
							9935270	9935270		
							9923030	9923030		
							9911060	9911060		
							9910020	9910020		
		9925140							9925150	9925150
							9911090	9911090		
							9931140	9931140		
							9931340	9931340		
	MA00014		MA00014		MA00014	MA00001	MA00001	MA00001	MA00015	MA00015
						9913310	9913300	9913300		
9932900				9932900						
							9908370	9908370		
							9931670	9931670		
							9931650	9931650		

SCOOTER 50cc



Malaguti	Malaguti	Malaguti	Malaguti	Malaguti	Malaguti
Ciak	Ciak Euro 2 2,3	Ciak Euro2	Ciak Master 4T	Ciak Master Euro 2	Ciak Master Euro 2
-00	03-03	01-03	05-06	05-06	06-06
50cc 2T AC	50cc 2T AC	50cc 2T AC	50cc 4T AC	50cc 4T AC	50cc 2T AC
MY	MY	MY	Motore Piaggio	Motore Piaggio	MY

ALBERO MOTORE		Con Cuscinetti e Paraoli	IM07059	IM07059	IM07059			IM07059
		Senza Cuscinetti e Paraoli	IM07014	IM07014	IM07014			IM07014
ACCENSIONE		Fissa						
		Variabile	9909300		9909300			
		Digitale		9921210				9925780
CAMPANA FRIZIONE			9924940	9924940	9924940			9924940
CINGHIA DI TRASMISSIONE		Top	9907770	9907770	9907770			9907770
		Mitsuboshi	9935270	9935270	9935270			9935270
CONVERTITORE DI COPPIA			9923030	9923030	9923030			9923030
FRIZIONE CENTRIFUGA		Interno Ø 105	9911060	9911060	9911060			
		Interno Ø 107	9910020	9910020	9910020			
GRUPPO TERMICO		Ø Standard						
		Magg. c/testa						
		Magg. s/testa				9925150	9925150	
		Modifica da AC a LC	9911090	9911090	9911090			9911090
GRUPPO TERMICO BLACK TROPHY		Ø Standard	9931140	9931140	9931140			9931140
		Ø Maggiorato	9931340	9931340	9931340			9931340
MOTORINO D'AVVIAMENTO			MA00001	MA00001	MA00001	MA00015		MA00001
RAPPORTO ALLUNGATO		Primari	9913300	9913300	9913300			9913300
		Secondari						
SCARICO POWERED 2								
SCARICO HP 2								
VALVOLA LAMELLARE			9908370	9908370	9908370			9908370
VARIOTOP		TPR c/cinghia	9931670	9931670	9931670			9931670
		TPR s/cinghia	9931650	9931650	9931650			9931650

Malaguti	Malaguti	Malaguti	Malaguti	Malaguti	Malaguti	Malaguti	Malaguti	Malaguti	Malaguti	Malaguti
DVD	F10	F10 Euro 2	F10 Euro 2 2,3	F10 Restyling Euro 2	F10 Wap Euro 2	F12 Phantom	F12 Phantom Euro 2	F12 Phantom Euro 2 2,3	F12 Phantom LC	F12 Phantom LC Euro 2 2,3
10-10	-00	-00	03-04	06-06	-00	-00	02-02	03-04	-00	03-04
50cc 4T AC	50cc 2T AC	50cc 2T AC	50cc 2T AC	50cc 2T AC	50cc 2T AC	50cc 2T AC	50cc 2T LC	50cc 2T AC	50cc 2T LC	50cc 2T LC
Tipo Kymco	CY	CY	CY	CY	Tipo Keeway	MY	MA vent.	MY	MA	MA vent.
	IM07059	IM07059	IM07059	IM07059		IM07059			IM07059	
	IM07014	IM07014	IM07014	IM07014		IM07014	IM07018	IM07018	IM07014	IM07018
	9909300	9909300				9909300			9909300	
			9921210	9925780				9921210		9921210
	9924940	9924940	9924940	9924940		9924940		9924940	9924940	
	9907900	9907900	9907900	9907900	9913280	9907770	9907770	9907770	9907770	9907770
	9935340	9935340	9935340	9935340	9935800	9935270	9935270	9935270	9935270	9935270
	9923030	9923030	9923030	9923030	9923030	9923030	9923030	9923030	9923030	9923030
	9911060	9911060	9911060			9911060		9911060	9911060	9911060
	9910020	9910020	9910020			9910020	9910020	9910020	9910020	9910020
					9925650					
					9924890					
9925140										
	9911090	9911090	9911090	9911090		9911090		9911090		
	9931140	9931140	9931140	9931140		9931140	9931110	9931140	9931110	9931110
	9931340	9931340	9931340	9931340		9931340	9931310	9931340	9931310	9931310
	MA00001	MA00001	MA00001	MA00001		MA00001	MA00001	MA00001	MA00001	MA00001
	9913310	9913310	9913310	9913310		9913300		9913300	9913300	
						9909520		9909520	9909520	
	9908370	9908370	9908370	9908370		9908370	9908370	9908370	9908370	9908370
	9931690	9931690	9931690	9931690		9931670	9931670	9931670	9931670	9931670
	9931650	9931650	9931650	9931650	9924900	9931650	9931650	9931650	9931650	9931650

SCOOTER 50cc



Malaguti	Malaguti	Malaguti	Malaguti	Malaguti	Malaguti
F12 R Phantom	F12 R Phantom LC	F12 Restyling Euro 1	F12 Restyling Euro 2	F12 Restyling LC Euro 2	F15 Firefox
07-07	07-09	99-02	06-06	06-06	-00
50cc 2T AC	50cc 2T LC	50cc 2T LC	50cc 2T AC	50cc 2T LC	50cc 2T LC
Tipo Keeway	MA	MA vent.	MY	MA vent.	MA

ALBERO MOTORE		Con Cuscinetti e Paraoli		IM07059					IM07059
		Senza Cuscinetti e Paraoli		IM07014	IM07018	IM07018	IM07018	IM07018	IM07014
ACCENSIONE		Fissa							
		Variabile			9909300				9909300
		Digitale		9925780		9925780	9925780		
CAMPANA FRIZIONE				9924940		9924940			9924940
CINGHIA DI TRASMISSIONE		Ø Standard	9913280	9907770	9907770	9907770	9907770	9907770	9907770
		Ø Maggiorato	9935800	9935270	9935270	9935270	9935270	9935270	9935270
CONVERTITORE DI COPPIA			9923030	9923030	9923030	9923030	9923030	9923030	9923030
FRIZIONE CENTRIFUGA		Interno Ø 105				9911060			9911060
		Interno Ø 107			9910020	9910020			9910020
GRUPPO TERMICO		Ø Standard	9925650						
		Magg. c/testa	9924890						
		Magg. s/testa							
		Modifica da AC a LC				9911090			
GRUPPO TERMICO BLACK TROPHY		Ø Standard		9931110	9931110	9931140	9931110	9931110	9931110
		Ø Maggiorato		9931310	9931310	9931340	9931310	9931310	9931310
MOTORINO D'AVVIAMENTO				MA00001	MA00001	MA00001	MA00001	MA00001	MA00001
RAPPORTO ALLUNGATO		Primari		9913300		9913300			9913300
		Secondari		9909520		9909520			9909520
SCARICO POWERED 2		Omologato							
SCARICO HP 2		Omologato							
VALVOLA LAMELLARE				9908370	9908370	9908370	9908370	9908370	9908370
VARIOTOP		TPR c/cinghia		9931670	9931670	9931670	9931670	9931670	9931670
		TPR s/cinghia	9924900	9931650	9931650	9931650	9931650	9931650	9931650

Malaguti	Malaguti	Malaguti	Malaguti	Malaguti	Malaguti	Malaguti	Malaguti	Malaguti	Malaguti	Malaguti
F15 Firefox	F15 Firefox	F15 Firefox Euro 2	F15 Firefox Euro 2	F15 Firefox Euro 2	F15 Firefox Euro 2,3	F12 Phantom	F12 Phantom	F12 Phantom Kat	F12 Phantom Kat	Yesterday
-	-	02-03	04-06	05-06	03-04	-	-	-	-	97-00
50cc 2T AC	50cc 2T AC	50cc 2T LC	50cc 2T LC	50cc 2T AC	50cc 2T LC	50cc 2T AC	50cc 2T AC	50cc 2T AC	50cc 2T AC	50cc 2T AC
		MA	MA	MY	MA					CY
		IM07059	IM07059	IM07059	IM07059					IM07059
		IM07014	IM07014	IM07014	IM07014					IM07014
										9909300
			9925780	9925780	9921210					
		9924940	9924940	9924940	9924940					9924940
		9907770	9907770	9907770	9907770					9907900
		9935270	9935270	9935270	9935270					9935340
		9923030	9923030	9923030	9923030					9923030
		9911060			9911060					9911060
		9910020			9910020					9910020
				9911090						9911090
		9931110	9931110	9931140	9931110					9931140
		9931310	9931310	9931340	9931310					9931340
		MA00001	MA00001	MA00001	MA00001					MA00001
		9913300	9913300	9913300	9913300					9913310
		9909520	9909520	9909520	9909520					
9932960										
	9933380					9933320	9933320	9933320	9933320	
		9908370	9908370	9908370	9908370					9908370
		9931670	9931670	9931670	9931670					9931690
		9931650	9931650	9931650	9931650					9931650

SCOOTER 50cc



Mbk	Mbk	Mbk	Mbk	Mbk	Mbk
Booster	Booster	Booster Euro 2	Booster Kat	Booster NG	Booster NG
-00	-	04-04	-	03-03	-00
50cc 2T AC	50cc 2T AC	50cc 2T AC	50cc 2T AC	50cc 2T AC	50cc 2T AC
CW		CW		CW	CW

ALBERO MOTORE		Con Cuscinetti e Paraoli	IM07058		IM07058		IM07058	IM07058
		Senza Cuscinetti e Paraoli	IM07013		IM07013		IM07013	IM07013
ACCENSIONE		Fissa	9910100					9910100
		Variabile	9909230					9909230
		Digitale			9921790		9921790	
CAMPANA FRIZIONE								
CINGHIA DI TRASMISSIONE		Top	9907770		9907770		9907770	9907770
		Mitsuboshi	9935270		9935270		9935270	9935270
CONVERTITORE DI COPPIA			9923030		9923030		9923030	9923030
FRIZIONE CENTRIFUGA		Interno Ø 105	9911060		9911060		9911060	9911060
		Interno Ø 107	9910020		9910020		9910020	9910020
GRUPPO TERMICO		Ø Standard						
		Magg. c/testa						
		Magg. s/testa						
		Modifica da AC a LC						
GRUPPO TERMICO BLACK TROPHY		Ø Standard	9931170		9931170		9931170	9931170
		Ø Maggiorato	9931370		9931370		9931370	9931370
MOTORINO D'AVVIAMENTO			MA00001		MA00001		MA00001	MA00001
RAPPORTO ALLUNGATO		Primari	9913300		9913300		9913300	9913300
		Secondari					9909520	9909520
SCARICO POWERED 2		Omologato		9932950				
SCARICO HP 2		Omologato		9933370		9933370		
VALVOLA LAMELLARE			9906520		9906520		9906520	9906520
VARIOTOP		TPR c/cinghia	9931670		9931670		9931670	9931670
		TPR s/cinghia	9931650		9931650		9931650	9931650

SCOOTER 50cc

Mbk	Mbk	Mbk	Mbk	Mbk	Mbk	Mbk	Mbk	Mbk	Mbk	Mbk
Booster Next Generation	Booster Next Generation	Booster Next Generation Kat	Booster Rocket	Booster Spirit	Booster Spirit	Booster Track	Booster X ie	Evolis	Fizz	Flipper
-	-	-	97-98	03-03	-00	96-98	08-08	92-95	94-95	-00
50cc 2T AC	50cc 2T AC	50cc 2T AC	50cc 2T AC	50cc 2T AC	50cc 2T AC	50cc 2T AC	50cc 4T-3V LC	50cc 2T AC	50cc 2T AC	50cc 2T AC
			CW	CW	CW	CW	15P1	CY	CY	MY
			IM07058	IM07058	IM07058	IM07058		IM07059	IM07059	IM07059
			IM07013	IM07013	IM07013	IM07013		IM07014	IM07014	IM07014
			9910100		9910100	9910100		9910100	9910100	9910100
			9909230		9909230	9909230		9909230	9909230	9909230
				9921790						
								9924940	9924940	9924940
			9907770	9907770	9907770	9907770		9907900	9907900	9907770
			9935270	9935270	9935270	9935270		9935340	9935340	9935270
			9923030	9923030	9923030	9923030		9923030	9923030	9923030
			9911060	9911060	9911060	9911060				9911060
			9910020	9910020	9910020	9910020				9910020
								9911090	9911090	9911090
			9931170	9931170	9931170	9931170		9931140	9931140	9931140
			9931370	9931370	9931370	9931370		9931340	9931340	9931340
			MA00001	MA00001	MA00001	MA00001		MA00001	MA00001	MA00001
			9913300	9913300	9913300	9913300		9913310	9913310	9913300
9932950		9932900								
	9933370	9933370								
			9906520	9906520	9906520	9906520		9908370	9908370	9908370
			9931670	9931670	9931670	9931670		9931690	9931690	9931670
			9931650	9931650	9931650	9931650	9926130	9931650	9931650	9931650

SCOOTER 50cc



Mbk	Mbk	Mbk	Mbk	Mbk	Mbk
Flipper Euro 2	Forte	Mach G	Mach G LC	Nitro	Nitro
03-03	94-96	02-04	02-04	-00	-
50cc 2T AC	50cc 2T AC	50cc 2T AC	50cc 2T LC	50cc 2T LC	50cc 2T AC
MY	CY	MY	MA	MA	

ALBERO MOTORE		Con Cuscinetti e Paraoli	IM07059	IM07059	IM07059	IM07059	IM07059	
		Senza Cuscinetti e Paraoli	IM07014	IM07014	IM07014	IM07014	IM07014	
ACCENSIONE		Fissa					9910100	
		Variabile					9909230	
		Digitale	9921790		9921790	9921790		
CAMPANA FRIZIONE			9924940	9924940	9924940	9924940	9924940	
CINGHIA DI TRASMISSIONE		Top	9907770	9907900	9907770	9907770	9907770	
		Mitsuboshi	9935270	9935340	9935270	9935270	9935270	
CONVERTITORE DI COPPIA			9923030	9923030	9923030	9923030	9923030	
FRIZIONE CENTRIFUGA		Interno Ø 105	9911060		9911060	9911060	9911060	
		Interno Ø 107	9910020		9910020	9910020	9910020	
GRUPPO TERMICO		Ø Standard						
		Magg. c/testa						
		Magg. s/testa						
		Modifica da AC a LC	9911090	9911090	9911090			
GRUPPO TERMICO BLACK TROPHY		Ø Standard	9931140	9931140	9931140	9931110	9931110	
		Ø Maggiorato	9931340	9931340	9931340	9931310	9931310	
MOTORINO D'AVVIAMENTO			MA00001	MA00001	MA00001	MA00001	MA00001	
RAPPORTO ALLUNGATO		Primari	9913300	9913310	9913300	9913300	9913300	
		Secondari				9909520	9909520	
SCARICO POWERED 2		Omologato						9932960
SCARICO HP 2		Omologato						9933360
VALVOLA LAMELLARE			9908370	9908370	9908370	9908370	9908370	
VARIOTOP		TPR c/cinghia	9931670	9931690	9931670	9931670	9931670	
		TPR s/cinghia	9931650	9931650	9931650	9931650	9931650	

Mbk	Mbk	Mbk	Mbk	Mbk	Mbk	Mbk	Mbk	Mbk	Mbk	Mbk
Nitro Euro 2	Nitro Kat	Ovetto	Ovetto	Ovetto 4T	Ovetto Euro 2	Rocket	Rocket	Sorriso	Spirit	Spirit Kat
03-03	-	-00	-	09-11	02-02	-	-	95-96	-	-
50cc 2T LC	50cc 2T AC	50cc 2T AC	50cc 2T AC	50cc 4T-3V LC	50cc 2T AC	50cc 2T AC	50cc 2T AC	50cc 2T AC	50cc 2T AC	50cc 2T AC
MA		MY		5C3	MY			Tipo CW		
IM07059		IM07059			IM07059					
IM07014		IM07014			IM07014					
		9910100								
		9909230								
9921790					9921790					
9924940		9924940			9924940					
9907770		9907770			9907770					
9935270		9935270			9935270					
9923030		9923030			9923030					
9911060		9911060			9911060			9911060		
9910020		9910020			9910020			9910020		
		9911090			9911090					
9931110		9931140			9931140					
9931310		9931340			9931340					
MA00001		MA00001			MA00001					
9913300		9913300			9913300					
9909520										
			9932940			9932950				
	9933380						9933370		9933370	9933370
9908370		9908370			9908370					
9931670		9931670			9931670					
9931650		9931650		9926130	9931650					

SCOOTER 50cc



Mbk	Mbk	Mbk	Mbk	Motron	Motron
Stunt	Stunt	Stunt	Target	Sting	Syncro
00-02	-	-	91-95	-00	-00
50cc 2T AC	50cc 2T AC	50cc 2T AC	50cc 2T AC	50cc 2T AC	50cc 2T AC
CW			Tipo CW	CY	MY

ALBERO MOTORE		Con Cuscinetti e Paraoli	IM07058				IM07059
		Senza Cuscinetti e Paraoli	IM07013				IM07014
ACCENSIONE		Fissa	9910100				
		Variabile	9909230			9909300	9909300
		Digitale					
CAMPANA FRIZIONE							9924940
CINGHIA DI TRASMISSIONE		Top	9907770				9907770
		Mitsuboshi	9935270				9935270
CONVERTITORE DI COPPIA			9923030				9923030
FRIZIONE CENTRIFUGA		Interno Ø 105	9911060		9911060		9911060
		Interno Ø 107	9910020		9910020		9910020
GRUPPO TERMICO		Ø Standard					
		Magg. c/testa					
		Magg. s/testa					
		Modifica da AC a LC					9911090
GRUPPO TERMICO BLACK TROPHY		Ø Standard	9931170				9931140
		Ø Maggiorato	9931370				9931340
MOTORINO D'AVVIAMENTO			MA00001			MA00001	MA00001
RAPPORTO ALLUNGATO		Primari	9913300			9913310	9913300
		Secondari	9909520				
SCARICO POWERED 2		Omologato		9932950			
SCARICO HP 2		Omologato			9933370		
VALVOLA LAMELLARE			9906520				9908370
VARIOTOP		TPR c/cinghia	9931670				9931670
		TPR s/cinghia	9931650				9931650

SCOOTER 50cc

Motron	PGO	Peugeot	Peugeot	Peugeot	Peugeot	Peugeot	Peugeot	Peugeot	Peugeot	Peugeot
Thunder	Big Max	Buxi M	Buxy	Buxy RS	Elyseo	E-Vivacity (EC-45 km/h)	Jet Force	Kisbee	Looxor	Ludix
-00	-00	-	-00	-00	-00		-00	-00	-00	-00
50cc 2T AC	50cc 2T AC	50cc 2T AC	50cc 2T AC	50cc 2T AC	50cc 2T AC	50cc 2T AC	50cc 2T LC	50cc 2T AC	50cc 2T AC	50cc 2T AC
MY	Tipo MY		Motore Peugeot	Motore Peugeot	Motore Peugeot	Motore Peugeot	Motore Peugeot	Motore Peugeot	Motore Peugeot	Motore Peugeot
IM07059			IM07061	IM07061	IM07061				IM07061	
IM07014			IM07016	IM07016	IM07016				IM07016	
9909300										
9924940										
9907770			9910790	9910790	9910790		9910790			9910790
9935270			9935570	9935570	9935570	9935410	9935570	9935370		9935570
9923030										
9911060										
9910020			9910020	9910020	9910020		9910020		9910020	
			9924770	9924770	9924770				9924770	9925830
			9908660	9908660	9908660				9908660	9925800
9911090										
9931140	9931140									
9931340	9931340									
MA00001			MA00019		MA00019			MA00019	MA00019	MA00019
9913300										
		9933350								
9908370			9912550	9912550	9912550				9912550	
9931670			9910780	9910780						
9931650										

SCOOTER 50cc



		Peugeot	Peugeot	Peugeot	Peugeot	Peugeot	Peugeot
		Metal X	Metal-X	Metropolis	Rapido	ST	SV Geo
		-00	-	-00	-00	-00	-00
		50cc 2T AC	50cc 2T AC	50cc 2T AC	50cc 2T AC	50cc 2T AC	50cc 2T AC
		Motore Peugeot		Motore Peugeot	Motore Peugeot	Motore Peugeot	Motore Peugeot
ALBERO MOTORE		Con Cuscinetti e Paraoli					IM07061
		Senza Cuscinetti e Paraoli					IM07016
ACCENSIONE		Fissa					
		Variabile					
		Digitale					
CAMPANA FRIZIONE							
CINGHIA DI TRASMISSIONE		Ø Standard					
		Ø Maggiorato					
CONVERTITORE DI COPPIA							
FRIZIONE CENTRIFUGA		Interno Ø 105					
		Interno Ø 107	9910020				9910020
GRUPPO TERMICO		Ø Standard	9924770				9924770
		Magg. c/testa	9908660				9908660
		Magg. s/testa					
		Modifica da AC a LC					
GRUPPO TERMICO BLACK TROPHY		Ø Standard					
		Ø Maggiorato					
MOTORINO D'AVVIAMENTO			MA00019				
RAPPORTO ALLUNGATO		Primari					
		Secondari					
SCARICO POWERED 2		Omologato		9932930			
SCARICO HP 2		Omologato		9933350			
VALVOLA LAMELLARE			9912550	9912550	9912550	9912550	9912550
VARIOTOP		TPR c/cinghia					
		TPR s/cinghia					

SCOOTER 50cc

Peugeot	Peugeot	Peugeot	Peugeot	Peugeot	Peugeot	Peugeot	Peugeot	Peugeot	Peugeot	Peugeot
Speedake	Speedfight	Speedfight	Speedfight	Speedfight 3	Speedflight	Squab	Squab	Trekker	Trekker	V-Clic
-00	-00	-00	-	-00	-	-00	-	-00	-	-00
50cc 2T AC	50cc 2T AC	50cc 2T LC	50cc 2T AC	50cc 2T AC	50cc 2T AC	50cc 2T AC	50cc 2T AC	50cc 2T AC	50cc 2T AC	50cc 4T AC
Motore Peugeot	Motore Peugeot	Motore Peugeot		Motore Peugeot		Motore Peugeot		Motore Peugeot		Tipo Kymco
IM07061	IM07061	IM07061				IM07061		IM07061		
IM07016	IM07016	IM07016				IM07016		IM07016		
9910790	9910790	9910790				9910790		9910790		
9935570	9935570	9935570				9935570		9935570		
9910020	9910020	9910020				9910020		9910020		
9924770	9924770	9925640		9925830		9924770		9924770		
9908660	9908660	9919540		9925800		9908660		9908660		
										9925140
MA00019	MA00019	MA00019		MA00019		MA00019		MA00019		
			9932930		9932930		9932930			
			9933340		9933340		9933350		9933350	
9912550	9912550	9912550				9912550		9912550		
9910780										

SCOOTER 50cc



		Peugeot	Peugeot	Peugeot	Peugeot	Peugeot	Peugeot
		Vivacity	Vivacity	X-Fight	X-Fight	X-Fight Kat	Zenith
		-00	-	-00	-00	-	-00
		50cc 2T AC	50cc 2T AC	50cc 2T AC	50cc 2T LC	50cc 2T AC	50cc 2T AC
		Motore Peugeot		Motore Peugeot	Motore Peugeot		Motore Peugeot
ALBERO MOTORE		Con Cuscinetti e Paraoli IM07061		IM07061	IM07061		IM07061
		Senza Cuscinetti e Paraoli IM07016		IM07016	IM07016		IM07016
ACCENSIONE		Fissa					
		Variabile					
		Digitale					
CAMPANA FRIZIONE							
CINGHIA DI TRASMISSIONE		Ø Standard 9910790		9910790			
		Ø Maggiorato 9935570		9935570			
CONVERTITORE DI COPPIA							
FRIZIONE CENTRIFUGA		Interno Ø 105					
		Interno Ø 107 9910020		9910020			9910020
GRUPPO TERMICO		Ø Standard 9924770		9924770	9925640		9924770
		Magg. c/testa 9908660		9908660	9919540		9908660
		Magg. s/testa					
		Modifica da AC a LC					
GRUPPO TERMICO BLACK TROPHY		Ø Standard					
		Ø Maggiorato					
MOTORINO D'AVVIAMENTO			MA00019	MA00019	MA00019		MA00019
RAPPORTO ALLUNGATO		Primari					
		Secondari					
SCARICO POWERED 2		Omologato				9932930	
SCARICO HP 2		Omologato		9933350		9933340	
VALVOLA LAMELLARE			9912550	9912550	9912550		9912550
VARIOTOP		TPR c/cinghia					
		TPR s/cinghia					

SCOOTER 50cc

Piaggio	Piaggio	Piaggio	Piaggio	Piaggio	Piaggio	Piaggio	Piaggio	Piaggio	Piaggio	Piaggio
Diesis	Fly	Fly 2T	Fly 2T	Fly 4T	Fly 4T & 25-30 KM/H	Fly 4T Motore CHN	Free	Free Delivery	Free FL	Liberty
01-01	-	05-07	10-11	05-07	08-11	06-07	92-94	00-01	95-02	97-05
50cc 2T AC	50cc 2T AC	50cc 2T AC	50cc 2T AC	50cc 4T AC	50cc 4T AC	50cc 4T AC	50cc 2T AC	50cc 2T AC	50cc 2T AC	50cc 2T AC
Motore Piaggio		Motore Piaggio	Motore Piaggio	Motore Piaggio	Motore Piaggio	Motore Piaggio	Motore Piaggio	Motore Piaggio	Motore Piaggio	Motore Piaggio
IM07060		IM07060	IM07060				IM07060	IM07060	IM07060	IM07060
IM07015		IM07015	IM07015				IM07015	IM07015	IM07015	IM07015
							9924870	9924870	9924870	9924870
							9924880	9924880	9924880	9924880
				9926150	9926150	9926150				
9924950		9924950	9924950				9924950	9924950	9924950	9924950
9922030							9913280	9922030	9913280	
9935830		9935420		9935480			9935800	9935830	9935800	
9923150		9923150	9923150	9923150	9923150	9923150	9923150	9923150	9923150	9923150
9910020		9910020	9910020	9910020	9910020	9910020	9910020	9910020		9910020
9914500		9914500	9914500				9914500	9914500	9914500	9914500
				9925150	9925150	9925150				
9931250		9931250	9931250				9931250	9931250	9931250	9931250
MA00002		MA00002	MA00002	MA00015	MA00015	MA00015	MA00002	MA00002	MA00002	MA00002
	9932980									
9910930		9910930	9910930				9910930	9910930	9910930	9910930
9931300										
9927610		9927610	9927610	9927610	9927610	9927610	9927610	9927610	9927610	9927610

SCOOTER 50cc



		Piaggio	Piaggio	Piaggio	Piaggio	Piaggio	Piaggio
		Liberty 2T	Liberty 2T	Liberty 2T PTT EU2	Liberty 2T RST	Liberty 2T Sport	Liberty 2T Sport
		06-06	07-08	04-05	04-04	06-06	07-08
		50cc 2T AC	50cc 2T AC	50cc 2T AC	50cc 2T AC	50cc 2T AC	50cc 2T AC
		Motore Piaggio	Motore Piaggio	Motore Piaggio	Motore Piaggio	Motore Piaggio	Motore Piaggio
ALBERO MOTORE		Con Cuscinetti e Paraoli	IM07060	IM07060	IM07060	IM07060	IM07060
		Senza Cuscinetti e Paraoli	IM07015	IM07015	IM07015	IM07015	IM07015
ACCENSIONE		Fissa					
		Variabile					
		Digitale					
CAMPANA FRIZIONE		9924950	9924950	9924950	9924950	9924950	9924950
CINGHIA DI TRASMISSIONE		Top					
		Mitsuboshi				9935420	
CONVERTITORE DI COPPIA		9923150	9923150	9923150	9923150	9923150	9923150
FRIZIONE CENTRIFUGA		Interno Ø 105					
		Interno Ø 107	9910020	9910020	9910020	9910020	9910020
GRUPPO TERMICO		Ø Standard	9914500	9914500	9914500	9914500	9914500
		Magg. c/testa					
		Magg. s/testa					
		Modifica da AC a LC					
GRUPPO TERMICO BLACK TROPHY		Ø Standard					
		Ø Maggiorato	9931250	9931250	9931250	9931250	9931250
MOTORINO D'AVVIAMENTO		MA00002	MA00002	MA00002	MA00002	MA00002	MA00002
RAPPORTO ALLUNGATO		Primari					
		Secondari					
SCARICO POWERED 2							
SCARICO HP 2							
VALVOLA LAMELLARE		9910930	9910930	9910930	9910930	9910930	9910930
VARIOTOP		TPR c/cinghia					
		TPR s/cinghia	9927610	9927610	9927610	9927610	9927610

SCOOTER 50cc

Piaggio	Piaggio	Piaggio	Piaggio	Piaggio	Piaggio	Piaggio	Piaggio	Piaggio	Piaggio	Piaggio
Liberty 4T	Liberty 4T	Liberty 4T Delivery - Single	Liberty 4T Delivery TNT	Liberty 4T PTT - DOUBLE	Liberty 4T RST	Liberty 4T Sport	Liberty 4T Sport	Liberty MOC 2T & Elle	Liberty MOC 4T & Elle	NRG
00-02	05-08	10-12	09-09	09-12	04-04	06-06	07-08	-	09-13	94-96
50cc 4T AC	50cc 4T AC	50cc 4T AC	50cc 4T AC	50cc 4T AC	50cc 4T AC	50cc 4T AC	50cc 4T AC	50cc 2T AC	50cc 4T AC	50cc 2T LC
Motore Piaggio	Motore Piaggio	Motore Piaggio	Motore Piaggio	Motore Piaggio	Motore Piaggio	Motore Piaggio	Motore Piaggio	Motore Piaggio	Motore Piaggio	Motore Piaggio
								IM07060		IM07060
								IM07015		IM07015
9926150	9926150	9926150	9926150	9926150	9926150	9926150	9926150		9926150	
								9924950		9924950
										9913280
										9935800
9923150	9923150	9923150	9923150	9923150	9923150	9923150	9923150	9923150	9923150	9923150
9910020	9910020	9910020	9910020	9910020	9910020	9910020	9910020	9910020	9910020	9910020
								9914500		9916580
9925150	9925150	9925150	9925150	9925150	9925150	9925150	9925150		9925150	
								9931250		9931270
MA00015	MA00015	MA00015	MA00015	MA00015	MA00015	MA00015	MA00015	MA00015		MA00002
								9910930		9910930
								9927610		9927610

SCOOTER 50cc



Piaggio	Piaggio	Piaggio	Piaggio	Piaggio	Piaggio
NRG	NRG Extreme	NRG MC2	NRG MC2	NRG MC2	NRG MC2
-	99-00	-	-	-	-
50cc 2T AC	50cc 2T LC	50cc 2T AC	50cc 2T AC	50cc 2T AC	50cc 2T AC
	Motore Piaggio				

ALBERO MOTORE		Con Cuscinetti e Paraoli		IM07060				
		Senza Cuscinetti e Paraoli		IM07015				
ACCENSIONE		Fissa		9924870				
		Variabile		9924880				
		Digitale						
CAMPANA FRIZIONE				9924950				
CINGHIA DI TRASMISSIONE		Top						
		Mitsuboshi						
CONVERTITORE DI COPPIA				9923150				
FRIZIONE CENTRIFUGA		Interno Ø 105						
		Interno Ø 107						
GRUPPO TERMICO		Ø Standard		9916580				
		Magg. c/testa						
		Magg. s/testa						
		Modifica da AC a LC						
GRUPPO TERMICO BLACK TROPHY		Ø Standard						
		Ø Maggiorato		9931270				
MOTORINO D'AVVIAMENTO				MA00002				
RAPPORTO ALLUNGATO		Primari						
		Secondari						
SCARICO POWERED 2		Omologato	9932920		9932920	9932920	9932920	9932920
SCARICO HP 2		Omologato			9933310		9933310	
VALVOLA LAMELLARE				9910930				
VARIOTOP		TPR c/cinghia						
		TPR s/cinghia		9927610				

SCOOTER 50cc



Piaggio	Piaggio	Piaggio	Piaggio	Piaggio	Piaggio
NRG Power Pure Jet	NRG Power PureJet	NRG Power PureJet	NRG Power PureJet	NRG PureJet	NRG PureJet
04-05	06-06	07-09	10-11	02-04	10-10
50cc 2T-IE LC	50cc 2T-IE LC	50cc 2T-IE LC	50cc 2T-IE LC	50cc 2T-IE LC	50cc 2T-IE LC
Motore Piaggio	Motore Piaggio	Motore Piaggio	Motore Piaggio	Motore Piaggio	Motore Piaggio

ALBERO MOTORE		Con Cuscinetti e Paraoli							
		Senza Cuscinetti e Paraoli	IM07064	IM07064	IM07064	IM07064	IM07064	IM07064	IM07064
ACCENSIONE		Fissa							
		Variabile							
		Digitale							
CAMPANA FRIZIONE			9924950	9924950	9924950	9924950	9924950	9924950	9924950
CINGHIA DI TRASMISSIONE		Top	9922030	9922030	9922030	9922030	9922030	9922030	9922030
		Mitsuboshi	9935830	9935830	9935830	9935830	9935830	9935830	9935830
CONVERTITORE DI COPPIA			9923150	9923150	9923150	9923150	9923150	9923150	9923150
FRIZIONE CENTRIFUGA		Interno Ø 105							
		Interno Ø 107							
GRUPPO TERMICO		Ø Standard	9916580	9916580	9916580	9916580	9916580	9916580	9916580
		Magg. c/testa							
		Magg. s/testa							
		Modifica da AC a LC							
GRUPPO TERMICO BLACK TROPHY		Ø Standard							
		Ø Maggiorato	9931270	9931270	9931270	9931270	9931270	9931270	9931270
MOTORINO D'AVVIAMENTO			MA00015	MA00015	MA00015	MA00015	MA00015	MA00015	MA00015
RAPPORTO ALLUNGATO		Primari							
		Secondari							
SCARICO POWERED 2									
SCARICO HP 2									
VALVOLA LAMELLARE			9910930	9910930	9910930	9910930	9910930	9910930	9910930
VARIOTOP		TPR c/cinghia	9931300	9931300	9931300	9931300	9931300	9931300	9931300
		TPR s/cinghia	9927610	9927610	9927610	9927610	9927610	9927610	9927610

SCOOTER 50cc

Piaggio	Piaggio	Piaggio	Piaggio	Piaggio	Piaggio	Piaggio	Piaggio	Piaggio	Piaggio	Piaggio
NRG RST MC2	NTT	Quartz	Sfera	Sfera Maquillage 2	Sfera RST	Typhoon	Typhoon	Typhoon	Typhoon 2T E2	Typhoon 2T E3 CH
96-98	95-96	92-96	91-93	94-94	95-97	01-04	05-08	09-11	10-12	11-11
50cc 2T LC	50cc 2T LC	50cc 2T LC	50cc 2T AC	50cc 2T AC	50cc 2T AC	50cc 2T AC	50cc 2T AC	50cc 2T AC	50cc 2T AC	50cc 2T AC
Motore Piaggio	Motore Piaggio	Motore Piaggio	Motore Piaggio	Motore Piaggio	Motore Piaggio	Motore Piaggio	Motore Piaggio	Motore Piaggio	Motore Piaggio	Motore Piaggio
IM07060	IM07060	IM07060	IM07060	IM07060	IM07060	IM07060	IM07060	IM07060	IM07060	IM07060
IM07015	IM07015	IM07015	IM07015	IM07015	IM07015	IM07015	IM07015	IM07015	IM07015	IM07015
9924870	9924870	9924870	9924870	9924870	9924870					
9924880	9924880	9924880	9924880	9924880	9924880					
9924950	9924950	9924950	9924950	9924950	9924950	9924950	9924950	9924950	9924950	9924950
9913280	9913280	9913350	9913360	9913360	9913350	9922030	9922030	9922030		
9935800	9935800	9935810			9935810	9935830	9935830	9935830	9935420	9935420
9923150	9923150	9923150	9923150	9923150	9923150	9923150	9923150	9923150	9923150	9923150
9910020	9910020	9910020	9910020	9910020	9910020				9910020	9910020
9916580	9916580	9916580	9914500	9914500	9914500	9914500	9914500	9914500	9914500	9914500
9931270	9931270	9931270	9931250	9931250	9931250	9931250	9931250	9931250	9931250	9931250
MA00002	MA00002	MA00002	MA00002	MA00002	MA00002	MA00002	MA00002	MA00002	MA00002	MA00002
9910930	9910930	9910930	9910930	9910930	9910930	9910930	9910930	9910930	9910930	9910930
						9931300	9931300	9931300		
9927610	9927610	9927610	9927610	9927610	9927610	9927610	9927610	9927610	9927610	9927610

SCOOTER 50cc



Piaggio	Piaggio	Piaggio	Piaggio	Piaggio	Piaggio
Vespa	Vespa ET2	Vespa ET2 iniezione	Vespa ET4	Vespa Et2	Vespa FL
67-82	97-05	97-00	00-05	-	90-90
50cc 2T AC	50cc 2T AC	50cc 2T AC	50cc 4T AC	50cc 2T AC	50cc 2T AC
	Motore Piaggio	Motore Piaggio	Motore Piaggio		

ALBERO MOTORE		Con Cuscinetti e Paraoli		IM07060	IM07060			
		Senza Cuscinetti e Paraoli	IM07005	IM07015	IM07015			IM07007
ACCENSIONE		Fissa		9924870				
		Variabile		9924880				
		Digitale				9926150		
CAMPANA FRIZIONE				9924950	9924950			
CINGHIA DI TRASMISSIONE		Top		9913280	9922040	9922040		
		Mitsuboshi		9935800	9935840	9935840		
CONVERTITORE DI COPPIA				9923150	9923150	9923150		
FRIZIONE CENTRIFUGA		Interno Ø 105						
		Interno Ø 107		9910020		9910020		
GRUPPO TERMICO		Ø Standard		9914500	9914500			
		Magg. c/testa						
		Magg. s/testa				9925150		
		Modifica da AC a LC						
GRUPPO TERMICO BLACK TROPHY		Ø Standard						
		Ø Maggiorato		9931250	9931250			
MOTORINO D'AVVIAMENTO				MA00002	MA00002	MA00015		MA00023
RAPPORTO ALLUNGATO		Primari						
		Secondari						
SCARICO POWERED 2		Omologato					9932910	
SCARICO HP 2		Omologato						
VALVOLA LAMELLARE				9910930	9910930			
VARIOTOP		TPR c/cinghia			9931260	9931260		
		TPR s/cinghia		9927610	9927610	9927610		

SCOOTER 50cc

Piaggio	Piaggio	Piaggio	Piaggio	Piaggio	Piaggio	Piaggio	Piaggio	Piaggio	Piaggio	Piaggio
Vespa FL2 Automatica	Vespa FL2 HP	Vespa LX 2T	Vespa LX 2T FL	Vespa LX 2T Touring	Vespa LX 4T	Vespa LX 4T 4V	Vespa LX 4T 4V Touring	Vespa LXV 2T	Vespa LXV 2T NAVY	Vespa N
90-91	91-97	05-08	09-10	10-11	05-08	09-11	10-11	-	08-08	89-90
50cc 2T AC	50cc 2T AC	50cc 2T AC	50cc 2T AC	50cc 2T AC	50cc 4T AC	50cc 4T-4V AC	50cc 4T-4V AC	50cc 2T AC	50cc 2T AC	50cc 2T AC
		Motore Piaggio	Motore Piaggio	Motore Piaggio	Motore Piaggio	Motore Piaggio	Motore Piaggio	Motore Piaggio	Motore Piaggio	
		IM07060	IM07060	IM07060				IM07060	IM07060	
		IM07015	IM07015	IM07015				IM07015	IM07015	IM07007
					9926150					
		9924950	9924950	9924950				9924950	9924950	
		9922040	9922040	9922040	9922040	9922040	9922040	9922040	9922040	
		9935840	9935840	9935840	9935840	9935840	9935840	9935840	9935840	
		9923150	9923150	9923150	9923150	9923150	9923150	9923150	9923150	
		9914500	9914500	9914500				9914500	9914500	
					9925150	9928300	9928300			
		9931250	9931250	9931250				9931250	9931250	
MA00023	MA00023	MA00002		MA00002	MA00015	MA00015	MA00015	MA00002	MA00002	MA00023
		9910930	9910930	9910930				9910930	9910930	
		9931260	9931260	9931260	9931260	9931260	9931260	9931260	9931260	
		9927610	9927610	9927610	9927610	9927610	9927610	9927610	9927610	

SCOOTER 50cc



Piaggio	Piaggio	Piaggio	Piaggio	Piaggio	Piaggio
Vespa PK	Vespa PK Automatica	Vespa PK XL	Vespa PK XL PLURIMATIC	Vespa PK XL RUSH	Vespa S 2T & College
82-84	84-89	85-88	85-90	88-89	07-12
50cc 2T AC	50cc 2T AC	50cc 2T AC	50cc 2T AC	50cc 2T AC	50cc 2T AC
					Motore Piaggio

ALBERO MOTORE		Con Cuscinetti e Paraoli							IM07060
		Senza Cuscinetti e Paraoli	IM07007			IM07007			IM07007
ACCENSIONE		Fissa							
		Variabile							
		Digitale							
CAMPANA FRIZIONE									9924950
CINGHIA DI TRASMISSIONE		Top							9922040
		Mitsuboshi							9935840
CONVERTITORE DI COPPIA									9923150
FRIZIONE CENTRIFUGA		Interno Ø 105							
		Interno Ø 107							
GRUPPO TERMICO		Ø Standard							9914500
		Magg. c/testa							
		Magg. s/testa							
		Modifica da AC a LC							
GRUPPO TERMICO BLACK TROPHY		Ø Standard							
		Ø Maggiorato							9931250
MOTORINO D'AVVIAMENTO			MA00023	MA00023	MA00023	MA00023	MA00023	MA00023	MA00002
RAPPORTO ALLUNGATO		Primari							
		Secondari							
SCARICO POWERED 2		Omologato							
SCARICO HP 2		Omologato							
VALVOLA LAMELLARE									9910930
VARIOTOP		TPR c/cinghia							9931260
		TPR s/cinghia							9927610

SCOOTER 50cc

Piaggio	Piaggio	Piaggio	Piaggio	Piaggio	Piaggio	Piaggio	Piaggio	Piaggio	Piaggio	Piaggio
Vespa S 4T 4V & College	Zip	Zip	Zip 2T	Zip 4T	Zip 4T	Zip Bimodale	Zip Fast Rider	Zip Fast Rider	Zip Fast Rider RST	Zip Kat
08-11	92-93	95-96	-	00-05	06-13	94-97	93-94	-	96-97	-
50cc 4T-4V AC	50cc 2T AC	50cc 2T AC	50cc 2T LC	50cc 4T AC	50cc 4T AC	50cc 2T AC	50cc 2T AC	50cc 2T AC	50cc 2T AC	50cc 2T AC
Motore Piaggio	Motore Piaggio	Motore Piaggio	Motore Piaggio	Motore Piaggio	Motore Piaggio	Motore Piaggio	Motore Piaggio		Motore Piaggio	
	IM07060	IM07060	IM07060			IM07060	IM07060		IM07060	
	IM07015	IM07015	IM07015			IM07015	IM07015		IM07015	
	9924870	9924870				9924870	9924870		9924870	
	9924880	9924880				9924880	9924880		9924880	
				9926150	9926150					
	9924950	9924950	9924950			9924950	9924950		9924950	
9922040	9913360	9913350	9922040	9922040	9922040	9913350	9913350		9913350	
9935840		9935810	9935840	9935840	9935840	9935810	9935810		9935810	
9923150	9923150	9923150	9923150	9923150	9923150	9923150	9923150		9923150	
	9910020	9910020		9910020	9910020	9910020	9910020		9910020	
	9914500	9914500	9916580			9914500	9914500		9914500	
9928300				9925150	9925150					
	9931250	9931250	9931270			9931250	9931250		9931250	
MA00015	MA00002	MA00002	MA00002	MA00015	MA00015	MA00002	MA00002		MA00002	
										9932980
								9933330		
	9910930	9910930	9910930			9910930	9910930		9910930	
9931260			9931260	9931260	9931260					
9927610	9927610	9927610	9927610	9927610	9927610	9927610	9927610		9927610	

SCOOTER 50cc



		Piaggio	Piaggio	Piaggio	Piaggio	Piaggio	Piaggio
		Zip LC	Zip RST	Zip Sp	Zip Sp	Zip Sp	Zip Sp Euro 2
		00-04	96-99	96-00	01-04	-	-
		50cc 2T LC	50cc 2T AC	50cc 2T LC	50cc 2T LC	50cc 2T AC	50cc 2T LC
		Motore Piaggio	Motore Piaggio	Motore Piaggio	Motore Piaggio		Motore Piaggio
ALBERO MOTORE		Con Cuscinetti e Paraoli	IM07060	IM07060	IM07060		IM07060
		Senza Cuscinetti e Paraoli	IM07015	IM07015	IM07015		IM07015
ACCENSIONE		Fissa		9924870	9924870		
		Variabile		9924880	9924880		
		Digitale					
CAMPANA FRIZIONE			9924950	9924950	9924950		9924950
CINGHIA DI TRASMISSIONE		Top	9922040	9913350	9913350	9922040	9922040
		Mitsuboshi	9935840	9935810	9935810	9935840	9935840
CONVERTITORE DI COPPIA			9923150	9923150	9923150		9923150
FRIZIONE CENTRIFUGA		Interno Ø 105					
		Interno Ø 107		9910020	9910020		
GRUPPO TERMICO		Ø Standard	9916580	9914500	9916580	9916580	9916580
		Magg. c/testa					
		Magg. s/testa					
		Modifica da AC a LC					
GRUPPO TERMICO BLACK TROPHY		Ø Standard					
		Ø Maggiorato	9931270	9931250	9931270	9931270	9931270
MOTORINO D'AVVIAMENTO			MA00002	MA00015	MA00002	MA00002	MA00002
RAPPORTO ALLUNGATO		Primari					
		Secondari					
SCARICO POWERED 2						9932920	
SCARICO HP 2							
VALVOLA LAMELLARE			9910930	9910930	9910930		9910930
VARIOTOP		TPR c/cinghia	9931260		9931260	9931260	9931260
		TPR s/cinghia	9927610	9927610	9927610	9927610	9927610

SCOOTER 50cc

Rieju	Rieju	Rieju	Rieju	Rieju	Suzuki	Suzuki	Suzuki	Suzuki	Sym	Sym
First	Pacific	Paseo	Toreo	Windy	Katana	Katana	Katana	Zillion	DD	Eurojet
-00	-00	-00	-00	-00	97-00	97-00	01-04	99-99	02-02	-
50cc 2T AC	50cc 4T AC	50cc 4T AC	50cc 4T AC	50cc 2T AC	50cc 2T LC	50cc 2T AC	50cc 2T LC	50cc 2T LC	50cc 2T AC	50cc 2T AC
MY	Tipo Kymco	Tipo Kymco	Tipo Kymco	MY	Motore Suzuki	Motore Suzuki	Motore Suzuki	Motore Suzuki		
IM07059				IM07059						
IM07014				IM07014						
9924940				9924940						
9907770				9907770	9920440	9920440	9920440	9920440		
9935270				9935270	9935820	9935820	9935820	9935820		
9923030				9923030						
9911060				9911060						
9910020				9910020						
	9925140	9925140	9925140							
9911090				9911090						
9931140				9931140						
9931340				9931340						
MA00001				MA00001						
9913300				9913300						
										9932900
9908370				9908370					9912550	
9931670				9931670						
9931650				9931650						

SCOOTER 50cc



Sym	Sym	Sym	Sym	Sym	Sym
Jet	Jungle	MIO	Mask	Mask EU2	Red Devil
99-01	99-00	06-09	00-01	03-04	99-99
50cc 2T AC	50cc 2T AC	50cc 4T AC	50cc 2T AC	50cc 2T AC	50cc 2T AC

ALBERO MOTORE		Con Cuscinetti e Paraoli Senza Cuscinetti e Paraoli					
ACCENSIONE		Fissa Variabile Digitale					
CAMPANA FRIZIONE							
CINGHIA DI TRASMISSIONE		Top Mitsuboshi					
CONVERTITORE DI COPPIA							
FRIZIONE CENTRIFUGA		Interno Ø 105 Interno Ø 107					
GRUPPO TERMICO		Ø Standard Magg. c/testa Magg. s/testa Modifica da AC a LC					
GRUPPO TERMICO BLACK TROPHY		Ø Standard Ø Maggiorato					
MOTORINO D'AVVIAMENTO			MA00014	MA00014	MA00024	MA00014	MA00014
RAPPORTO ALLUNGATO		Primari Secondari					
SCARICO POWERED 2		Omologato					
SCARICO HP 2		Omologato					
VALVOLA LAMELLARE							
VARIOTOP		TPR c/cinghia TPR s/cinghia					

SCOOTER 50cc

Sym	Sym	Sym	Sym	Sym	WT Motors	Yamaha	Yamaha	Yamaha	Yamaha	Yamaha
Super Fancy	Symphony Euro 2	Symphony S	Symphony SR	Symply Euro 2	Bilbao	Aerox	Aerox	Aerox Euro 2	Aerox Kat	Aerox Kat
98-00	09-09	10-10	10-10	07-08	-00	-00	-	03-03	-	-
50cc 2T AC	50cc 4T AC	50cc 4T AC	50cc 4T AC	50cc 4T AC	50cc 4T AC	50cc 2T LC	50cc 2T AC	50cc 2T LC	50cc 2T AC	50cc 2T AC
				Tipo Kymco	Tipo Kymco	MA		MA		
						IM07059		IM07059		
						IM07014		IM07014		
						9910100				
						9909230				
								9921790		
						9924940		9924940		
	9920440					9907770		9907770		
	9935820					9935270		9935270		
						9923030		9923030		
						9911060		9911060		
						9910020		9910020		
				9925140	9925140					
						9931110		9931110		
						9931310		9931310		
MA00014	MA00024	MA00024	MA00024			MA00001		MA00001		
						9913300		9913300		
						9909520		9909520		
							9932960			
							9933360		9933360	9933380
						9908370		9908370		
						9931670		9931670		
						9931650		9931650		

SCOOTER 50cc



Yamaha	Yamaha	Yamaha	Yamaha	Yamaha	Yamaha
Axis	BWS	BWS Bump	BWS Euro 2	BWS NG	BWS NG Euro 2
95-96	-00	97-98	03-03	-00	03-03
50cc 2T AC	50cc 2T AC	50cc 2T AC	50cc 2T AC	50cc 2T AC	50cc 2T AC
CY	CW	CW	CW	CW	CW

ALBERO MOTORE		Con Cuscinetti e Paraoli	IM07059	IM07058	IM07058	IM07058	IM07058	IM07058
		Senza Cuscinetti e Paraoli	IM07014	IM07013	IM07013	IM07013	IM07013	IM07013
ACCENSIONE		Fissa	9910100	9910100	9910100		9910100	
		Variabile	9909230	9909230	9909230		9909230	
		Digitale				9921790		9921790
CAMPANA FRIZIONE			9924940					
CINGHIA DI TRASMISSIONE		Top	9907900	9907770	9907770	9907770	9907770	9907770
		Mitsuboshi	9935340	9935270	9935270	9935270	9935270	9935270
CONVERTITORE DI COPPIA			9923030	9923030	9923030	9923030	9923030	9923030
FRIZIONE CENTRIFUGA		Interno Ø 105		9911060	9911060	9911060	9911060	9911060
		Interno Ø 107		9910020	9910020	9910020	9910020	9910020
GRUPPO TERMICO		Ø Standard						
		Magg. c/testa						
		Magg. s/testa						
		Modifica da AC a LC	9911090					
GRUPPO TERMICO BLACK TROPHY		Ø Standard	9931140	9931170	9931170	9931170	9931170	9931170
		Ø Maggiorato	9931340	9931370	9931370	9931370	9931370	9931370
MOTORINO D'AVVIAMENTO			MA00001	MA00001	MA00001	MA00001	MA00001	MA00001
RAPPORTO ALLUNGATO		Primari	9913310	9913300	9913300	9913300	9913300	9913300
		Secondari					9909520	9909520
SCARICO POWERED 2		Omologato						
SCARICO HP 2		Omologato						
VALVOLA LAMELLARE			9908370	9906520	9906520	9906520	9906520	9906520
VARIOTOP		TPR c/cinghia	9931690	9931670	9931670	9931670	9931670	9931670
		TPR s/cinghia	9931650	9931650	9931650	9931650	9931650	9931650

SCOOTER 50cc

Yamaha	Yamaha	Yamaha	Yamaha	Yamaha	Yamaha	Yamaha	Yamaha	Yamaha	Yamaha	Yamaha
BW'S	BW'S Kat	BW'S Next Generation	BW'S Next Generation Kat	Breeze	CRZ	CT	Giggle	Jog	Jog ER	Jog R
-	-	-	-	94-95	91-95	90-95	08-08	-00	-00	02-10
50cc 2T AC	50cc 2T AC	50cc 2T AC	50cc 2T AC	50cc 2T AC	50cc 2T AC	50cc 2T AC	50cc 4T-3V LC	50cc 2T AC	50cc 2T AC	50cc 2T AC
				CY	Tipo CW	Tipo CW	15P1	Tipo CY	Tipo CY	MY
				IM07059				IM07059		IM07059
				IM07014				IM07014		IM07014
				9910100				9910100	9910100	
				9909230				9909230	9909230	
										9921790
				9924940				9924940		9924940
				9907900	9907900			9907900		9907770
				9935340	9935340		9935590	9935340		9935270
				9923030				9923030		9923030
					9911060	9911060				9911060
					9910020	9910020				9910020
				9911090				9911090		9911090
				9931140				9931140		9931140
				9931340				9931340		9931340
				MA00001						MA00001
				9913310				9913310	9913310	9913300
9932950		9932950								
9933370	9933370	9933370	9933370							
				9908370				9908370	9908370	9908370
				9931690				9931690		9931670
				9931650			9926130	9931650		9931650

SCOOTER 50cc



Yamaha	Yamaha	Yamaha	Yamaha	Yamaha	Yamaha
Jog R LC	Jog Z	Neo'S	Neo's	Neo's 4	Neo's Euro 2
-00	95-95	-	-00	09-11	02-02
50cc 2T LC	50cc 2T AC	50cc 2T AC		50cc 4T-3V LC	50cc 2T AC
MA	Tipo CY		MY	5C3	MY

ALBERO MOTORE		Con Cuscinetti e Paraoli	IM07059			IM07059			IM07059
		Senza Cuscinetti e Paraoli	IM07014			IM07014			IM07014
ACCENSIONE		Fissa		9910100		9910100			
		Variabile		9909230		9909230			
		Digitale	9921790						9921790
CAMPANA FRIZIONE			9924940			9924940			9924940
CINGHIA DI TRASMISSIONE		Top	9907770			9907770			9907770
		Mitsuboshi	9935270			9935270			9935270
CONVERTITORE DI COPPIA			9923030			9923030			9923030
FRIZIONE CENTRIFUGA		Interno Ø 105	9911060			9911060			9911060
		Interno Ø 107	9910020			9910020			9910020
GRUPPO TERMICO		Ø Standard							
		Magg. c/testa							
		Magg. s/testa							
		Modifica da AC a LC				9911090			9911090
GRUPPO TERMICO BLACK TROPHY		Ø Standard	9931110			9931140			9931140
		Ø Maggiorato	9931310			9931340			9931340
MOTORINO D'AVVIAMENTO			MA00001			MA00001			MA00001
RAPPORTO ALLUNGATO		Primari	9913300	9913310		9913300			9913300
		Secondari	9909520						
SCARICO POWERED 2		Omologato			9932940				
SCARICO HP 2		Omologato							
VALVOLA LAMELLARE			9908370	9908370		9908370			9908370
VARIOTOP		TPR c/cinghia	9931670			9931670			9931670
		TPR s/cinghia	9931650			9931650	9926130		9931650

SCOOTER 50cc

Yamaha	Yamaha	Yamaha	Yamaha	Yamaha	Yamaha	Yamaha	Yamaha	Yamaha
Slider	Slider Kat	Spy	Spy	Why	Why Euro 2	Zest	Zuma	Zuma
00-02	-	95-98	-	-00	03-03	-00	97-01	02-10
50cc 2T AC	50cc 2T AC	50cc 2T AC	50cc 2T AC	50cc 2T AC	50cc 2T AC	50cc 2T AC	50cc 2T AC	50cc 2T AC
CW		CW		MY	MY	CY	CW	YW
IM07058		IM07058		IM07059	IM07059	IM07059	IM07058	
IM07013		IM07013		IM07014	IM07014	IM07014	IM07013	
9910100		9910100		9910100		9910100	9910100	
9909230		9909230		9909230		9909230	9909230	
					9921790			
				9924940	9924940			
9907770		9907770		9907770	9907770	9907900	9907770	
9935270		9935270		9935270	9935270	9935340	9935270	
9923030		9923030		9923030	9923030	9923030	9923030	
9911060		9911060		9911060	9911060		9911060	
9910020		9910020		9910020	9910020		9910020	
				9911090	9911090	9911090		
9931170		9931170		9931140	9931140	9931140	9931170	
9931370		9931370		9931340	9931340	9931340	9931370	
MA00001		MA00001		MA00001	MA00001	MA00001	MA00001	
9913300		9913300		9913300	9913300	9913310	9913300	
9909520		9909520		9909520	9909520			
	9932950		9932950					
	9933370		9933370					
9906520		9906520		9908370	9908370	9908370	9906520	9908370
9931670		9931670		9931670	9931670	9931690	9931670	
9931650		9931650		9931650	9931650	9931650	9931650	



SCOOTER 50cc RACING



Aprilia	Aprilia	Aprilia	Aprilia	Aprilia	Aprilia
Amico	Amico	Amico GL/ GLE	Amico LX/ Sport/Cat	Area 51	Gulliver
94-94	96-98	93-95	92-93	98-00	95-98
50cc 2T AC	50cc 2T AC	50cc 2T AC	50cc 2T AC	50cc 2T LC	50cc 2T AC
CW	CW	CW	CW	MA	MY

ALBERO MOTORE TPR CORSA STD		Spinotto Ø 10	9927900	9927900	9927900	9927900	9925910	9925910
		Spinotto Ø 12					9928320	9928320
COPERCHIO INGRANAGGI			9930300	9930300	9930300	9930300	9930300	9930300
COPERCHIO TRASMISSIONE							9930200	9930200
CUSCINETTI DI BANCO TPR Carbonitrurati		Serie	9929190	9929190	9929190	9929190	9929190	9929190
FRIZIONE TPR GP REGOLABILE Patented			9927450	9927450	9927450	9927450	9927450	9927450
GRUPPO TERMICO RACING Maggiorato ghisa c/testa			9930000	9930000	9930000	9930000	9912800	9930030
GRUPPO TERMICO RACING 2004 Maggiorato c/testa scomposta							9921160	
GRUPPO TRASFORMAZIONE DA ARIA AD ACQUA - Ghisa								9911210
GRUPPO TERMICO TPR Maggiorato in alluminio		Spinotto Ø 10	9921640	9921640	9921640	9921640	9928480	9921630
		Spinotto Ø 12					9928550	
KIT ASPIRAZIONE COMPLETO		OKO 28					9931710	9931710
		TM 24					9930830	9930830
MAXI KIT 77 CC ALESAGGIO Ø 50 CORSA STD							9926580	
MAXI KIT 86 CC ALESAGGIO Ø 50 CORSA 44 mm							9926560	
RAPPORTO ALLUNGATO							990875P	990875P
SCARICO NARDÒ 2		Omologato	9931450	9931450	9931450	9931450	9931440	9931440
SCARICO TPR GP							9930140	
VALVOLA LAMELLARE TPR							9931620	9931620

SCOOTER 50cc RACING

Aprilia	Aprilia	Aprilia	Aprilia	Aprilia	Aprilia	Aprilia	Aprilia	Aprilia	Aprilia	Aprilia
Gulliver LC	Mojito	Rally	Rally Liquid Cooled	SR (Orizzontale)	SR (Verticale)	SR Liquid Cooled	SR R	SR R FACTORY Carburatore	SR R FACTORY IE	SR R FACTORY IE
96-98	-	95-03	96-99	94-96	93-93	94-96	04-09	-	10-12	-
50cc 2T LC	50cc 2T AC	50cc 2T AC	50cc 2T LC	50cc 2T AC	50cc 2T AC	50cc 2T LC	50cc 2T LC	50cc 2T LC	50cc 2T-IE LC	50cc 2T LC
MA	Motore Piaggio	MY	MA	MY	CW	MA	Motore Piaggio	Motore Piaggio	Motore Piaggio	Motore Piaggio
9925910		9925910	9925910	9925910	9927900	9925910				
9928320	9926180	9928320	9928320	9928320		9928320	9926180	9926180		9926180
9930300		9930300	9930300	9930300	9930300	9930300				
9930200		9930200	9930200	9930200		9930200				
9929190	9929200	9929190	9929190	9929190	9929190	9929190	9929200	9929200		9929200
9927450	9928340	9927450	9927450	9927450	9927450	9927450	9928340	9928340	9928340	9928340
9912800	9930060	9930030	9912800	9930030	9930000	9912800	9920590	9920590		9920590
9921160			9921160			9921160				
		9911210		9911210						
9928480		9921630	9928480	9921630	9921640	9928480				
9928550	9921550		9928550			9928550	9928520	9928520		9928520
9931710	9931730	9931710	9931710	9931710		9931710	9931730	9931730		9931730
9930830	9930870	9930830	9930830	9930830		9930830	9930870	9930870		9930870
9926580			9926580			9926580	9928390	9928390		9928390
9926560			9926560			9926560	9928440	9928440		9928440
990875P		990875P	990875P	990875P	990875P	990875P				
9931440		9931440	9931440	9931440	9931450	9931440	9931460	9931460		9931460
9930140			9930140			9930140	9930160	9930160		9930160
9931620	9931640	9931620	9931620	9931620		9931620	9931640	9931640		9931640

SCOOTER 50cc RACING



Aprilia	Aprilia	Aprilia	Aprilia	Aprilia	Aprilia
SR Recing	SR Stealth	SR Street Carburatore	SR WWW	Scarabeo	Scarabeo
97-99	97-99	03-12	97-01	93-97	98-98
50cc 2T LC	50cc 2T LC	50cc 2T LC	50cc 2T AC	50cc 2T AC	50cc 2T AC
MA	MA	Motore Piaggio	MY	MY	MY

ALBERO MOTORE TPR CORSA STD		Spinotto Ø 10	9925910	9925910		9925910	9925910	9925910
		Spinotto Ø 12	9928320	9928320	9926180	9928320	9928320	9928320
COPERCHIO INGRANAGGI			9930300	9930300		9930300	9930300	9930300
COPERCHIO TRASMISSIONE			9930200	9930200		9930200	9930200	9930200
CUSCINETTI DI BANCO TPR Carbonitrurati		Serie	9929190	9929190	9929200	9929190	9929190	9929190
FRIZIONE TPR GP REGOLABILE Patented			9927450	9927450	9928340	9927450	9927450	9927450
GRUPPO TERMICO RACING Maggiorato ghisa c/testa			9912800	9912800	9920590	9930030	9930030	9930030
GRUPPO TERMICO RACING 2004 Maggiorato c/testa scomposta			9921160	9921160				
GRUPPO TRASFORMAZIONE DA ARIA AD ACQUA - Ghisa						9911210	9911210	9911210
GRUPPO TERMICO TPR Maggiorato in alluminio		Spinotto Ø 10	9928480	9928480		9921630	9921630	9921630
		Spinotto Ø 12	9928550	9928550	9928520			
KIT ASPIRAZIONE COMPLETO		OKO 28	9931710	9931710	9931730	9931710	9931710	9931710
		TM 24	9930830	9930830	9930870	9930830	9930830	9930830
MAXI KIT 77 CC ALESAGGIO Ø 50 CORSA STD			9926580	9926580	9928390			
MAXI KIT 86 CC ALESAGGIO Ø 50 CORSA 44 mm			9926560	9926560	9928440			
RAPPORTO ALLUNGATO			990875P	990875P		990875P		
SCARICO NARDÒ 2		Omologato	9931440	9931440		9931440	9931440	9931440
SCARICO TPR GP			9930140	9930140				
VALVOLA LAMELLARE TPR			9931620	9931620	9931640	9931620	9931620	9931620

SCOOTER 50cc RACING

Aprilia	Aprilia	Aprilia	Aprilia	Aprilia	Aprilia	Aprilia	Aprilia	Aprilia	Aprilia	Aprilia
Scarabeo	Scarabeo	Scarabeo 2T EU2 Mot. Piaggio	Scarabeo 2T Net	Scarabeo 2T Net	Scarabeo 4T	Scarabeo 4T 4V	Scarabeo 4T 4V NET	Scarabeo 4T 4V NET	Scarabeo 4T Restyling EU3	Scarabeo Quattro
99-99	00-05	10-12	09-09	10-10	02-06	10-12	09-09	10-10	06-09	09-09
50cc 2T AC	50cc 2T AC	50cc 2T AC	50cc 2T AC	50cc 2T AC	50cc 4T AC	50cc 4T-4V AC	50cc 4T-4V AC	50cc 4T-4V AC	50cc 4T AC	50cc 4T-4V AC
MY	MY	Motore Piaggio	Motore Piaggio	Motore Piaggio	Motore Piaggio	Motore Piaggio	Motore Piaggio	Motore Piaggio	Motore Piaggio	Motore Piaggio
9925910	9925910									
9928320	9928320	9926180	9926180	9926180						
9930300	9930300									
9930200	9930200									
9929190	9929190	9929200	9929200	9929200						
9927450	9927450	9928340	9928340	9928340	9928340	9928340	9928340	9928340	9928340	9928340
9930030	9930030	9930060	9930060	9930060						
9911210	9911210									
9921630	9921630									
		9921550	9921550	9921550						
9931710	9931710	9931730	9931730	9931730						
9930830	9930830	9930870	9930870	9930870						
		9931460	9931460	9931460						
9931620	9931620	9931640	9931640	9931640						

SCOOTER 50cc RACING



Aprilia	Aprilia	Aprilia	Aprilia	Aprilia	Aprilia
Scarabeo Street	Scarabeo Street 2T Restyling	Sonic	Sonic GP	Sport City One 2T	Sport City One 4T
05-06	06-09	98-07	98-08	08-11	08-10
50cc 2T AC	50cc 2T AC	50cc 2T AC	50cc 2T LC	50cc 2T AC	50cc 4T AC
Motore Piaggio	Motore Piaggio	CY	CA	Motore Piaggio	Motore Piaggio

ALBERO MOTORE TPR CORSA STD		Spinotto Ø 10			9925910	9925910		
		Spinotto Ø 12	9926180	9926180	9928320	9928320	9926180	
COPERCHIO INGRANAGGI								
COPERCHIO TRASMISSIONE								
CUSCINETTI DI BANCO TPR Carbonitrurati		Serie	9929200	9929200	9929190	9929190	9929200	
FRIZIONE TPR GP REGOLABILE Patented			9928340	9928340	9927450	9927450	9928340	9928340
GRUPPO TERMICO RACING Maggiorato ghisa c/testa			9930060	9930060	9930030	9912800	9930060	
GRUPPO TERMICO RACING 2004 Maggiorato c/testa scomposta						9921160		
GRUPPO TRASFORMAZIONE DA ARIA AD ACQUA - Ghisa					9911210			
GRUPPO TERMICO TPR Maggiorato in alluminio		Spinotto Ø 10			9921630	9928480		
		Spinotto Ø 12	9921550	9921550		9928550	9921550	
KIT ASPIRAZIONE COMPLETO		OKO 28	9931730	9931730	9931710	9931710	9931730	
		TM 24	9930870	9930870	9930830	9930830	9930870	
MAXI KIT 77 CC ALESAGGIO Ø 50 CORSA STD						9926580		
MAXI KIT 86 CC ALESAGGIO Ø 50 CORSA 44 mm						9926560		
RAPPORTO ALLUNGATO					990902P	990902P		
SCARICO NARDÒ 2		Omologato	9931460	9931460	9931440	9931440		
SCARICO TPR GP						9930140		
VALVOLA LAMELLARE TPR			9931640	9931640	9931620	9931620	9931640	

SCOOTER 50cc RACING

Atala	Benelli	Benelli	Benelli	Benelli	Benelli	Benelli	Benelli	Benelli	Benelli	Benelli
Carosello	491 GT	491 RR	491 Racing	491 SP	491 ST	491 Sport	K2	K2 Liquid Cooled	Naked	Pepe
-00	98-99	99-01	98-99	99-99	99-01	98-99	98-01	98-01	02-02	99-01
50cc 2T AC	50cc 2T AC	50cc 2T LC	50cc 2T LC	50cc 2T LC	50cc 2T AC	50cc 2T LC	50cc 2T AC	50cc 2T LC	50cc 2T AC	50cc 2T AC
MY	MY	MA	MA	MA	MY	MA	MY	MA	MY	MY
9925910	9925910	9925910	9925910	9925910	9925910	9925910	9925910	9925910	9925910	9925910
9928320	9928320	9928320	9928320	9928320	9928320	9928320	9928320	9928320	9928320	9928320
9930300	9930300	9930300	9930300	9930300	9930300	9930300	9930300	9930300	9930300	9930300
9930200	9930200	9930200	9930200	9930200	9930200	9930200	9930200	9930200	9930200	9930200
9929190	9929190	9929190	9929190	9929190	9929190	9929190	9929190	9929190	9929190	9929190
9927450	9927450	9927450	9927450	9927450	9927450	9927450	9927450	9927450	9927450	9927450
9930030	9930030	9912800	9912800	9912800	9930030	9912800	9930030	9912800	9930030	9930030
		9921160	9921160	9921160		9921160		9921160		
9911210	9911210				9911210		9911210		9911210	9911210
9921630	9921630	9928480	9928480	9928480	9921630	9928480	9921630	9928480	9921630	9921630
		9928550	9928550	9928550		9928550		9928550		
9931710	9931710	9931710	9931710	9931710	9931710	9931710	9931710	9931710	9931710	9931710
9930830	9930830	9930830	9930830	9930830	9930830	9930830	9930830	9930830	9930830	9930830
		9926580	9926580	9926580		9926580		9926580		
		9926560	9926560	9926560		9926560		9926560		
990875P	990875P	990875P	990875P	990875P	990875P	990875P	990875P	990875P	990875P	990875P
	9931440		9931440				9931440	9931440		9931440
		9930140	9930140	9930140		9930140		9930140		
9931620	9931620	9931620	9931620	9931620	9931620	9931620	9931620	9931620	9931620	9931620

SCOOTER 50cc RACING



Benelli	Benelli	Benelli	Benelli	Benelli	Benelli
Pepe	Pepe LX	Pepe LX	Pepe Old	Pepe Old	Quattronex
10-10	03-04	07-09	07-09	11-11	08-09
50cc 2T AC	50cc 2T AC	50cc 2T AC	50cc 2T AC	50cc 2T AC	50cc 2T AC
Tipo Keeway	MY	Tipo Keeway	Tipo Keeway	Tipo Keeway	Tipo Keeway

ALBERO MOTORE TPR CORSA STD		Spinotto Ø 10		9925910				
		Spinotto Ø 12		9928320				
COPERCHIO INGRANAGGI				9930300				
COPERCHIO TRASMISSIONE				9930200				
CUSCINETTI DI BANCO TPR Carbonitrurati		Serie		9929190				
FRIZIONE TPR GP REGOLABILE Patented				9927450				
GRUPPO TERMICO RACING Maggiorato ghisa c/testa				9930030				
GRUPPO TERMICO RACING 2004 Maggiorato c/testa scomposta								
GRUPPO TRASFORMAZIONE DA ARIA AD ACQUA - Ghisa				9911210				
GRUPPO TERMICO TPR Maggiorato in alluminio		Spinotto Ø 10		9921630				
		Spinotto Ø 12						
KIT ASPIRAZIONE COMPLETO		OKO 28	9931710	9931710	9931710	9931710	9931710	9931710
		TM 24	9930830	9930830	9930830	9930830	9930830	9930830
MAXI KIT 77 CC ALESAGGIO Ø 50 CORSA STD								
MAXI KIT 86 CC ALESAGGIO Ø 50 CORSA 44 mm								
RAPPORTO ALLUNGATO				990875P				
SCARICO NARDÒ 2		Omologato						
SCARICO TPR GP								
VALVOLA LAMELLARE TPR			9931620	9931620	9931620	9931620	9931620	9931620

SCOOTER 50cc RACING

Benelli	Benelli	Beta	Beta	Beta	Beta	Beta	Beta	Beta	Beta	Beta
Quattronex	Quattronex	Ark	Ark LC	Chrono	Chrono	Eikon	Quadra	Quadra	Tempo	Tempo
10-10	11-11	96-08	96-08	96-96	-00	99-03	95-95	-00	95-95	-00
50cc 2T AC	50cc 2T AC	50cc 2T AC	50cc 2T LC	50cc 2T AC	50cc 2T AC	50cc 2T LC	50cc 2T AC	50cc 2T AC	50cc 2T AC	50cc 2T AC
Tipo Keeway	Tipo Keeway	MY	MA	MY	MY	MA	MY	MY	MY	MY
		9925910	9925910	9925910	9925910	9925910	9925910	9925910	9925910	9925910
		9928320	9928320	9928320	9928320	9928320	9928320	9928320	9928320	9928320
		9930300	9930300	9930300	9930300	9930300	9930300	9930300	9930300	9930300
		9930200	9930200	9930200	9930200	9930200	9930200	9930200	9930200	9930200
		9929190	9929190	9929190	9929190	9929190	9929190	9929190	9929190	9929190
		9927450	9927450	9927450	9927450	9927450	9927450		9927450	9927450
		9930030	9912800	9930030	9930030	9912800	9930030	9930030	9930030	9930030
			9921160			9921160				
		9911210		9911210	9911210		9911210	9911210	9911210	9911210
		9921630	9928480	9921630	9921630	9928480	9921630	9921630	9921630	9921630
			9928550			9928550				
9931710	9931710	9931710	9931710	9931710	9931710	9931710	9931710	9931710	9931710	9931710
9930830	9930830	9930830	9930830	9930830	9930830	9930830	9930830	9930830	9930830	9930830
			9926580			9926580				
			9926560			9926560				
		990875P	990875P	990875P	990875P	990875P	990875P	990875P	990875P	990875P
		9931440	9931440	9931440	9931440	9931440	9931440	9931440	9931440	9931440
			9930140			9930140				
9931620	9931620	9931620	9931620	9931620	9931620	9931620	9931620	9931620	9931620	9931620

SCOOTER 50cc RACING



CPI	CPI	CPI	CPI	Derbi	Derbi
Aragon	Hussar	Oliver	Pop Corn	Atlantis 2T	Atlantis 2T EU2
03-03	03-03	03-03	03-03	10-10	07-09
50cc 2T AC	50cc 2T AC	50cc 2T AC	50cc 2T AC	50cc 2T AC	50cc 2T AC
Tipo Keeway	Tipo Keeway	Tipo Keeway	Tipo Keeway	Motore Piaggio	Motore Piaggio

ALBERO MOTORE TPR CORSA STD		Spinotto Ø 10					
		Spinotto Ø 12				9926180	9926180
COPERCHIO INGRANAGGI							
COPERCHIO TRASMISSIONE							
CUSCINETTI DI BANCO TPR Carbonitrurati		Serie				9929200	9929200
FRIZIONE TPR GP REGOLABILE Patented						9928340	9928340
GRUPPO TERMICO RACING Maggiorato ghisa c/testa						9930060	9930060
GRUPPO TERMICO RACING 2004 Maggiorato c/testa scomposta							
GRUPPO TRASFORMAZIONE DA ARIA AD ACQUA - Ghisa							
GRUPPO TERMICO TPR Maggiorato in alluminio		Spinotto Ø 10					
		Spinotto Ø 12				9921550	9921550
KIT ASPIRAZIONE COMPLETO		OKO 28	9931710	9931710	9931710	9931710	9931730
		TM 24	9930830	9930830	9930830	9930830	9930870
MAXI KIT 77 CC ALESAGGIO Ø 50 CORSA STD							
MAXI KIT 86 CC ALESAGGIO Ø 50 CORSA 44 mm							
RAPPORTO ALLUNGATO							
SCARICO NARDÒ 2		Omologato				9931460	9931460
SCARICO TPR GP							
VALVOLA LAMELLARE TPR			9931620	9931620	9931620	9931620	9931640

SCOOTER 50cc RACING

Derbi	Derbi	Derbi	Derbi	Derbi	Derbi	Derbi	Derbi	Derbi	Derbi	Derbi
Atlantis 4T	Atlantis 4T EU2	Atlantis O2	Atlantis O2 Bullet	Atlantis O2 City	Atlantis O2 Red Bullet	Atlantis O2 Two Chic	Boulevard	Boulevard 4T EU2 25KM/H	GP1	GP1
04-06	07-07	02-02	03-05	03-06	03-03	05-05	09-12	-	01-02	03-03
50cc 4T AC	50cc 4T AC	50cc 2T AC	50cc 2T AC	50cc 2T AC	50cc 2T AC	50cc 2T AC	50cc 2T AC	50cc 4T AC	50cc 2T LC	50cc 2T LC
Motore Piaggio	Motore Piaggio	Motore Piaggio	Motore Piaggio	Motore Piaggio	Motore Piaggio	Motore Piaggio	Motore Piaggio	Motore Piaggio	Motore Piaggio	Motore Piaggio
		9926180	9926180	9926180	9926180	9926180	9926180		9926180	9926180
			9929200	9929200	9929200	9929200			9929200	9929200
9928340	9928340	9928340	9928340	9928340	9928340	9928340	9928340	9928340	9928340	9928340
		9930060	9930060	9930060	9930060	9930060	9930060		9920590	9920590
		9921550	9921550	9921550	9921550	9921550	9921550		9928520	9928520
		9931730	9931730	9931730	9931730	9931730	9931730		9931730	9931730
		9930870	9930870	9930870	9930870	9930870	9930870		9930870	9930870
									9928390	9928390
									9928440	9928440
		9931460	9931460	9931460	9931460	9931460	9931460		9931460	9931460
									9930160	9930160
		9931640	9931640	9931640	9931640	9931640	9931640		9931640	9931640

SCOOTER 50cc RACING



Derbi	Derbi	Derbi	Derbi	Explorer	Garelli
GP1 EU2	GP1 Open EU2	GP1 Race EU2	Sonar 2T	Cracker	GPS
05-05	06-09	05-07	09-09	03-03	09-11
50cc 2T LC	50cc 2T LC	50cc 2T LC	50cc 2T AC	50cc 2T AC	50cc 2T LC
Motore Piaggio	Motore Piaggio	Motore Piaggio	Motore Piaggio	Tipo Keeway	Tipo MA

ALBERO MOTORE TPR CORSA STD		Spinotto Ø 10						
		Spinotto Ø 12	9926180	9926180	9926180	9926180		
COPERCHIO INGRANAGGI								
COPERCHIO TRASMISSIONE								
CUSCINETTI DI BANCO TPR Carbonitrurati		Serie	9929200	9929200	9929200	9929200		
FRIZIONE TPR GP REGOLABILE Patented			9928340	9928340	9928340	9928340		
GRUPPO TERMICO RACING Maggiorato ghisa c/testa			9920590	9920590	9920590	9930060		
GRUPPO TERMICO RACING 2004 Maggiorato c/testa scomposta								
GRUPPO TRASFORMAZIONE DA ARIA AD ACQUA - Ghisa								
GRUPPO TERMICO TPR Maggiorato in alluminio		Spinotto Ø 10						
		Spinotto Ø 12	9928520	9928520	9928520	9921550		
KIT ASPIRAZIONE COMPLETO		OKO 28	9931730	9931730	9931730	9931730	9931710	9931710
		TM 24	9930870	9930870	9930870	9930870	9930830	9930830
MAXI KIT 77 CC ALESAGGIO Ø 50 CORSA STD			9928390	9928390	9928390			
MAXI KIT 86 CC ALESAGGIO Ø 50 CORSA 44 mm			9928440	9928440	9928440			
RAPPORTO ALLUNGATO								
SCARICO NARDÒ 2		Omologato	9931460	9931460	9931460	9931460		
SCARICO TPR GP			9930160	9930160	9930160			
VALVOLA LAMELLARE TPR			9931640	9931640	9931640	9931640	9931620	

SCOOTER 50cc RACING

Gilera	Gilera	Gilera	Gilera	Gilera	Gilera	Gilera	Gilera	Gilera	Gilera	Gilera
DNA	DNA	DNA GP Experience	Easy Moving	Ice	Runner	Runner Poggiali	Runner Pure Jet	Runner Pure Jet	Runner Pure Jet	Runner Pure Jet
00-02	05-07	03-04	95-96	01-05	97-00	02-02	02-04	05-06	07-07	10-11
50cc 2T LC	50cc 2T LC	50cc 2T LC	50cc 2T AC	50cc 2T AC	50cc 2T LC	50cc 2T LC	50cc 2T-IE LC	50cc 2T-IE LC	50cc 2T-IE LC	50cc 2T-IE LC
Motore Piaggio	Motore Piaggio	Motore Piaggio	Motore Piaggio	Motore Piaggio	Motore Piaggio	Motore Piaggio	Motore Piaggio	Motore Piaggio	Motore Piaggio	Motore Piaggio
9926180	9926180	9926180	9926180	9926180	9926180	9926180				
9929200	9929200	9929200	9929200	9929200	9929200	9929200	9929200	9929200	9929200	9929200
9928340	9928340	9928340	9928340	9928340	9928340	9928340	9928340	9928340	9928340	9928340
9920590	9920590	9920590	9930060	9930060	9920590	9920590				
9928520	9928520	9928520	9921550	9921550	9928520	9928520				
9931730	9931730	9931730	9931730	9931730	9931730	9931730				
9930870	9930870	9930870	9930870	9930870	9930870	9930870				
9928390	9928390	9928390			9928390	9928390				
9928440	9928440	9928440			9928440	9928440				
9931460	9931460	9931460	9931460	9931460	9931460	9931460	9931460	9931460	9931460	9931460
9930160	9930160	9930160			9930160	9930160				
9931640	9931640	9931640	9931640	9931640	9931640	9931640	9931640	9931640	9931640	9931640

SCOOTER 50cc RACING



Gilera	Gilera	Gilera	Gilera	Gilera	Gilera
Runner Pure Jet ST	Runner SP	Runner SP	Runner SP	Runner SP	Runner SP ST & Simoncelli
08-08	02-04	05-06	07-07	10-12	08-09
50cc 2T-IE LC	50cc 2T LC	50cc 2T LC	50cc 2T LC	50cc 2T LC	50cc 2T LC
Motore Piaggio	Motore Piaggio	Motore Piaggio	Motore Piaggio	Motore Piaggio	Motore Piaggio

ALBERO MOTORE TPR CORSA STD		Spinotto Ø 10						
		Spinotto Ø 12		9926180	9926180	9926180	9926180	9926180
COPERCHIO INGRANAGGI								
COPERCHIO TRASMISSIONE								
CUSCINETTI DI BANCO TPR Carbonitrurati		Serie	9929200	9929200	9929200	9929200	9929200	9929200
FRIZIONE TPR GP REGOLABILE Patented			9928340	9928340	9928340	9928340	9928340	9928340
GRUPPO TERMICO RACING Maggiorato ghisa c/testa				9920590	9920590	9920590	9920590	9920590
GRUPPO TERMICO RACING 2004 Maggiorato c/testa scomposta								
GRUPPO TRASFORMAZIONE DA ARIA AD ACQUA - Ghisa								
GRUPPO TERMICO TPR Maggiorato in alluminio		Spinotto Ø 10						
		Spinotto Ø 12		9928520	9928520	9928520	9928520	9928520
KIT ASPIRAZIONE COMPLETO		OKO 28		9931730	9931730	9931730	9931730	9931730
		TM 24		9930870	9930870	9930870	9930870	9930870
MAXI KIT 77 CC ALESAGGIO Ø 50 CORSA STD				9928390	9928390	9928390	9928390	9928390
MAXI KIT 86 CC ALESAGGIO Ø 50 CORSA 44 mm				9928440	9928440	9928440	9928440	9928440
RAPPORTO ALLUNGATO								
SCARICO NARDÒ 2		Omologato	9931460	9931460	9931460	9931460	9931460	9931460
SCARICO TPR GP				9930160	9930160	9930160	9930160	9930160
VALVOLA LAMELLARE TPR			9931640	9931640	9931640	9931640	9931640	9931640

SCOOTER 50cc RACING

Gilera	Gilera	Gilera	Gilera	Gilera	Gilera	Gilera	Gilera	Gilera	Gilera	Gilera
Runner SP Special Edition	Stalker	Stalker	Stalker	Stalker	Stalker Naked	Stalker Special Edition	Storm	Storm Euro 2	Typhoon	Typhoon X
07-07	97-04	05-06	07-08	09-11	08-08	07-08	94-95	07-07	94-97	98-99
50cc 2T LC	50cc 2T AC	50cc 2T AC	50cc 2T AC	50cc 2T AC	50cc 2T AC	50cc 2T AC	50cc 2T AC	50cc 2T AC	50cc 2T AC	50cc 2T AC
Motore Piaggio	Motore Piaggio	Motore Piaggio	Motore Piaggio	Motore Piaggio	Motore Piaggio	Motore Piaggio	Motore Piaggio	Motore Piaggio	Motore Piaggio	Motore Piaggio
9926180	9926180	9926180	9926180	9926180	9926180	9926180	9926180	9926180	9926180	9926180
9929200	9929200	9929200	9929200	9929200	9929200	9929200	9929200	9929200	9929200	9929200
9928340	9928340	9928340	9928340	9928340	9928340	9928340	9928340	9928340	9928340	9928340
9920590	9930060	9930060	9930060	9930060	9930060	9930060	9930060	9930060	9930060	9930060
9928520	9921550	9921550	9921550	9921550	9921550	9921550	9921550	9921550	9921550	9921550
9931730	9931730	9931730	9931730	9931730	9931730	9931730	9931730	9931730	9931730	9931730
9930870	9930870	9930870	9930870	9930870	9930870	9930870	9930870	9930870	9930870	9930870
9928390										
9928440										
9931460	9931460	9931460	9931460	9931460	9931460	9931460	9931460	9931460	9931460	9931460
9930160										
9931640	9931640	9931640	9931640	9931640	9931640	9931640	9931640	9931640	9931640	9931640

SCOOTER 50cc RACING



Gilera	Italjet	Italjet	Italjet	Italjet	Italjet
Typhoon XR	Bazooka	Dragster	Jet Set	Pista	Pista 2
00-00	-00	-00	-00	-00	-00
50cc 2T AC	50cc 2T AC	50cc 2T LC	50cc 2T AC	50cc 2T AC	50cc 2T AC
Motore Piaggio	Tipo CW	MA	Motore Piaggio	Tipo CW	Tipo CW

ALBERO MOTORE TPR CORSA STD		Spinotto Ø 10			9925910			
		Spinotto Ø 12	9926180		9928320	9926180		
COPERCHIO INGRANAGGI					9930300			
COPERCHIO TRASMISSIONE					9930200			
CUSCINETTI DI BANCO TPR Carbonitrurati		Serie	9929200		9929190	9929200		
FRIZIONE TPR GP REGOLABILE Patented			9928340	9927450	9927450	9928340	9927450	9927450
GRUPPO TERMICO RACING Maggiorato ghisa c/testa			9930060		9912800	9930060		
GRUPPO TERMICO RACING 2004 Maggiorato c/testa scomposta					9921160			
GRUPPO TRASFORMAZIONE DA ARIA AD ACQUA - Ghisa								
GRUPPO TERMICO TPR Maggiorato in alluminio		Spinotto Ø 10			9928480			
		Spinotto Ø 12	9921550		9928550	9921550		
KIT ASPIRAZIONE COMPLETO		OKO 28	9931730		9931710	9931730		
		TM 24	9930870		9930830	9930870		
MAXI KIT 77 CC ALESAGGIO Ø 50 CORSA STD					9926580			
MAXI KIT 86 CC ALESAGGIO Ø 50 CORSA 44 mm					9926560			
RAPPORTO ALLUNGATO					990875P			
SCARICO NARDÒ 2		Omologato	9931460	9931450	9931440	9931460	9931450	9931450
SCARICO TPR GP					9930140			
VALVOLA LAMELLARE TPR			9931640		9931620	9931640		

SCOOTER 50cc RACING

Italjet	Italjet	Italjet	Italjet	Italjet	KTM	Keeway	Keeway	Keeway	Keeway	Keeway
Scoop	Scoop 2	Torpedo	Torpedo New	Yankee	K50	F-Act	Flash	Focus	Goccia	Hurricane
-00	-00	-00	-00	-00	-00	07-08	07-08	06-06	09-09	06-08
50cc 2T AC	50cc 2T AC	50cc 4T AC	50cc 2T AC	50cc 2T AC	50cc 2T AC	50cc 2T AC	50cc 2T AC	50cc 2T AC	50cc 2T AC	50cc 2T AC
Tipo CW	Tipo CW	Motore Piaggio	Motore Piaggio	Tipo CW	MY	Motore Keeway	Motore Keeway	Motore Keeway	Motore Keeway	Motore Keeway
					9925910					
			9926180		9928320					
					9930300					
					9930200					
			9929200		9929190					
9927450	9927450	9928340	9928340	9927450	9927450					
			9930060		9930030					
					9911210					
					9921630					
			9921550							
			9931730		9931710	9931710	9931710	9931710	9931710	9931710
			9930870		9930830	9930830	9930830	9930830	9930830	9930830
					990875P					
9931450	9931450		9931460	9931450						
			9931640		9931620	9931620	9931620	9931620	9931620	9931620

SCOOTER 50cc RACING



Keeway	Keeway	Keeway	Macal	Macal	Malaguti
Matrix	Pixel Euro 2	RY8	Sting	Thunder	Centro
06-08	-00	08-08	-00	-00	-00
50cc 2T AC	50cc 2T AC	50cc 2T AC	50cc 2T AC	50cc 2T AC	50cc 2T AC
Motore Keeway	Motore Keeway	Motore Keeway	CY	MY	MY

ALBERO MOTORE TPR CORSA STD		Spinotto Ø 10				9925910	9925910
		Spinotto Ø 12				9928320	9928320
COPERCHIO INGRANAGGI						9930300	9930300
COPERCHIO TRASMISSIONE						9930200	9930200
CUSCINETTI DI BANCO TPR Carbonitrurati		Serie			9929190	9929190	9929190
FRIZIONE TPR GP REGOLABILE Patented						9927450	9927450
GRUPPO TERMICO RACING Maggiorato ghisa c/testa					9930030	9930030	9930030
GRUPPO TERMICO RACING 2004 Maggiorato c/testa scomposta							
GRUPPO TRASFORMAZIONE DA ARIA AD ACQUA - Ghisa						9911210	9911210
GRUPPO TERMICO TPR Maggiorato in alluminio		Spinotto Ø 10				9921630	9921630
		Spinotto Ø 12					
KIT ASPIRAZIONE COMPLETO		OKO 28	9931710	9931710	9931710	9931710	9931710
		TM 24	9930830	9930830	9930830	9930830	9930830
MAXI KIT 77 CC ALESAGGIO Ø 50 CORSA STD							
MAXI KIT 86 CC ALESAGGIO Ø 50 CORSA 44 mm							
RAPPORTO ALLUNGATO					990902P	990875P	990875P
SCARICO NARDÒ 2		Omologato					9931440
SCARICO TPR GP							
VALVOLA LAMELLARE TPR			9931620	9931620	9931620	9931620	9931620

SCOOTER 50cc RACING

Malaguti	Malaguti	Malaguti	Malaguti	Malaguti	Malaguti	Malaguti	Malaguti	Malaguti	Malaguti	Malaguti
Centro Euro 2	Centro SL 4T	Ciak	Ciak Euro 2 2,3	Ciak Euro2	Ciak Master 4T	Ciak Master Euro 2	Ciak Master Euro 2	F10	F10 Euro 2	F10 Euro 2 2,3
08-08	10-10	-00	03-03	01-03	05-06	05-06	06-06	-00	-00	03-04
50cc 4T AC	50cc 4T AC	50cc 2T AC	50cc 2T AC	50cc 2T AC	50cc 4T AC	50cc 4T AC	50cc 2T AC	50cc 2T AC	50cc 2T AC	50cc 2T AC
Motore Piaggio	Motore Piaggio	MY	MY	MY	Motore Piaggio	Motore Piaggio	MY	CY	CY	CY
		9925910	9925910	9925910			9925910	9925910	9925910	9925910
		9928320	9928320	9928320			9928320	9928320	9928320	9928320
		9930300	9930300	9930300			9930300			
		9930200	9930200	9930200			9930200			
		9929190	9929190	9929190			9929190	9929190	9929190	9929190
9928340	9928340	9927450	9927450	9927450	9928340	9928340		9927450	9927450	9927450
		9930030	9930030	9930030			9930030	9930030	9930030	9930030
		9911210	9911210	9911210			9911210	9911210	9911210	9911210
		9921630	9921630	9921630			9921630	9921630	9921630	9921630
		9931710	9931710	9931710			9931710	9931710	9931710	9931710
		9930830	9930830	9930830			9930830	9930830	9930830	9930830
								990902P	990902P	990902P
		9931440	9931440	9931440			9931440	9931440	9931440	9931440
		9931620	9931620	9931620			9931620	9931620	9931620	9931620

SCOOTER 50cc RACING



Malaguti	Malaguti	Malaguti	Malaguti	Malaguti	Malaguti
F10 Restyling Euro 2	F10 Wap Euro 2	F12 Phantom	F12 Phantom Euro 2	F12 Phantom Euro 2,2,3	F12 Phantom LC
06-06	-00	-00	02-02	03-04	-00
50cc 2T AC	50cc 2T AC	50cc 2T AC	50cc 2T LC	50cc 2T AC	50cc 2T LC
CY	Tipo Keeway	MY	MA vent.	MY	MA

ALBERO MOTORE TPR CORSA STD 	Spinotto Ø 10	9925910		9925910		9925910	9925910
	Spinotto Ø 12	9928320		9928320		9928320	9928320
COPERCHIO INGRANAGGI 				9930300	9930300	9930300	9930300
COPERCHIO TRASMISSIONE 				9930200		9930200	9930200
CUSCINETTI DI BANCO TPR Carbonitrurati 	Serie	9929190		9929190	9929190	9929190	9929190
FRIZIONE TPR GP REGOLABILE Patented 				9927450	9927450	9927450	9927450
GRUPPO TERMICO RACING Maggiorato ghisa c/testa 		9930030		9930030	9912800	9930030	9912800
GRUPPO TERMICO RACING 2004 Maggiorato c/testa scomposta 					9921160		9921160
GRUPPO TRASFORMAZIONE DA ARIA AD ACQUA - Ghisa 		9911210		9911210		9911210	
GRUPPO TERMICO TPR Maggiorato in alluminio 	Spinotto Ø 10	9921630		9921630	9928480	9921630	9928480
	Spinotto Ø 12				9928550		9928550
KIT ASPIRAZIONE COMPLETO 	OKO 28	9931710	9931710	9931710	9931710	9931710	9931710
	TM 24	9930830	9930830	9930830	9930830	9930830	9930830
MAXI KIT 77 CC ALESAGGIO Ø 50 CORSA STD 							9926580
MAXI KIT 86 CC ALESAGGIO Ø 50 CORSA 44 mm 							9926560
RAPPORTO ALLUNGATO 		990902P		990875P	990875P	990875P	990875P
SCARICO NARDÒ 2 	Omologato	9931440		9931440		9931440	9931440
SCARICO TPR GP 							9930140
VALVOLA LAMELLARE TPR 		9931620	9931620	9931620	9931620	9931620	9931620

SCOOTER 50cc RACING

Malaguti	Malaguti	Malaguti	Malaguti	Malaguti	Malaguti	Malaguti	Malaguti	Malaguti	Malaguti	Malaguti
F12 Phantom LC Euro 2,2,3	F12 R Phantom	F12 R Phantom LC	F12 Restyling Euro 1	F12 Restyling Euro 2	F12 Restyling LC Euro 2	F15 Firefox	F15 Firefox Euro 2	F15 Firefox Euro 2	F15 Firefox Euro 2	F15 Firefox Euro 2,2,3
03-04	07-07	07-09	99-02	06-06	06-06	-00	02-03	04-06	05-06	03-04
50cc 2T LC	50cc 2T AC	50cc 2T LC	50cc 2T LC	50cc 2T AC	50cc 2T LC	50cc 2T LC	50cc 2T LC	50cc 2T LC	50cc 2T AC	50cc 2T LC
MA vent.	Tipo Keeway	MA	MA vent.	MY	MA vent.	MA	MA	MA	MY	MA
		9925910		9925910		9925910	9925910	9925910	9925910	9925910
		9928320		9928320		9928320	9928320	9928320	9928320	9928320
9930300		9930300	9930300	9930300	9930300	9930300	9930300	9930300	9930300	9930300
		9930200		9930200		9930200	9930200	9930200	9930200	9930200
9929190		9929190	9929190	9929190	9929190	9929190	9929190	9929190	9929190	9929190
9927450			9927450	9927450		9927450	9927450			9927450
9912800		9912800	9912800	9930030	9912800	9912800	9912800	9912800	9930030	9912800
9921160		9921160	9921160		9921160	9921160	9921160	9921160		9921160
				9911210					9911210	
9928480		9928480	9928480	9921630	9928480	9928480	9928480	9928480	9921630	9928480
9928550		9928550	9928550		9928550	9928550	9928550	9928550		9928550
9931710	9931710	9931710	9931710	9931710	9931710	9931710	9931710	9931710	9931710	9931710
9930830	9930830	9930830	9930830	9930830	9930830	9930830	9930830	9930830	9930830	9930830
		9926580				9926580	9926580	9926580		9926580
		9926560				9926560	9926560	9926560		9926560
990875P		990875P	990875P	990875P	990875P	990875P	990875P	990875P	990875P	990875P
		9931440		9931440		9931440	9931440	9931440	9931440	9931440
		9930140				9930140	9930140	9930140		9930140
9931620	9931620	9931620	9931620	9931620	9931620	9931620	9931620	9931620	9931620	9931620

SCOOTER 50cc RACING



	Malaguti	Mbk	Mbk	Mbk	Mbk	Mbk
	Yesterday	Booster	Booster Euro 2	Booster NG	Booster NG	Booster Rocket
	97-00	-00	04-04	03-03	-00	97-98
	50cc 2T AC	50cc 2T AC	50cc 2T AC	50cc 2T AC	50cc 2T AC	50cc 2T AC
	CY	CW	CW	CW	CW	CW

ALBERO MOTORE TPR CORSA STD 	Spinotto Ø 10	9925910	9927900	9927900	9927900	9927900	9927900
	Spinotto Ø 12	9928320					
COPERCHIO INGRANAGGI 			9930300	9930300	9930300	9930300	9930300
COPERCHIO TRASMISSIONE 							
CUSCINETTI DI BANCO TPR Carbonitrurati 	Serie	9929190	9929190	9929190	9929190	9929190	9929190
FRIZIONE TPR GP REGOLABILE Patented 		9927450	9927450	9927450	9927450	9927450	9927450
GRUPPO TERMICO RACING Maggiorato ghisa c/testa 		9930030	9930000	9930000	9930000	9930000	9930000
GRUPPO TERMICO RACING 2004 Maggiorato c/testa scomposta 							
GRUPPO TRASFORMAZIONE DA ARIA AD ACQUA - Ghisa 		9911210					
GRUPPO TERMICO TPR Maggiorato in alluminio 	Spinotto Ø 10	9921630	9921640	9921640	9921640	9921640	9921640
	Spinotto Ø 12						
KIT ASPIRAZIONE COMPLETO 	OKO 28	9931710					
	TM 24	9930830					
MAXI KIT 77 CC ALESAGGIO Ø 50 CORSA STD 							
MAXI KIT 86 CC ALESAGGIO Ø 50 CORSA 44 mm 							
RAPPORTO ALLUNGATO 		990902P	990875P	990875P	990875P	990875P	990875P
SCARICO NARDÒ 2 	Omologato	9931440	9931450		9931450	9931450	
SCARICO TPR GP 							
VALVOLA LAMELLARE TPR 		9931620					

SCOOTER 50cc RACING

Mbk	Mbk	Mbk	Mbk	Mbk	Mbk	Mbk	Mbk	Mbk	Mbk	Mbk
Booster Spirit	Booster Spirit	Booster Track	Booster X ie	Evolis	Fizz	Flipper	Flipper Euro 2	Forte	Mach G	Mach G LC
03-03	-00	96-98	08-08	92-95	94-95	-00	03-03	94-96	02-04	02-04
50cc 2T AC	50cc 2T AC	50cc 2T AC	50cc 4T-3V LC	50cc 2T AC	50cc 2T AC	50cc 2T AC	50cc 2T AC	50cc 2T AC	50cc 2T AC	50cc 2T LC
CW	CW	CW	15P1	CY	CY	MY	MY	CY	MY	MA
9927900	9927900	9927900		9925910	9925910	9925910	9925910	9925910	9925910	9925910
				9928320	9928320	9928320	9928320	9928320	9928320	9928320
9930300	9930300	9930300				9930300	9930300		9930300	9930300
						9930200	9930200		9930200	9930200
9929190	9929190	9929190		9929190	9929190	9929190	9929190	9929190	9929190	9929190
9927450	9927450	9927450					9927450		9927450	9927450
9930000	9930000	9930000		9930030	9930030	9930030	9930030	9930030	9930030	9912800
										9921160
				9911210	9911210	9911210	9911210	9911210	9911210	
9921640	9921640	9921640	9926330	9921630	9921630	9921630	9921630	9921630	9921630	9928480
										9928550
				9931710	9931710	9931710	9931710	9931710	9931710	9931710
				9930830	9930830	9930830	9930830	9930830	9930830	9930830
										9926580
										9926560
990875P	990875P	990875P		990902P	990902P			990902P	990875P	990875P
	9931450	9931450		9931440	9931440	9931440	9931440	9931440	9931440	9931440
										9930140
				9931620	9931620	9931620	9931620	9931620	9931620	9931620

SCOOTER 50cc RACING



Mbk	Mbk	Mbk	Mbk	Mbk	Mbk
Nitro	Nitro Euro 2	Ovetto	Ovetto 4T	Ovetto Euro 2	Sorriso
-00	03-03	-00	09-11	02-02	95-96
50cc 2T LC	50cc 2T LC	50cc 2T AC	50cc 4T-3V LC	50cc 2T AC	50cc 2T AC
MA	MA	MY	5C3	MY	Tipo CW

ALBERO MOTORE TPR CORSA STD		Spinotto Ø 10	9925910	9925910	9925910		9925910	
		Spinotto Ø 12	9928320	9928320	9928320		9928320	
COPERCHIO INGRANAGGI			9930300	9930300	9930300		9930300	
COPERCHIO TRASMISSIONE			9930200	9930200	9930200		9930200	
CUSCINETTI DI BANCO TPR Carbonitrurati		Serie	9929190	9929190	9929190		9929190	
FRIZIONE TPR GP REGOLABILE Patented			9927450	9927450	9927450		9927450	9927450
GRUPPO TERMICO RACING Maggiorato ghisa c/testa			9912800	9912800	9930030		9930030	
GRUPPO TERMICO RACING 2004 Maggiorato c/testa scomposta			9921160	9921160				
GRUPPO TRASFORMAZIONE DA ARIA AD ACQUA - Ghisa					9911210		9911210	
GRUPPO TERMICO TPR Maggiorato in alluminio		Spinotto Ø 10	9928480	9928480	9921630	9926330	9921630	
		Spinotto Ø 12	9928550	9928550				
KIT ASPIRAZIONE COMPLETO		OKO 28	9931710	9931710	9931710		9931710	
		TM 24	9930830	9930830	9930830		9930830	
MAXI KIT 77 CC ALESAGGIO Ø 50 CORSA STD			9926580	9926580				
MAXI KIT 86 CC ALESAGGIO Ø 50 CORSA 44 mm			9926560	9926560				
RAPPORTO ALLUNGATO			990875P	990875P	990875P		990875P	
SCARICO NARDÒ 2		Omologato	9931440	9931440	9931440		9931440	
SCARICO TPR GP			9930140	9930140				
VALVOLA LAMELLARE TPR			9931620	9931620	9931620		9931620	

SCOOTER 50cc RACING

Mbk	Mbk	Motron	Motron	Motron	PGO	Piaggio	Piaggio	Piaggio	Piaggio	Piaggio
Stunt	Target	Sting	Syncro	Thunder	Big Max	Diesis	Fly 2T	Fly 2T	Fly 4T	Fly 4T & 25-30 KM/H
00-02	91-95	-00	-00	-00	-00	01-01	05-07	10-11	05-07	08-11
50cc 2T AC	50cc 2T AC	50cc 2T AC	50cc 2T AC	50cc 2T AC	50cc 2T AC	50cc 2T AC	50cc 2T AC	50cc 2T AC	50cc 4T AC	50cc 4T AC
CW	Tipo CW	CY	MY	MY	Tipo MY	Motore Piaggio	Motore Piaggio	Motore Piaggio	Motore Piaggio	Motore Piaggio
9927900			9925910	9925910						
			9928320	9928320		9926180	9926180	9926180		
9930300			9930300	9930300						
			9930200	9930200						
9929190		9929190	9929190	9929190	9929190	9929200	9929200	9929200		
9927450	9927450		9927450	9927450		9928340	9928340	9928340	9928340	9928340
9930000		9930030	9930030	9930030	9930030	9930060	9930060	9930060		
			9911210	9911210						
9921640			9921630	9921630	9921630					
						9921550	9921550	9921550		
		9931710	9931710	9931710	9931710	9931730	9931730	9931730		
		9930830	9930830	9930830	9930830	9930870	9930870	9930870		
990875P		990902P	990875P	990875P						
9931450						9931460	9931460	9931460		
			9931620	9931620		9931640	9931640	9931640		

SCOOTER 50cc RACING



Piaggio	Piaggio	Piaggio	Piaggio	Piaggio	Piaggio
Fly 4T 4V	Fly 4T Motore CHN	Free	Free Delivery	Free FL	Liberty
12-12	06-07	92-94	00-01	95-02	97-05
50cc 4T-4V AC	50cc 4T AC	50cc 2T AC	50cc 2T AC	50cc 2T AC	50cc 2T AC
Motore Piaggio	Motore Piaggio	Motore Piaggio	Motore Piaggio	Motore Piaggio	Motore Piaggio

ALBERO MOTORE TPR CORSA STD		Spinotto Ø 10					
		Spinotto Ø 12		9926180	9926180	9926180	9926180
COPERCHIO INGRANAGGI							
COPERCHIO TRASMISSIONE							
CUSCINETTI DI BANCO TPR Carbonitrurati		Serie		9929200	9929200	9929200	9929200
FRIZIONE TPR GP REGOLABILE Patented			9928340	9928340	9928340	9928340	9928340
GRUPPO TERMICO RACING Maggiorato ghisa c/testa				9930060	9930060	9930060	9930060
GRUPPO TERMICO RACING 2004 Maggiorato c/testa scomposta							
GRUPPO TRASFORMAZIONE DA ARIA AD ACQUA - Ghisa							
GRUPPO TERMICO TPR Maggiorato in alluminio		Spinotto Ø 10					
		Spinotto Ø 12		9921550	9921550	9921550	9921550
KIT ASPIRAZIONE COMPLETO		OKO 28		9931730	9931730	9931730	9931730
		TM 24		9930870	9930870	9930870	9930870
MAXI KIT 77 CC ALESAGGIO Ø 50 CORSA STD							
MAXI KIT 86 CC ALESAGGIO Ø 50 CORSA 44 mm							
RAPPORTO ALLUNGATO							
SCARICO NARDÒ 2		Omologato		9931460	9931460	9931460	9931460
SCARICO TPR GP							
VALVOLA LAMELLARE TPR				9931640	9931640	9931640	9931640

SCOOTER 50cc RACING

Piaggio	Piaggio	Piaggio	Piaggio	Piaggio	Piaggio	Piaggio	Piaggio	Piaggio	Piaggio	Piaggio
Liberty 2T	Liberty 2T	Liberty 2T PTT EU2	Liberty 2T RST	Liberty 2T Sport	Liberty 2T Sport	Liberty 4T	Liberty 4T	Liberty 4T De- livery - Single	Liberty 4T Delivery TNT	Liberty 4T PTT - DOUBLE
06-06	07-08	04-05	04-04	06-06	07-08	00-02	05-08	10-12	09-09	09-12
50cc 2T AC	50cc 2T AC	50cc 2T AC	50cc 2T AC	50cc 2T AC	50cc 2T AC	50cc 4T AC	50cc 4T AC	50cc 4T AC	50cc 4T AC	50cc 4T AC
Motore Piaggio	Motore Piaggio	Motore Piaggio	Motore Piaggio	Motore Piaggio	Motore Piaggio	Motore Piaggio	Motore Piaggio	Motore Piaggio	Motore Piaggio	Motore Piaggio
9926180	9926180	9926180	9926180	9926180	9926180					
9929200	9929200	9929200	9929200	9929200	9929200					
9928340	9928340	9928340	9928340	9928340	9928340	9928340	9928340	9928340	9928340	9928340
9930060	9930060	9930060	9930060	9930060	9930060					
9921550	9921550	9921550	9921550	9921550	9921550					
9931730	9931730	9931730	9931730	9931730	9931730					
9930870	9930870	9930870	9930870	9930870	9930870					
9931460	9931460	9931460	9931460	9931460	9931460					
9931640	9931640	9931640	9931640	9931640	9931640					

SCOOTER 50cc RACING



Piaggio	Piaggio	Piaggio	Piaggio	Piaggio	Piaggio
Liberty 4T RST	Liberty 4T Sport	Liberty 4T Sport	Liberty MOC 2T & Elle	Liberty MOC 4T & Elle	NRG
04-04	06-06	07-08	-	09-13	94-96
50cc 4T AC	50cc 4T AC	50cc 4T AC	50cc 2T AC	50cc 4T AC	50cc 2T LC
Motore Piaggio	Motore Piaggio	Motore Piaggio	Motore Piaggio	Motore Piaggio	Motore Piaggio

ALBERO MOTORE TPR CORSA STD		Spinotto Ø 10					
		Spinotto Ø 12				9926180	9926180
COPERCHIO INGRANAGGI							
COPERCHIO TRASMISSIONE							
CUSCINETTI DI BANCO TPR Carbonitrurati		Serie				9929200	9929200
FRIZIONE TPR GP REGOLABILE Patented			9928340	9928340	9928340	9928340	9928340
GRUPPO TERMICO RACING Maggiorato ghisa c/testa						9930060	9920590
GRUPPO TERMICO RACING 2004 Maggiorato c/testa scomposta							
GRUPPO TRASFORMAZIONE DA ARIA AD ACQUA - Ghisa							
GRUPPO TERMICO TPR Maggiorato in alluminio		Spinotto Ø 10					
		Spinotto Ø 12				9921550	9928520
KIT ASPIRAZIONE COMPLETO		OKO 28				9931730	9931730
		TM 24				9930870	9930870
MAXI KIT 77 CC ALESAGGIO Ø 50 CORSA STD							9928390
MAXI KIT 86 CC ALESAGGIO Ø 50 CORSA 44 mm							9928440
RAPPORTO ALLUNGATO							
SCARICO NARDÒ 2		Omologato				9931460	9931460
SCARICO TPR GP							9930160
VALVOLA LAMELLARE TPR						9931640	9931640



SCOOTER 50cc RACING

Piaggio	Piaggio	Piaggio	Piaggio	Piaggio	Piaggio	Piaggio	Piaggio	Piaggio	Piaggio	Piaggio
NRG Extreme	NRG MC3	NRG Power DD	NRG Power DD	NRG Power DD	NRG Power DD Serie Speciale	NRG Power DT	NRG Power DT	NRG Power DT Serie Speciale	NRG Power Pure Jet	NRG Power PureJet
99-00	01-04	05-05	06-06	07-13	-	06-06	07-11	07-08	04-05	06-06
50cc 2T LC	50cc 2T LC	50cc 2T LC	50cc 2T LC	50cc 2T LC	50cc 2T LC	50cc 2T AC	50cc 2T AC	50cc 2T AC	50cc 2T-IE LC	50cc 2T-IE LC
Motore Piaggio	Motore Piaggio	Motore Piaggio	Motore Piaggio	Motore Piaggio	Motore Piaggio	Motore Piaggio	Motore Piaggio	Motore Piaggio	Motore Piaggio	Motore Piaggio
9926180	9926180	9926180	9926180	9926180	9926180	9926180	9926180	9926180		
9929200	9929200	9929200	9929200	9929200	9929200	9929200	9929200	9929200	9929200	9929200
9928340	9928340	9928340	9928340	9928340	9928340	9928340	9928340	9928340	9928340	9928340
9920590	9920590	9920590	9920590	9920590	9920590	9930060	9930060	9930060		
9928520	9928520	9928520	9928520	9928520	9928520	9921550	9921550	9921550		
9931730	9931730	9931730	9931730	9931730	9931730	9931730	9931730	9931730	9931730	9931730
9930870	9930870	9930870	9930870	9930870	9930870	9930870	9930870	9930870	9930870	9930870
9928390	9928390	9928390	9928390	9928390	9928390					
9928440	9928440	9928440	9928440	9928440	9928440					
9931460	9931460	9931460	9931460	9931460	9931460	9931460	9931460	9931460	9931460	9931460
9930160	9930160	9930160	9930160	9930160	9930160					
9931640	9931640	9931640	9931640	9931640	9931640	9931640	9931640	9931640	9931640	9931640

SCOOTER 50cc RACING



Piaggio	Piaggio	Piaggio	Piaggio	Piaggio	Piaggio
NRG Power PureJet	NRG Power PureJet	NRG PureJet	NRG PureJet	NRG RST MC2	NTT
07-09	10-11	02-04	10-10	96-98	95-96
50cc 2T-IE LC	50cc 2T-IE LC	50cc 2T-IE LC	50cc 2T-IE LC	50cc 2T LC	50cc 2T LC
Motore Piaggio	Motore Piaggio	Motore Piaggio	Motore Piaggio	Motore Piaggio	Motore Piaggio

ALBERO MOTORE TPR CORSA STD		Spinotto Ø 10						
		Spinotto Ø 12					9926180	9926180
COPERCHIO INGRANAGGI								
COPERCHIO TRASMISSIONE								
CUSCINETTI DI BANCO TPR Carbonitrurati		Serie	9929200	9929200	9929200	9929200	9929200	9929200
FRIZIONE TPR GP REGOLABILE Patented			9928340	9928340	9928340	9928340	9928340	9928340
GRUPPO TERMICO RACING Maggiorato ghisa c/testa							9920590	9920590
GRUPPO TERMICO RACING 2004 Maggiorato c/testa scomposta								
GRUPPO TRASFORMAZIONE DA ARIA AD ACQUA - Ghisa								
GRUPPO TERMICO TPR Maggiorato in alluminio		Spinotto Ø 10						
		Spinotto Ø 12					9928520	9928520
KIT ASPIRAZIONE COMPLETO		OKO 28	9931730	9931730	9931730	9931730	9931730	9931730
		TM 24	9930870	9930870	9930870	9930870	9930870	9930870
MAXI KIT 77 CC ALESAGGIO Ø 50 CORSA STD							9928390	9928390
MAXI KIT 86 CC ALESAGGIO Ø 50 CORSA 44 mm							9928440	9928440
RAPPORTO ALLUNGATO								
SCARICO NARDÒ 2		Omologato	9931460	9931460	9931460	9931460	9931460	9931460
SCARICO TPR GP							9930160	9930160
VALVOLA LAMELLARE TPR			9931640	9931640	9931640	9931640	9931640	9931640

SCOOTER 50cc RACING

Piaggio	Piaggio	Piaggio	Piaggio	Piaggio	Piaggio	Piaggio	Piaggio	Piaggio	Piaggio	Piaggio
Quartz	Sfera	Sfera Maquillage 2	Sfera RST	Typhoon	Typhoon	Typhoon	Typhoon 2T E2	Typhoon 2T E3 CH	Vespa ET2	Vespa ET2 iniezione
92-96	91-93	94-94	95-97	01-04	05-08	09-11	10-12	11-11	97-05	97-00
50cc 2T LC	50cc 2T AC	50cc 2T AC	50cc 2T AC	50cc 2T AC	50cc 2T AC	50cc 2T AC	50cc 2T AC	50cc 2T AC	50cc 2T AC	50cc 2T AC
Motore Piaggio	Motore Piaggio	Motore Piaggio	Motore Piaggio	Motore Piaggio	Motore Piaggio	Motore Piaggio	Motore Piaggio	Motore Piaggio	Motore Piaggio	Motore Piaggio
9926180	9926180	9926180	9926180	9926180	9926180	9926180	9926180	9926180	9926180	9926180
9929200	9929200	9929200	9929200	9929200	9929200	9929200	9929200	9929200	9929200	9929200
9928340	9928340	9928340	9928340	9928340	9928340	9928340	9928340	9928340	9928340	9928340
9920590	9930060	9930060	9930060	9930060	9930060	9930060	9930060	9930060	9930060	9930060
9928520	9921550	9921550	9921550	9921550	9921550	9921550	9921550	9921550	9921550	9921550
9931730	9931730	9931730	9931730	9931730	9931730	9931730	9931730	9931730	9931730	9931730
9930870	9930870	9930870	9930870	9930870	9930870	9930870	9930870	9930870	9930870	9930870
9928390										
9928440										
9931460	9931460	9931460	9931460	9931460	9931460	9931460	9931460	9931460	9931460	9931460
9930160										
9931640	9931640	9931640	9931640	9931640	9931640	9931640	9931640	9931640	9931640	9931640

MAXI SCOOTER



Aprilia	Aprilia	Aprilia	Aprilia	Aprilia	Aprilia
Scarabeo 100	Scarabeo 100	Atlantic 125	Atlantic 125 EU3	Atlantic 125 EU3	Atlantic 200
00-00	00-00	03-05	06-08	10-12	03-05
100cc 2T AC	100cc 2T AC	125cc 4T LC	125cc 4T LC	125cc 4T LC	200cc 4T LC
Minarelli	Yamaha		Piaggio	Piaggio	Piaggio M234M

ALBERO A CAMME							
ALBERO MOTORE		Sel. 1			IM070701	IM070701	
		Sel. 2			IM070702	IM070702	
BIELLA							
CAMPANA FRIZIONE				FZ00377	FZ00395	FZ00395	
CINGHIA DI TRASMISSIONE		Bando					
		Mitsuboshi	9935200	9935200	9927650	9927650	9927650
		Altro					
COLLETTORE ASPIRAZIONE				CT00734		CT00734	
FILTRO OLIO				FO07515	FO07515	FO07515	
FRIZIONE				FZ00396	FZ00396	FZ00396	
GRUPPO TERMICO		Standard					
		Maggiorato					
KIT CUSCINETTI/PARAOLI DI BANCO		Serie					
KIT REVISIONE POMPA ACQUA				AA00817	AA00826	AA00826	
MASSE CENTRIFUGHE PESO ORIGINALE						9932790	
MEMBRANA CARBURATORE		Tipo originale					
		Adattabile					
MOLLA CONTRASTO VARIATORE							
MOTORINO D'AVVIAMENTO				MA00012	MA00012	MA00012	
REGOLATORE DI TENSIONE				RE00011	RE00011	RE00011	
RUOTA LIBERA		Complete					
		RL + flangia			RL00041		
		RL nuda					
		Ingranaggio			RL00022	RL00022	RL00022
		Flangia					
SERIE DISCHI FRIZIONE							
STATORE					ST00023		
VARIATORE VARIOTOP TPR				9923600	9923600	9923600	

MAXI SCOOTER

Aprilia	Aprilia	Aprilia	Aprilia	Aprilia	Aprilia	Aprilia	Aprilia	Aprilia	Aprilia	Aprilia
Atlantic 250	Atlantic 250 EU3	Atlantic 300	Atlantic 500	Atlantic Arrecife 125	Atlantic Arrecife 200	Atlantic Arrecife 250	Atlantic Arrecife 400	Atlantic Arrecife 500	Atlantic Sprint 400	Atlantic Sprint 500
03-05	06-08	10-11	01-04	-00	-00	-00	-00	05-08	05-08	05-08
250cc 4T LC	250cc 4T LC	300cc 4T LC	500cc 4T LC	125cc 4T LC	200cc 4T LC	250cc 4T LC	400cc 4T LC	500cc 4T LC	400cc 4T LC	500cc 4T LC
Piaggio	Piaggio M237M	Piaggio			Piaggio M234M	Piaggio M237M	Piaggio M348M	Piaggio M273M	Piaggio M348M	Piaggio M273M
	FZ00395	FZ00395	FZ00384	FZ00377	FZ00377					
			9927630	9927650			9927630	9927630	9927630	9927630
CT00735										
FO07515	FO07515	FO07515		FO07515	FO07515	FO07515				
	FZ00382		FZ00383	FZ00378	FZ00378	FZ00382				
AA00828	AA00828	AA00828		AA00817	AA00817					
	9931880	9931880	9922330							
			9926780				9926780	9926780	9926780	9926780
MA00016	MA00016	MA00016								
	RE00004		RE00004						RE00004	RE00004
	RL00041	RL00021	RL00021		RL00021	RL00021	RL00021	RL00021	RL00021	RL00021
RL00023	RL00023	RL00023	RL00023				RL00023	RL00023	RL00023	RL00023
	ST00023		ST00005						ST00005	ST00005
	9923650	9923650	9923250	9923600	9923650	9923650	9924760	9923250	9924760	9923250

MAXI SCOOTER



Leonardo 125	Leonardo 125	Leonardo 150	Leonardo 150	Leonardo 250	Leonardo 250
96-98	99-02	96-98	99-02	99-01	02-04
125cc 4T LC	125cc 4T LC	150cc 4T LC	150cc 4T LC	250cc 4T LC	250cc 4T LC
Rotax	Rotax	Rotax	Rotax	Minarelli YP	Minarelli YP

ALBERO A CAMME								
ALBERO MOTORE		Sel. 1				IM07054	IM07054	
		Sel. 2						
BIELLA						IM07037	IM07037	
CAMPANA FRIZIONE							FZ00397	
CINGHIA DI TRASMISSIONE		Bando	9915220	9915220	9915220	9915220	9915800	9915800
		Mitsuboshi	9935660	9935660	9935660	9935660	9935710	9935710
		Altro						
COLLETTORE ASPIRAZIONE								
FILTRO OLIO			FO07516	FO07516	FO07516	FO07516		
FRIZIONE						FZ00401	FZ00388	
GRUPPO TERMICO		Standard				9926850	9926850	
		Maggiorato						
KIT CUSCINETTI/PARAOLI DI BANCO		Serie				KK01007	KK01007	
KIT REVISIONE POMPA ACQUA			AA00811	AA00810	AA00811	AA00810	AA00806	AA00806
MASSE CENTRIFUGHE PESO ORIGINALE			9916260	9916260	9915310		9918020	9918020
MEMBRANA CARBURATORE		Tipo originale					MC12001	MC12001
		Adattabile					MC12101	MC12101
MOLLA CONTRASTO VARIATORE							9929870	9929870
MOTORINO D'AVVIAMENTO			MA00022	MA00022	MA00022	MA00022	MA00010	MA00010
REGOLATORE DI TENSIONE								
RUOTA LIBERA		Complete						
		RL + flangia					RL00010	RL00010
		RL nuda	RL00005	RL00005	RL00005	RL00005		
		Ingranaggio	RL00013	RL00013	RL00013	RL00013	RL00011	RL00011
		Flangia	RL00014	RL00014	RL00014	RL00014		
SERIE DISCHI FRIZIONE								
STATORE								
VARIATORE VARIOTOP TPR							9931790	9931790

MAXI SCOOTER

Aprilia	Aprilia	Aprilia	Aprilia	Aprilia	Aprilia	Aprilia	Aprilia	Aprilia	Aprilia	Aprilia
Leonardo 250 ST	Leonardo 300	Leonardo ST	Mojito 125	Mojito 125	Mojito 150	Mojito Retrò Custom	SR 125	SR 150	SR MAX	SR MAX 125
01-01	02-04	03-04	03-07	08-08	03-07	99-01	99-01	99-01	11-14	11-14
250cc 4T LC	300cc 4T LC	125cc 4T LC	125cc 4T AC	125cc 4T AC	150cc 4T AC	125cc 4T AC	125cc 2T AC	150cc 2T AC	125cc 4T-4V LC	125cc 4T LC
Minarelli YP	Minarelli YP	Rotax	Leader	Piaggio			Piaggio	Piaggio	Piaggio	Piaggio
IM07054			IM070701	IM070701						
			IM070702	IM070702						
IM07037	IM07037									
	FZ00397		FZ00395	FZ00395	FZ00395					
9915800	9915800	9915220					9915350	9915350		
9935710	9935710	9935660	9927650	9927650	9927650		9935670	9935670		9927650
			CT00736	CT00736			CT00728	CT00728		
		FO07516	FO07515	FO07515	FO07515	FO07514				FO07515
FZ00401	FZ00388		FZ00396	FZ00396						
9926850										
KK01007	KK01007									
AA00806	AA00806	AA00810								
9918020	9918020	9916260								
MC12001	MC12001		MC12002	MC12002	MC12002					
MC12101	MC12101									
9929870										
MA00010	MA00010	MA00022	MA00012	MA00012		MA00013				MA00016
			RE00011	RE00011	RE00011	RE00012				RE00004
RL00010	RL00010									RL00041
		RL00005								
RL00011	RL00011	RL00013	RL00022	RL00022	RL00022					RL00023
		RL00014								
									ST00023	
9931790			9923600	9923600	9923600					9923600

MAXI SCOOTER



Aprilia	Aprilia	Aprilia	Aprilia	Aprilia	Aprilia
SR MAX 300	SR Motard 125	Scarabeo 100 (Minarelli)	Scarabeo 100 (Yamaha)	Scarabeo 125	Scarabeo 125
11-14	12-12	00-00	00-00	99-03	03-03
300cc 4T LC	125cc 4T-2V AC	100cc 2T AC	100cc 2T AC	125cc 4T LC	125cc 4T LC
Piaggio	Piaggio	Minarelli	Yamaha	Rotax	Piaggio

ALBERO A CAMME						
ALBERO MOTORE		Sel. 1				
		Sel. 2				
BIELLA						
CAMPANA FRIZIONE			FZ00395			FZ00395
CINGHIA DI TRASMISSIONE		Bando			9915220	
		Mitsuboshi	9927650		9935660	9928540
		Altro				
COLLETTORE ASPIRAZIONE			CT00736			CT00734
FILTRO OLIO			FO07515	FO07515		FO07516
FRIZIONE				FZ00418		FZ00396
GRUPPO TERMICO		Standard				
		Maggiorato				
KIT CUSCINETTI/PARAOLI DI BANCO		Serie				
KIT REVISIONE POMPA ACQUA			AA00828		AA00810	
MASSE CENTRIFUGHE PESO ORIGINALE			9931880		9916260	
MEMBRANA CARBURATORE		Tipo originale				
		Adattabile				
MOLLA CONTRASTO VARIATORE						
MOTORINO D'AVVIAMENTO			MA00016	MA00012		MA00022
REGOLATORE DI TENSIONE			RE00004	RE00012	RE00014	RE00014
		Complete				
RUOTA LIBERA		RL + flangia	RL00021			
		RL nuda			RL00005	
		Ingranaggio	RL00023	RL00022		RL00013
		Flangia				RL00014
SERIE DISCHI FRIZIONE						
STATORE						
VARIATORE VARIOTOP TPR			9923650	9923600		9923600

MAXI SCOOTER

Aprilia	Aprilia	Aprilia	Aprilia	Aprilia	Aprilia	Aprilia	Aprilia	Aprilia	Aprilia	Aprilia
Scarabeo 125	Scarabeo 150	Scarabeo 150	Scarabeo 200	Scarabeo 200	Scarabeo 250	Scarabeo 4T 100	Scarabeo 4T 100	Scarabeo 4T NET 100	Scarabeo 4T NET EU3 100	Scarabeo 4T Restyling 100
04-06	99-03	04-06	01-03	03-03	04-06	01-04	10-12	10-10	10-10	06-09
125cc 4T LC	150cc 4T LC	150cc 4T LC	200cc 4T LC	200cc 4T LC	250cc 4T LC	100cc 4T AC	100cc 4T AC	100cc 4T AC	100cc 4T AC	100cc 4T AC
Piaggio	Rotax	Piaggio	Rotax	Piaggio	Piaggio M258M	Piaggio	Piaggio	Piaggio	Piaggio	Piaggio
FZ00377					FZ00377					
	9915220					9935210	9935210	9935210	9935210	9935210
9928540	9935660	9928540			9927640					
CT00734					CT00735					
FO07515	FO07516	FO07515	FO07516	FO07515	FO07515					
FZ00396					FZ00382					
AA00817	AA00810	AA00817			AA00828					
	9915310			9932790						
MA00012	MA00022		MA00022		MA00016					
RE00011		RE00011				RE00018	RE00018	RE00018	RE00018	RE00018
	RL00005		RL00005							
RL00022	RL00013	RL00022	RL00013	RL00022	RL00023					
	RL00014		RL00014							
						ST00004	ST00004	ST00004	ST00004	ST00004
9923600		9923600			9923650					

MAXI SCOOTER



Aprilia	Aprilia	Aprilia	Aprilia	Aprilia	Aprilia
Scarabeo 500	Scarabeo EU3 125	Scarabeo EU3 200	Scarabeo IE Light 125	Scarabeo IE Light 125	Scarabeo IE Light 200
03-06	06-07	06-07	09-10	11-12	11-12
500cc 4T LC	125cc 4T LC	200cc 4T LC	125cc 4T LC	125cc 4T LC	200cc 4T LC
Piaggio	Piaggio	Piaggio	Motore Aprilia	Motore Aprilia	Motore Aprilia

ALBERO A CAMME						
ALBERO MOTORE		Sel. 1		IM070701		
		Sel. 2		IM070702		
BIELLA						
CAMPANA FRIZIONE			FZ00384	FZ00395		
CINGHIA DI TRASMISSIONE		Bando			9935220	9935220
		Mitsuboshi	9927630	9928540		
		Altro				
COLLETORE ASPIRAZIONE						
FILTRO OLIO				FO07515	FO07515	
FRIZIONE			FZ00383	FZ00396		
GRUPPO TERMICO		Standard				
		Maggiorato				
KIT CUSCINETTI/PARAOLI DI BANCO		Serie				
KIT REVISIONE POMPA ACQUA				AA00826		
MASSE CENTRIFUGHE PESO ORIGINALE			9922330	9932790		
MEMBRANA CARBURATORE		Tipo originale				
		Adattabile				
MOLLA CONTRASTO VARIATORE			9926780			
MOTORINO D'AVVIAMENTO				MA00012		
REGOLATORE DI TENSIONE			RE00004	RE00011		
RUOTA LIBERA		Complete				
		RL + flangia	RL00021			
		RL nuda				
		Ingranaggio	RL00023	RL00022	RL00022	
		Flangia				
SERIE DISCHI FRIZIONE						
STATORE			ST00005			
VARIATORE VARIOTOP TPR			9923250	9923600	9923650	9923600
					9923600	9923600

MAXI SCOOTER

Aprilia	Aprilia	Aprilia	Aprilia	Aprilia	Aprilia	Aprilia	Aprilia	Aprilia	Aprilia	Aprilia
Scarabeo Light 125	Scarabeo Light 200	Scarabeo Light 250	Scarabeo Light 300	Scarabeo Light 400	Scarabeo Light 500	Sport City Street 125	Sportcity 125	Sportcity 125 EU3	Sportcity 200	Sportcity 200 EU3
07-08	07-08	06-08	09-10	06-08	06-08	12-12	04-06	06-08	04-06	06-08
125cc 4T LC	200cc 4T LC	250cc 4T LC	300cc 4T LC	400cc 4T LC	500cc 4T LC	125cc 4T LC	125cc 4T LC	125cc 4T LC	200cc 4T LC	200cc 4T LC
Aprilia BA03	Aprilia CA03	Piaggio	Piaggio	Piaggio	Piaggio	Piaggio	Piaggio M281M	Piaggio		Piaggio M288M
								IM070701		
								IM070702		
		FZ00395	FZ00395			FZ00395	FZ00377	FZ00395	FZ00377	FZ00395
9935220										
		9927640	9927640	9927630	9927630	9928540	9928540	9928540		
							CT00734			
		FO07515	FO07515			FO07515	FO07515	FO07515	FO07515	FO07515
							FZ00396	FZ00396	FZ00378	
		AA00828	AA00828	AA00824	AA00824	AA00826	AA00817	AA00826	AA00817	
		9931880	9931880	9924530					9932790	9932790
				9926780	9926780					
		MA00016	MA00016			MA00012	MA00012	MA00012		
		RE00004	RE00004	RE00004	RE00004	RE00011	RE00011	RE00011		
		RL00041	RL00021	RL00021	RL00021			RL00041		
		RL00023	RL00023	RL00023	RL00023	RL00022	RL00022	RL00022	RL00022	RL00022
		ST00023	ST00023	ST00005	ST00005			ST00023		
9923600	9923650	9923650	9923650	9924760	9923250	9923600	9923600	9923600	9923650	9923650

MAXI SCOOTER



Aprilia	Aprilia	Aprilia	Aprilia	Aprilia	Aprilia
Sportcity 250	Sportcity 250 EU3	Sportcity Cube 125	Sportcity Cube 200	Sportcity Cube 250	Sportcity Cube 300
-00	06-08	08-10	08-10	08-12	08-10
250cc 4T LC	250cc 4T LC	125cc 4T LC	125cc 4T LC	250cc 4T LC	300cc 4T LC
	Piaggio M288M	Piaggio	Piaggio	Piaggio	Leader M28LM

ALBERO A CAMME						
ALBERO MOTORE		Sel. 1		IM070701		
		Sel. 2		IM070702		
BIELLA						
CAMPANA FRIZIONE			FZ00395	FZ00395	FZ00395	FZ00395
CINGHIA DI TRASMISSIONE		Bando				
		Mitsuboshi	9927640	9927640	9928540	9927640
		Altro				
COLLETTORE ASPIRAZIONE						
FILTRO OLIO			FO07515	FO07515	FO07515	FO07515
FRIZIONE			FZ00382	FZ00382	FZ00396	
GRUPPO TERMICO		Standard				
		Maggiorato				
KIT CUSCINETTI/PARAOLI DI BANCO		Serie				
KIT REVISIONE POMPA ACQUA				AA00826		
MASSE CENTRIFUGHE PESO ORIGINALE				9931880		9931880
MEMBRANA CARBURATORE		Tipo originale				
		Adattabile				
MOLLA CONTRASTO VARIATORE						
MOTORINO D'AVVIAMENTO				MA00016	MA00012	MA00016
REGOLATORE DI TENSIONE				RE00004	RE00011	RE00004
RUOTA LIBERA		Complete				
		RL + flangia				RL00041
		RL nuda				RL00021
		Ingranaggio	RL00023	RL00022	RL00022	RL00023
		Flangia				RL00023
SERIE DISCHI FRIZIONE						
STATORE					ST00023	
VARIATORE VARIOTOP TPR			9923650	9923650	9923600	9923650

MAXI SCOOTER

Aprilia	Aprilia	BMW	BMW	BMW	BMW	Benelli	Benelli	Benelli	Benelli	Benelli
Sportcity One 4T EU3 125	Sprot City Street 300	C1 125	C1 200	C 650 GT	C 650 Sport	Adiva 125	Adiva 150	Adiva 250 EU2	K2 100	Velvet 125
08-11	12-12	00-03	02-03	16-16	16-16	01-02	01-02	-00	99-01	99-01
125cc 4T AC	300cc 4T-4V LC	125cc 4T LC	200cc 4T LC	650cc 4T LC	650cc 4T LC	125cc 4T AC	150cc 4T AC	250cc 4T LC	100cc 2T AC	125cc 4T LC
Leader M38AM	Piaggio	Tipo Rotax	Tipo Rotax			Leader	Leader	Leader	Minarelli	Minarelli YP
IM070701										IM07045
IM070702										
FZ00395	FZ00395									
		9915220	9915220							9915380
9927650	9927640	9935660	9935660	9935230	9935230	9927650	9927650			9935700
CT00736										CT00730
FO07515	FO07515	FO07516	FO07516			FO07515	FO07515	FO07515		
FZ00418										
										9929380
										KK01010
	AA00828	AA00810								AA00805
	9931880									9915270
										MC12000
										MC12100
									9914470	9929170
MA00012	MA00016									MA00017
RE00011	RE00004									
	RL00021									RL00002
		RL00005	RL00005							
RL00022	RL00023	RL00013	RL00013							
		RL00014	RL00014							
9923600	9923650			9934100	9934100	9923600	9923600	9923650		9923550

MAXI SCOOTER



Benelli	Benelli	Benelli	Benelli	Benelli	Benelli
Velvet 125 Touring	Velvet 150	Velvet 150 Touring	Velvet 250	Velvet 250	Velvet Dusk 400
02-03	99-01	02-03	99-01	02-03	03-04
125cc 4T LC	150cc 4T LC	150cc 4T LC	250cc 4T LC	250cc 4T LC	400cc 4T LC
Minarelli YP	Minarelli YP	Minarelli YP	Minarelli YP	Minarelli YP	Morini

ALBERO A CAMME							
ALBERO MOTORE		Sel. 1 Sel. 2			IM07054	IM07054	
BIELLA					IM07037	IM07037	
CAMPANA FRIZIONE							
CINGHIA DI TRASMISSIONE		Bando Mitsuboshi Altro	9915380 9935700	9915380 9935700	9915380 9935700	9915800 9935710	
COLLETTORE ASPIRAZIONE				CT00730			
FILTRO OLIO						FO07510	
FRIZIONE							
GRUPPO TERMICO		Standard Maggiorato			9926850	9926850	
KIT CUSCINETTI/PARAOLI DI BANCO		Serie		KK01010	KK01007	KK01007	
KIT REVISIONE POMPA ACQUA				AA00805	AA00806	AA00806	
MASSE CENTRIFUGHE PESO ORIGINALE					9918020	9918020	9922390
MEMBRANA CARBURATORE		Tipo originale Adattabile		MC12000 MC12100	MC12001 MC12101	MC12001 MC12101	
MOLLA CONTRASTO VARIATORE				9929170	9929870	9929870	
MOTORINO D'AVVIAMENTO			MA00017	MA00017	MA00017	MA00010	MA00010
REGOLATORE DI TENSIONE							
RUOTA LIBERA		Complete RL + flangia RL nuda Ingranaggio Flangia		RL00002	RL00010	RL00010	
SERIE DISCHI FRIZIONE							
STATORE							
VARIATORE VARIOTOP TPR				9923550	9931790	9931790	9922430

MAXI SCOOTER

Beta	Beta	Cagiva	Derbi	Derbi	Derbi	Derbi	Derbi	Derbi	Derbi	Derbi
Eikon 125	Eikon 150	Cucciolo 125	Atlantis 100	Boulevard 125	Boulevard 125	Boulevard 125 EU3	Boulevard 150	Boulevard 150	Boulevard 150 EU3	Boulevard 200 EU2
00-02	00-02	00-00	00-01	02-02	03-04	04-07	02-02	03-04	04-07	05-06
125cc 4T LC	150cc 4T LC	125cc 4T AC	100cc 2T AC	125cc 4T AC	125cc 4T AC	125cc 4T AC	150cc 4T AC	150cc 4T AC	150cc 4T AC	200cc 4T AC
				Leader	Piaggio	Piaggio	Leader	Piaggio	Piaggio	Piaggio M387M
						IM070701			IM070701	
						IM070702			IM070702	
				FZ00377	FZ00377	FZ00377	FZ00377	FZ00377	FZ00377	FZ00395
9915220	9915220									
9935660	9935660			9927650	9927650	9927650	9927650	9927650	9927650	
				CT00740	CT00736	CT00736	CT00740	CT00736	CT00736	CT00736
				FO07515	FO07515	FO07515	FO07515	FO07515	FO07515	FO07515
				FZ00396	FZ00396	FZ00396	FZ00396	FZ00396	FZ00396	
9916710	9916710									9932790
						MC12002		MC12002		
		MA00013		MA00012	MA00012	MA00012	MA00012	MA00012	MA00012	MA00012
			RE00025	RE00011	RE00011	RE00011	RE00011	RE00011	RE00011	RE00011
				RL00022	RL00022	RL00022	RL00022	RL00022	RL00022	RL00022
				9923600	9923600		9923600	9923600		9923650

MAXI SCOOTER



Derbi	Derbi	Derbi	Derbi	Derbi	Derbi
Boulevard 4T 100	Boulevard 4T E3	Boulevard 4T EU3	GP1 125 EU 2	GP1 250	GP1 250 Low Seat EU3
10-10	10-10	08-12	06-06	06-07	07-08
100cc 4T AC	150cc 4T AC	125cc 4T AC	125cc 4T LC	250cc 4T LC	250cc 4T LC
Piaggio	Piaggio	Piaggio		Piaggio	Piaggio

ALBERO A CAMME							
ALBERO MOTORE		Sel. 1		IM070701	IM070701	IM070701	
		Sel. 2		IM070702	IM070702	IM070702	
BIELLA							
CAMPANA FRIZIONE				FZ00395	FZ00377	FZ00395	
CINGHIA DI TRASMISSIONE		Bando					
		Mitsuboshi		9927650	9927650	9927650	
		Altro					
COLLETTORE ASPIRAZIONE				CT00736	CT00736	CT00735	
FILTRO OLIO				FO07515	FO07515	FO07515	
FRIZIONE				FZ00418	FZ00418	FZ00396	
GRUPPO TERMICO		Standard					
		Maggiorato					
KIT CUSCINETTI/PARAOLI DI BANCO		Serie					
KIT REVISIONE POMPA ACQUA					AA00826		
MASSE CENTRIFUGHE PESO ORIGINALE							
MEMBRANA CARBURATORE		Tipo originale					
		Adattabile					
MOLLA CONTRASTO VARIATORE							
MOTORINO D'AVVIAMENTO				MA00012	MA00012	MA00012	
REGOLATORE DI TENSIONE			RE00018	RE00011	RE00011	RE00011	
RUOTA LIBERA		Complete					
		RL + flangia				RL00021	RL00041
		RL nuda					
		Ingranaggio		RL00022	RL00022	RL00022	RL00023
FRANGIA							
SERIE DISCHI FRIZIONE							
STATORE			ST00004			ST00023	
VARIATORE VARIOTOP TPR					9923600	9923650	

MAXI SCOOTER

Derbi	Derbi	Derbi	Derbi	Derbi	Derbi	Derbi	Derbi	Derbi	Gilera	Gilera
GP1 Low Seat EU3	Rambla 125	Rambla 125 EU3 2VER	Rambla 250	Rambla 250 EU3 2VER	Rambla 300	Sonar 4T 125	Sonar 4T 150	Variant Sport 4T EU3	DNA 125	DNA 180
07-08	08-09	08-08	08-09	08-08	10-11	09-11	09-09	12-12	01-01	01-01
125cc 4T LC	125cc 4T LC	125cc 4T LC	250cc 4T LC	250cc 4T LC	300cc 4T LC	125cc 4T AC	150cc 4T AC	125cc 4T AC	125cc 4T LC	180cc 4T LC
Piaggio	Piaggio M287M	Piaggio	Piaggio	Piaggio	Piaggio	Piaggio	Piaggio	Motore Piaggio	Piaggio	Piaggio
IM070701	IM070701	IM070701				IM070701	IM070701	IM070701		
IM070702	IM070702	IM070702				IM070702	IM070702			
FZ00395	FZ00395		FZ00395	FZ00395	FZ00395				FZ00377	FZ00377
9927650	9928540		9927640	9927640	9927640	9927650	9927650	9927650	9927650	
						CT00736	CT00736	CT00736	CT00734	CT00734
FO07515	FO07515	FO07515	FO07515	FO07515	FO07515	FO07515	FO07515	FO07515	FO07515	FO07515
FZ00396	FZ00396					FZ00418	FZ00418	FZ00418	FZ00396	
AA00826	AA00826	AA00826	AA00828	AA00828	AA00828				AA00817	
			9931880	9931880	9931880					9932790
MA00012	MA00012	MA00012	MA00016	MA00016	MA00016	MA00012	MA00012	MA00012	MA00012	MA00012
RE00011	RE00011	RE00011	RE00004	RE00004	RE00004	RE00011	RE00011	RE00011	RE00011	RE00011
	RL00041	RL00041	RL00041	RL00041	RL00021					
RL00022	RL00022	RL00022		RL00023	RL00023	RL00022	RL00022	RL00022	RL00022	RL00022
	ST00023	ST00023	ST00023		ST00023					
	9923600			9923650					9923600	

MAXI SCOOTER



Gilera	Gilera	Gilera	Gilera	Gilera	Gilera
Fuoco 500 IE EU3	Nexus 125 EU3	Nexus 125 IE EU3	Nexus 125 IE EU3	Nexus 250 EU3	Nexus 250 EU3
07-13	07-08	08-08	09-10	06-06	07-07
500cc 4T LC	125cc 4T LC	125cc 4T LC	125cc 4T LC	250cc 4T LC	250cc 4T LC
Piaggio	Piaggio	Piaggio	Piaggio	Piaggio	Piaggio

ALBERO A CAMME							
ALBERO MOTORE		Sel. 1		IM070701			
		Sel. 2		IM070702			
BIELLA							
CAMPANA FRIZIONE			FZ00384	FZ00395	FZ00395	FZ00395	
CINGHIA DI TRASMISSIONE		Bando					
		Mitsuboshi	9927630	9927650	9927650	9927650	
		Altro					
COLLETORE ASPIRAZIONE							
FILTRO OLIO				FO07515	FO07515	FO07515	
FRIZIONE				FZ00396	FZ00396	FZ00382	
GRUPPO TERMICO		Standard					
		Maggiorato					
KIT CUSCINETTI/PARAOLI DI BANCO		Serie					
KIT REVISIONE POMPA ACQUA			AA00824	AA00826		AA00828	
MASSE CENTRIFUGHE PESO ORIGINALE					9931880		
MEMBRANA CARBURATORE		Tipo originale					
		Adattabile					
MOLLA CONTRASTO VARIATORE							
MOTORINO D'AVVIAMENTO				MA00012	MA00016	MA00016	
REGOLATORE DI TENSIONE			RE00004	RE00011	RE00004	RE00004	
RUOTA LIBERA		Complete					
		RL + flangia	RL00021		RL00041	RL00041	RL00041
		RL nuda					
		Ingranaggio	RL00023	RL00022	RL00023	RL00023	RL00023
Flangia							
SERIE DISCHI FRIZIONE							
STATORE				ST00023	ST00023	ST00023	
VARIATORE VARIOTOP TPR			9923250	9923600	9923600	9923650	

MAXI SCOOTER

Gilera	Gilera	Gilera	Gilera	Gilera	Gilera	Gilera	Gilera	Gilera	Gilera	Gilera
Nexus 300 EU3	Nexus 300 EU3	Nexus 500	Nexus 500 EU3	Nexus 500 EU3	Nexus SP 250 EU3	Nexus SP 500 EU3	Runner 180	Runner 4T ST EU3 125	Runner FX 125	Runner FXR 180
08-08	09-11	03-05	06-08	09-11	06-07	06-07	00-01	08-13	97-02	97-02
300cc 4T LC	300cc 4T LC	500cc 4T LC	500cc 4T LC	500cc 4T LC	250cc 4T LC	500cc 4T LC	180cc 4T LC	125cc 4T LC	125cc 2T LC	180cc 2T LC
Piaggio	Piaggio	Piaggio	Piaggio	Piaggio	Piaggio	Piaggio	Piaggio	Piaggio	Piaggio	Piaggio
FZ00395	FZ00395	FZ00384	FZ00384	FZ00384		FZ00384	FZ00377			
									9915350	9915340
		9927630	9927630	9927630		9927630		9927650	9935670	9935780
								CT00735	CT00728	CT00728
FO07515	FO07515				FO07515		FO07515	FO07515		
		FZ00383					FZ00378			
AA00828	AA00828		AA00824		AA00828		AA00817	AA00826		
9931880	9931880	9922330			9931880					9922670
		9926780								
MA00016	MA00016				MA00016			MA00012		
RE00004	RE00004	RE00004	RE00004	RE00004	RE00004	RE00004		RE00011		
RL00021	RL00021	RL00021	RL00021	RL00021	RL00041	RL00021				
RL00023	RL00023	RL00023	RL00023	RL00023	RL00023	RL00023		RL00022		
ST00023	ST00023	ST00005	ST00005	ST00005	ST00023	ST00005				
9923650	9923650	9923250					9923600			

MAXI SCOOTER



Gilera	Gilera	Gilera	Gilera	Gilera	Gilera
Runner VX 125	Runner VX 125	Runner VX 125	Runner VX 4T EU3 125	Runner VX Race 125	Runner VX SC
00-01	02-04	05-06	06-07	06-06	06-07
125cc 4T LC	125cc 4T LC	125cc 4T LC	125cc 4T LC	125cc 4T LC	125cc 4T LC
Piaggio	Piaggio	Piaggio	Piaggio	Piaggio	Piaggio

ALBERO A CAMME							
ALBERO MOTORE		Sel. 1	IM070701	IM070701	IM070701	IM070701	
		Sel. 2	IM070702	IM070702	IM070702	IM070702	
BIELLA							
CAMPANA FRIZIONE		FZ00377	FZ00377	FZ00377			
CINGHIA DI TRASMISSIONE		Bando					
		Mitsuboshi	9927650	9927650	9927650	9927650	9927650
		Altro					
COLLETTORE ASPIRAZIONE		CT00734	CT00734	CT00735	CT00735	CT00735	
FILTRO OLIO		FO07515	FO07515	FO07515	FO07515	FO07515	
FRIZIONE		FZ00378	FZ00378	FZ00378			
GRUPPO TERMICO		Standard					
		Maggiorato					
KIT CUSCINETTI/PARAOLI DI BANCO		Serie					
KIT REVISIONE POMPA ACQUA			AA00817	AA00817	AA00817	AA00826	
MASSE CENTRIFUGHE PESO ORIGINALE							
MEMBRANA CARBURATORE		Tipo originale					
		Adattabile					
MOLLA CONTRASTO VARIATORE							
MOTORINO D'AVVIAMENTO			MA00012	MA00012	MA00012	MA00012	
REGOLATORE DI TENSIONE			RE00011	RE00011	RE00011	RE00011	
RUOTA LIBERA		Complete					
		RL + flangia					
		RL nuda					
		Ingranaggio	RL00022	RL00022	RL00022	RL00022	RL00022
		Flangia					
SERIE DISCHI FRIZIONE							
STATORE							
VARIATORE VARIOTOP TPR			9923600	9923600	9923600		

MAXI SCOOTER

Gilera	Gilera	Gilera	Gilera	Gilera	Gilera	Gilera	Gilera	Honda	Honda	Honda
Runner VXR 180	Runner VXR 200	Runner VXR 200	Runner VXR 4T ST EU3 200	Runner VXR EU3 200	Runner VXR Race 200	Typhoon 125	Typhoon 125 X-XR	@ [NES] 125	@ [NES] 150	Bali 125
00-01	02-04	05-06	08-11	07-07	06-06	95-98	99-00	00-06	00-06	-00
180cc 4T LC	200cc 4T LC	200cc 4T LC	200cc 4T LC	200cc 4T LC	125cc 4T LC	125cc 2T AC	125cc 2T AC	125cc 4T LC	150cc 4T LC	125cc 4T AC
Piaggio	Piaggio	Piaggio	Piaggio	Piaggio	Piaggio	Piaggio	Piaggio	Honda	Honda	Honda
								IM07055	IM07056	
FZ00377	FZ00395	FZ00395						FZ00375	FZ00375	
						9915350	9915350			
						9935670	9935670	9935770	9935770	9935770
								9923140	9923140	9923140
CT00734	CT00734	CT00735		CT00735	CT00735	CT00728	CT00728			
FO07515	FO07515	FO07515	FO07515	FO07515	FO07515					
FZ00378								FZ00386	FZ00386	
								9929650	9929950	
								9929450		
AA00817	AA00826	AA00826	AA00826	AA00826				AA00813	AA00813	
9932790	9932790	9932790	9932790	9932790				9916670	9924320	
								MC12004	MC12004	
								9926770	9926770	
MA00012	MA00012	MA00012	MA00012	MA00012	MA00012			MA00006	MA00006	
	RE00011	RE00011	RE00011	RE00011	RE00011					
								RL00003	RL00003	
								RL00005	RL00005	
RL00022	RL00022	RL00022	RL00022	RL00022	RL00022					
9923600	9923650	9923650						9923410	9923410	9923410

MAXI SCOOTER



Honda	Honda	Honda	Honda	Honda	Honda
Bali 150	CN 250 Spazio/Helix	Dylan 125 [SES]	Dylan 150 [SES]	Foresight 250 [FES]	Foresight 250 [FES] D.D.
-00	86-99	02-04	02-04	98-99	00-05
150cc 4T AC	250cc 4T LC	125cc 4T LC	150cc 4T LC	250cc 4T LC	250cc 4T LC
Honda	Honda	Honda	Honda	Honda	Honda

ALBERO A CAMME							
ALBERO MOTORE		Sel. 1		IM07055	IM07056		
		Sel. 2					
BIELLA							
CAMPANA FRIZIONE				FZ00375	FZ00375	FZ00391	
CINGHIA DI TRASMISSIONE		Bando		9915410		9917990	
		Mitsuboshi	9935770		9935770	9935770	9935720
		Altro	9923140		9923140	9923140	
COLLETTORE ASPIRAZIONE							
FILTRO OLIO							
FRIZIONE				FZ00386	FZ00386	FZ00390	
GRUPPO TERMICO		Standard		9929650	9929950		
		Maggiorato		9929450			
KIT CUSCINETTI/PARAOLI DI BANCO		Serie					
KIT REVISIONE POMPA ACQUA				AA00813	AA00813	AA00814	
MASSE CENTRIFUGHE PESO ORIGINALE				9916670	9924320	9915990	
MEMBRANA CARBURATORE		Tipo originale		MC12004	MC12004		
		Adattabile					
MOLLA CONTRASTO VARIATORE				9926770	9926770	9926800	
MOTORINO D'AVVIAMENTO				MA00006	MA00006		
REGOLATORE DI TENSIONE							
RUOTA LIBERA		Complete					
		RL + flangia		RL00004	RL00003	RL00003	RL00004
		RL nuda			RL00005	RL00005	
		Ingranaggio					
Flangia							
SERIE DISCHI FRIZIONE							
STATORE							
VARIATORE VARIOTOP TPR			9923410	9923410	9923410	9923750	

MAXI SCOOTER

Honda	Honda	Honda	Honda	Honda	Honda	Honda	Honda	Honda	Honda	Honda
Forza 250 [NSS A]	Forza 250 [NSS S]	Forza 250 [NSS]	Forza EX 250 [NSS]	Forza X 250 [NSS]	Jazz 250 ES Reflex [NSS]	Jazz 250 Reflex [NSS]	PCX 125	PS I 125 [PES]	PS I 150 [PES]	Pantheon 125 IE [FES]
08-11	08-11	02-07	05-07	05-07	01-04	01-01	10-13	06-10	06-10	03-05
250cc 4T-4V LC	250cc 4T-4V LC	250cc 4T-2V LC	250cc 4T-2V LC	250cc 4T-2V LC	250cc 4T-2V LC	250cc 4T-2V LC	125cc 4T-2V LC	125cc 4T LC	150cc 4T LC	125cc 4T-2V LC
Honda	Honda	Honda	Honda	Honda	Honda	Honda	Honda	Honda	Honda	Honda
								IM07055	IM07056	IM07055
		FZ00391			FZ00391	FZ00391	FZ00406	FZ00375	FZ00375	FZ00375
		9917990			9917990	9917990				
		9935720			9935720	9935720		9935770	9935770	9935770
								9923140	9923140	9923140
FO07513	FO07513									
							FZ00407	FZ00386	FZ00386	
								9929650	9929950	9929650
								9929450		9929450
							AA00834	AA00813	AA00813	AA00813
								9916670	9924320	9916670
		9926800		9926800	9926800	9926800		9926770	9926770	9926770
								MA00006	MA00006	MA00006
RL00030	RL00030	RL00004	RL00030	RL00030	RL00004	RL00004		RL00003	RL00003	RL00003
								RL00005	RL00005	RL00005
RL00029	RL00029									
								9923410	9923410	9923410

MAXI SCOOTER



Honda	Honda	Honda	Honda	Honda	Honda
Pantheon 125 [FES]	Pantheon 150 IE [FES]	Pantheon 150 [FES]	SH 125	SH 125 i ABS	SH 150
98-02	03-05	98-02	01-04	13-16	01-04
125cc 2T LC	150cc 4T-2V LC	150cc 2T LC	125cc 4T-2V LC	125cc 4T-2V LC	150cc 4T-2V LC
Honda	Honda	Honda	Honda	Honda	Honda

ALBERO A CAMME						
ALBERO MOTORE		Sel. 1	IM07056	IM07055	IM07056	
		Sel. 2				
BIELLA						
CAMPANA FRIZIONE		FZ00391	FZ00375	FZ00391	FZ00375	FZ00406
CINGHIA DI TRASMISSIONE		Bando	9918000	9918000		
		Mitsuboshi		9935770	9935770	9935770
		Altro		9923140	9923140	9923140
COLLETORE ASPIRAZIONE						
FILTRO OLIO						
FRIZIONE			FZ00386	FZ00386		FZ00386
GRUPPO TERMICO		Standard	9929950	9929650	9929950	
		Maggiorato		9929450		
KIT CUSCINETTI/PARAOLI DI BANCO		Serie				
KIT REVISIONE POMPA ACQUA			AA00812	AA00813	AA00812	AA00813
MASSE CENTRIFUGHE PESO ORIGINALE				9916670	9916710	9924320
MEMBRANA CARBURATORE		Tipo originale		MC12004		MC12004
		Adattabile				
MOLLA CONTRASTO VARIATORE			9926770	9926770		9926770
MOTORINO D'AVVIAMENTO			MA00006	MA00006		MA00006
REGOLATORE DI TENSIONE						
RUOTA LIBERA		Complete				
		RL + flangia	RL00003	RL00003		RL00003
		RL nuda	RL00005	RL00005		RL00005
		Ingranaggio				
		Flangia				
SERIE DISCHI FRIZIONE						
STATORE						
VARIATORE VARIOTOP TPR			9923410	9923410		9923410

MAXI SCOOTER

Honda	Honda	Honda	Honda	Honda	Honda	Honda	Honda	Honda	Honda	Honda
SH 150 i ABS	SH IE 125 Scoopy	SH IE 150 Scoopy	SH IE 300 Scoopy	SH IE 300 Scoopy	SW-T 400 [FJS]	SW-T 600 [FJS]	Silver Wing 125 [FES]	Silver Wing 150 [FES]	Silver Wing 400 [FJS]	Silver Wing 600 [FJS]
13-16	05-12	05-12	07-10	11-16	09-13	11-13	07-12	07-12	06-08	01-10
125cc 4T-2V LC	125cc 4T-2V LC	150cc 4T LC	300cc 4T-4V LC	300cc 4T-4V LC	400cc 4T LC	600cc 4T LC	125cc 4T-2V LC	150cc 4T-2V LC	400cc 4T LC	600cc 4T LC
Honda	Honda	Honda	(NF02E)		Honda	Honda	Honda	(KF06E)	Honda	Honda
	IM07055	IM07056					IM07055	IM07056		
FZ00406	FZ00375	FZ00375	FZ00391	FZ00391			FZ00375	FZ00375		
	9935770	9935770	9927480	9927480	9927490	9935250	9935770	9935770	9927490	
	9923140	9923140					9923140	9923140		
			FO07513	FO07513	FO07513	FO07513			FO07513	FO07513
	FZ00386	FZ00386	FZ00392	FZ00392			FZ00386	FZ00386		
	9929650	9929950					9929650	9929950		
	9929450						9929450			
AA00834	AA00813	AA00813	AA00822	AA00822	AA00836	AA00836	AA00813	AA00813	AA00836	AA00836
	9916670	9924320	9931890	9931890	9931840	9931860	9924320	9924320	9931840	9931860
	9926770	9926770	9929890	9929890			9926770	9926770		
	MA00006	MA00006					MA00006	MA00006		
	RE00021	RE00021	RE00031	RE00029						
	RL00003	RL00003	RL00030	RL00030			RL00003	RL00003		
	RL00005	RL00005					RL00005	RL00005		
			RL00029	RL00029						
	ST00026	ST00026	ST00024							
	9923410	9923410	9926040	9926040			9923410	9923410		

MAXI SCOOTER



Honda	Italjet	Italjet	Italjet	Italjet	Italjet
Vision 110 [NSC]	Dragster 180	Jet Set 125	Jet Set 150	Jupiter 125	Jupiter 150
12-12	-00	-00	-00	-00	-00
110cc 4T-2V AC	180cc 2T LC	125cc 4T AC	150cc 4T AC	125cc 4T LC	150cc 4T LC
Honda		Leader	Leader	Minarelli YP	Minarelli YP

ALBERO A CAMME						
ALBERO MOTORE		Sel. 1 Sel. 2			IM07045	
BIELLA						
CAMPANA FRIZIONE			FZ00404			
CINGHIA DI TRASMISSIONE		Bando Mitsuboshi Altro			9915380 9935700	9915380 9935700
COLLETTORE ASPIRAZIONE					CT00730	CT00730
FILTRO OLIO			FO07515	FO07515		
FRIZIONE			FZ00405		FZ00371	FZ00401
GRUPPO TERMICO		Standard Maggiorato			9929380	9929380
KIT CUSCINETTI/PARAOLI DI BANCO		Serie			KK01010	KK01010
KIT REVISIONE POMPA ACQUA					AA00805	AA00805
MASSE CENTRIFUGHE PESO ORIGINALE			9922670		9915270	
MEMBRANA CARBURATORE		Tipo originale Adattabile			MC12000 MC12100	MC12000 MC12100
MOLLA CONTRASTO VARIATORE					9929170	9929170
MOTORINO D'AVVIAMENTO					MA00017	MA00017
REGOLATORE DI TENSIONE						
RUOTA LIBERA		Complete RL + flangia RL nuda Ingranaggio Flangia			RL00002	RL00002
SERIE DISCHI FRIZIONE						
STATORE						
VARIATORE VARIOTOP TPR			9923600	9923600	9923550	9923550

MAXI SCOOTER

Italjet	Italjet	Italjet	Italjet	Italjet	Italjet	Keeway	Keeway	Keeway	Keeway	Keeway
Jupiter 250	Jupiter 250	Millenium 125	Millenium 150	Torpedo 125	Torpedo 150	Matrix 125	Outlook 125	Outlook 150	Outlook DR 125	Outlook DR 150
00-00	-00	-00	-00	-00	-00	07-08	07-08	07-08	07-11	07-11
250cc 4T LC	250cc 4T LC	125cc 4T LC	150cc 4T LC	125cc 4T AC	150cc 4T AC	125cc 4T AC	125cc 4T LC	150cc 4T LC	125cc 4T LC	150cc 4T LC
Minarelli YP	Minarelli YP	Minarelli YP	Minarelli YP	Leader	Leader		(QJ153MJ-2)	(QJ158MJ)		
IM07054	IM07054	IM07045								
IM07037	IM07037									
FZ00397							FZ00375	FZ00375		
9915800	9915800	9915380	9915380			9935260				
9935710	9935710	9935700	9935700				9935770	9935770	9935770	9935770
							9923140	9923140	9923140	9923140
		CT00730	CT00730							
				FO07515	FO07515					
FZ00388	FZ00401	FZ00371	FZ00401				FZ00386	FZ00386		
9926850	9926850						9929650	9929950		
		9929380	9929380				9929450			
KK01007	KK01007	KK01010	KK01010							
AA00806	AA00806	AA00805	AA00805							
	9918020	9915270								
MC12001	MC12001	MC12000	MC12000							
MC12101	MC12101	MC12100	MC12100							
9929870	9929870	9929170	9929170				9926770	9926770		
MA00010	MA00010	MA00017	MA00017							
RL00010	RL00010	RL00002	RL00002							
RL00011	RL00011									
9931790	9931790	9923550	9923550	9923600	9923600		9923410	9923410		

MAXI SCOOTER



Keeway	Kymco	Kymco	Kymco	Kymco	Kymco
Silverblade 4T 125	Agility 125	Agility 125 EU3	Agility 125 R16	Agility 125 R16	Agility 125 RS
11-11	06-06	06-08	08-08	09-09	09-09
125cc 4T LC	125cc 4T AC	125cc 4T AC	125cc 4T AC	125cc 4T AC	125cc 4T AC

ALBERO A CAMME							
ALBERO MOTORE		Sel. 1		IM07071	IM07071	IM07071	IM07071
		Sel. 2					
BIELLA							
CAMPANA FRIZIONE			FZ00375	FZ00375	FZ00375	FZ00375	FZ00375
CINGHIA DI TRASMISSIONE		Bando		9926430	9926430	9926430	9926430
		Mitsuboshi	9935770	9935740	9935740	9935740	9935740
		Altro	9923140				
COLLETTORE ASPIRAZIONE					CT00742	CT00742	
FILTRO OLIO							
FRIZIONE			FZ00386	FZ00386	FZ00386	FZ00386	FZ00386
GRUPPO TERMICO		Standard					
		Maggiorato					
KIT CUSCINETTI/PARAOLI DI BANCO		Serie					
KIT REVISIONE POMPA ACQUA							
MASSE CENTRIFUGHE PESO ORIGINALE					9917640	9917640	
MEMBRANA CARBURATORE		Tipo originale					
		Adattabile		MC12103	MC12103	MC12103	
MOLLA CONTRASTO VARIATORE							
MOTORINO D'AVVIAMENTO			MA00007	MA00007	MA00007	MA00007	MA00007
REGOLATORE DI TENSIONE			RE00013	RE00013	RE00019	RE00019	RE00019
RUOTA LIBERA		Complete					
		RL + flangia		RL00025	RL00025		
		RL nuda					
		Ingranaggio		RL00024	RL00024		
		Flangia					
SERIE DISCHI FRIZIONE							
STATORE							
VARIATORE VARIOTOP TPR			9927830		9927830	9927830	9927830

MAXI SCOOTER

Kymco	Kymco	Kymco	Kymco	Kymco	Kymco	Kymco	Kymco	Kymco	Kymco	Kymco
Agility 150	Agility 150 R16	Agility 150 R16	Agility 200I R16	Agility I Plus	Agility Plus	Agility R16	Agility R16	B&W 125	B&W 125 EU2	B&W 150
06-08	08-08	09-09	10-10	14-14	14-14	12-12	12-12	00-00	03-04	00-00
150cc 4T AC	150cc 4T AC	150cc 4T AC	200cc 4T AC	200cc 4T AC	125cc 4T AC	200cc 4T AC	125cc 4T AC	125cc 4T LC	125cc 4T LC	150cc 4T LC
	IM07071	IM07071								
	FZ00375	FZ00375	FZ00375	FZ00375	FZ00375	FZ00375	FZ00375			
	9926430	9926430	9926430			9926430		9915220	9915220	9915220
	9935740	9935740	9935740			9935740		9935660	9935660	9935660
	CT00742	CT00742								
	FZ00386	FZ00386	FZ00386	FZ00386	FZ00386	FZ00386	FZ00386			
								AA00815	AA00815	AA00815
	9917640	9917640				9917640		9916710		9916710
	MC12103	MC12103								
MA00007	MA00007	MA00007	MA00007			MA00007		MA00007	MA00007	MA00007
	RE00019	RE00019			RE00019		RE00019	RE00026	RE00026	RE00026
								RL00006		RL00006
								RL00007		RL00007
9927830	9927830	9927830	9927830			9927830				

MAXI SCOOTER



Kymco	Kymco	Kymco	Kymco	Kymco	Kymco
B&W 150 EU2	B&W 250	B&W 250 EU2	Dink 125	Dink 125 EU3	Dink 150
03-04	00-00	03-03	97-98	06-07	97-98
150cc 4T LC	250cc 4T LC	250cc 4T LC	125cc 4T LC	125cc 4T LC	150cc 4T LC

ALBERO A CAMME						
ALBERO MOTORE		Sel. 1 Sel. 2		IM07057 IM07057		
BIELLA						
CAMPANA FRIZIONE				FZ00399 FZ00399		
CINGHIA DI TRASMISSIONE		Bando Mitsuboshi Altro	9915220 9935660	9922420	9922420 9915220 9935660	9915220 9935660
COLLETORE ASPIRAZIONE						
FILTRO OLIO						
FRIZIONE				FZ00400 FZ00400		
GRUPPO TERMICO		Standard Maggiorato				
KIT CUSCINETTI/PARAOLI DI BANCO		Serie				
KIT REVISIONE POMPA ACQUA			AA00815	AA00816	AA00816 AA00815	AA00815
MASSE CENTRIFUGHE PESO ORIGINALE				9916080	9916080 9916710	
MEMBRANA CARBURATORE		Tipo originale Adattabile				MC12103
MOLLA CONTRASTO VARIATORE						
MOTORINO D'AVVIAMENTO			MA00007		MA00007	MA00027 MA00007
REGOLATORE DI TENSIONE			RE00026	RE00026	RE00026	RE00028 RE00026
RUOTA LIBERA		Complete RL + flangia RL nuda Ingranaggio Flangia				
SERIE DISCHI FRIZIONE						
STATORE						
VARIATORE VARIOTOP TPR				9923670		

MAXI SCOOTER

Kymco	Kymco	Kymco	Kymco	Kymco	Kymco	Kymco	Kymco	Kymco	Kymco	Kymco
Dink 200 IE EU3	Dink Classic 125	Dink Classic 125 EU2	Dink Classic 150	Dink Classic 150 EU2	Dink Classic 200	Dink LX 125	Dink LX 150	Downtown 125 I	Downtown 300I	Downtown ABS 300
06-07	02-02	03-03	02-02	03-03	04-04	98-00	98-00	09-09	09-09	10-10
200cc 4T LC	125cc 4T LC	125cc 4T LC	150cc 4T LC	150cc 4T LC	200cc 4T LC	125cc 4T LC	150cc 4T LC	125cc 4T LC	300cc 4T LC	300cc 4T LC
									FZ00408	FZ00408
9926420	9915220	9915220	9915220	9915220		9915220	9915220	9935310		
	9935660	9935660	9935660	9935660		9935660	9935660		9935320	
								FZ00411	FZ00409	FZ00409
	AA00815	AA00815	AA00815	AA00815	AA00815	AA00815	AA00815	AA00835	AA00833	AA00833
								9917640		
	MA00007	MA00007	MA00007	MA00007	MA00007	MA00007	MA00007			
	RE00026	RE00026	RE00026	RE00026	RE00026	RE00026	RE00026	RE00028	RE00028	RE00028
RL00008	RL00006	RL00006	RL00006	RL00006	RL00008	RL00006	RL00006	RL00006	RL00028	RL00028
	RL00007	RL00007	RL00007	RL00007		RL00007	RL00007			

MAXI SCOOTER



Kymco	Kymco	Kymco	Kymco	Kymco	Kymco
Downtown I 200	Downtown I 300	Downtown I ABS 300	G-DINK	Grand Dink 125	Grand Dink 125 EU2
10-10	11-11	11-11	12-12	01-02	03-04
200cc 4T LC	300cc 4T LC	300cc 4T LC	125cc 4T LC	125cc 4T LC	125cc 4T LC

ALBERO A CAMME						
ALBERO MOTORE		Sel. 1 Sel. 2				
BIELLA						
CAMPANA FRIZIONE			FZ00408	FZ00408	FZ00408	
CINGHIA DI TRASMISSIONE		Bando Mitsuboshi Altro				9915220 9935660 9935660
COLLETTORE ASPIRAZIONE						
FILTRO OLIO						
FRIZIONE			FZ00409	FZ00409	FZ00409	
GRUPPO TERMICO		Standard Maggiorato				
KIT CUSCINETTI/PARAOLI DI BANCO		Serie				
KIT REVISIONE POMPA ACQUA			AA00833	AA00833	AA00833	AA00815 AA00815
MASSE CENTRIFUGHE PESO ORIGINALE						9924320
MEMBRANA CARBURATORE		Tipo originale Adattabile				
MOLLA CONTRASTO VARIATORE						
MOTORINO D'AVVIAMENTO					MA00027	MA00027 MA00027
REGOLATORE DI TENSIONE			RE00028	RE00028	RE00028	RE00026 RE00026
RUOTA LIBERA		Complete RL + flangia RL nuda Ingranaggio Flangia		RL00028	RL00028	RL00006 RL00007
SERIE DISCHI FRIZIONE						
STATORE						
VARIATORE VARIOTOP TPR						

MAXI SCOOTER

Kymco	Kymco	Kymco	Kymco	Kymco	Kymco	Kymco	Kymco	Kymco	Kymco	Kymco
Grand Dink 150	Grand Dink 150 EU2	Grand Dink 250	Grand Dink 250 EU2	Heroism 125	Heroism 150	K-XCT I	Like 125	Like 200 IE	Like LX	Movie 125
01-02	03-04	01-02	03-04	95-97	95-97	12-14	09-09	09-09	12-12	99-00
150cc 4T LC	150cc 4T LC	250cc 4T LC	250cc 4T LC	125cc 4T AC	150cc 4T AC	125cc 4T LC	125cc 4T AC	200cc 4T AC	200cc 4T AC	125cc 4T AC
		IM07057	IM07057				IM07071			IM07071
		FZ00399	FZ00399	FZ00375	FZ00375	FZ00375	FZ00375	FZ00375	FZ00375	FZ00375
9915220	9915220	9922420	9922420	9915640	9915640		9926430	9926430	9926430	9915640
9935660	9935660						9935740	9935740	9935740	
		FZ00400	FZ00400	FZ00386	FZ00386	FZ00386	FZ00386	FZ00386	FZ00386	FZ00386
AA00815	AA00815	AA00816	AA00816							
		9916080	9916080	9917640						9917640
							MC12103		MC12103	
MA00027	MA00027			MA00007	MA00007		MA00007	MA00007	MA00007	MA00007
RE00026	RE00026	RE00026	RE00026	RE00026	RE00026		RE00019		RE00019	RE00013
RL00006		RL00008	RL00008							
RL00007		RL00009	RL00009	RL00024	RL00024					
		9923670						9927830	9927830	

MAXI SCOOTER



Kymco	Kymco	Kymco	Kymco	Kymco	Kymco
Movie 125 EU3	Movie 150 EU3	Movie XL 125	Movie XL 125 EU2	Movie XL 150	Movie XL 150 EU2
06-07	06-07	01-01	03-04	01-01	03-04
125cc 4T AC	150cc 4T AC	125cc 4T AC	125cc 4T AC	150cc 4T AC	150cc 4T AC

ALBERO A CAMME							
ALBERO MOTORE		Sel. 1 Sel. 2	IM07071		IM07071	IM07071	IM07071
BIELLA							
CAMPANA FRIZIONE			FZ00375	FZ00375	FZ00375	FZ00375	FZ00375
CINGHIA DI TRASMISSIONE		Bando	9926430	9926430	9926430	9926430	9926430
		Mitsuboshi	9935740	9935740	9935740	9935740	9935740
		Altro					
COLLETTORE ASPIRAZIONE							
FILTRO OLIO							
FRIZIONE			FZ00386	FZ00386	FZ00386	FZ00386	FZ00386
GRUPPO TERMICO		Standard					
		Maggiorato					
KIT CUSCINETTI/PARAOLI DI BANCO		Serie					
KIT REVISIONE POMPA ACQUA							
MASSE CENTRIFUGHE PESO ORIGINALE							
MEMBRANA CARBURATORE		Tipo originale					
		Adattabile	MC12103	MC12103		MC12103	
MOLLA CONTRASTO VARIATORE							
MOTORINO D'AVVIAMENTO			MA00007	MA00007		MA00007	MA00007
REGOLATORE DI TENSIONE			RE00013	RE00013	RE00013	RE00013	RE00013
RUOTA LIBERA		Complete					
		RL + flangia	RL00025	RL00025			
		RL nuda					
		Ingranaggio	RL00024	RL00024			
Flangia							
SERIE DISCHI FRIZIONE							
STATORE							
VARIATORE VARIOTOP TPR			9927830				

MAXI SCOOTER

Kymco	Kymco	Kymco	Kymco	Kymco	Kymco	Kymco	Kymco	Kymco	Kymco	Kymco
People 125	People 125 EU2	People 125 EU3	People 125 EU3	People 150	People 150 EU2	People EU3	People GTI 125	People GTI 200	People GTI 300	People GTI 300
99-00	03-03	07-07	08-08	99-00	03-03	11-11	10-10	10-10	10-10	11-11
125cc 4T AC	125cc 4T AC	125cc 4T AC	125cc 4T AC	150cc 4T AC	150cc 4T AC	125cc 4T AC	125cc 4T LC	200cc 4T LC	300cc 4T LC	300cc 4T LC
IM07071	IM07071	IM07071	IM07071	IM07071	IM07071	IM07071				
FZ00375		FZ00375	FZ00375	FZ00375	FZ00375	FZ00375		FZ00408	FZ00408	FZ00408
9926430	9926430	9926430	9926430	9926430	9926430	9926430				
9935740	9935740	9935740	9935740	9935740	9935740	9935740		9935330		
FZ00386	FZ00386	FZ00386	FZ00386	FZ00386	FZ00386	FZ00386		FZ00409	FZ00409	FZ00409
								AA00833	AA00833	AA00833
9917640	9917640	9917640	9917640			9917640	9917640			
	MC12103	MC12103	MC12103		MC12103	MC12103				
MA00007	MA00007	MA00007	MA00007	MA00007	MA00007	MA00007				
RE00013	RE00013	RE00013	RE00013	RE00013	RE00013		RE00028	RE00028	RE00028	RE00028
RL00025		RL00025	RL00025	RL00025				RL00028	RL00028	RL00028
RL00024		RL00024	RL00024	RL00024						
9927830		9927830	9927830	9927830						

MAXI SCOOTER



Kymco	Kymco	Kymco	Kymco	Kymco	Kymco
People GTI 300 ABS	People GTI 300 ABS	People LC 250	People ONE I	People S 125	People S 200
12-12	14-14	03-04	13-13	05-05	05-05
300cc 4T LC	300cc 4T LC	250cc 4T LC	125cc 4T AC	125cc 4T AC	200cc 4T AC

ALBERO A CAMME							
ALBERO MOTORE		Sel. 1 Sel. 2		IM07057	IM07071		
BIELLA							
CAMPANA FRIZIONE			FZ00399	FZ00375	FZ00375	FZ00375	
CINGHIA DI TRASMISSIONE		Bando Mitsuboshi Altro			9926430 9935740	9926430 9935740	
COLLETTORE ASPIRAZIONE							
FILTRO OLIO							
FRIZIONE			FZ00400	FZ00386	FZ00386	FZ00386	
GRUPPO TERMICO		Standard Maggiorato					
KIT CUSCINETTI/PARAOLI DI BANCO		Serie					
KIT REVISIONE POMPA ACQUA			AA00816				
MASSE CENTRIFUGHE PESO ORIGINALE			9916080		9917640	9917640	
MEMBRANA CARBURATORE		Tipo originale Adattabile			MC12103	MC12103	
MOLLA CONTRASTO VARIATORE							
MOTORINO D'AVVIAMENTO					MA00007	MA00007	
REGOLATORE DI TENSIONE			RE00028	RE00028	RE00026	RE00019	
RUOTA LIBERA		Complete					
		RL + flangia		RL00008		RL00025	RL00025
		RL nuda					
		Ingranaggio		RL00009		RL00024	RL00024
Flangia							
SERIE DISCHI FRIZIONE							
STATORE							
VARIATORE VARIOTOP TPR			9923670		9927830		

MAXI SCOOTER

Kymco	Kymco	Kymco	Kymco	Kymco	Kymco	Kymco	Kymco	Kymco	Kymco	Kymco
People S 200 I	People S 250	People S 250 I	People S 300 I	People S DD EU3 125	Super 8 125	Super 8 125	Vivio 125	Vivio 150	Xciting 250	Xciting 250 I
07-07	06-06	07-07	08-08	07-08	08-08	09-09	00-00	00-00	05-05	06-07
200cc 4T AC	250cc 4T LC	250cc 4T LC	300cc 4T LC	125cc 4T AC	125cc 4T AC	125cc 4T AC	125cc 4T AC	150cc 4T AC	250cc 4T LC	250cc 4T LC
			(BB60)		(KL25)	(KL25)				
	IM07057	IM07057		IM07071	IM07071	IM07071	IM07071	IM07071	IM07057	IM07057
FZ00375	FZ00399			FZ00375	FZ00375	FZ00375	FZ00375	FZ00375		FZ00399
9926430				9926430	9926430	9926430	9915640	9915640		
9935740	9935280			9935740	9935740	9935740				9935300
					CT00742	CT00742				
FZ00386	FZ00400	FZ00400	FZ00400	FZ00386	FZ00386	FZ00386	FZ00386	FZ00386	FZ00400	FZ00400
	AA00816	AA00816	AA00816						AA00816	AA00816
9917640	9916080	9916080	9932390	9917640	9917640	9917640	9917640		9916080	9916080
				MC12103	MC12103					
MA00007				MA00007	MA00007	MA00007	MA00007	MA00007		
RE00026		RE00028	RE00028	RE00019	RE00019	RE00019	RE00013	RE00013	RE00026	RE00028
	RL00028	RL00028	RL00028		RL00025	RL00025	RL00025	RL00025	RL00028	RL00028
	RL00031	RL00031	RL00031		RL00024	RL00024	RL00024	RL00024	RL00031	RL00031
	9923670	9923670			9927830	9927830	9927830	9927830	9923670	9923670

MAXI SCOOTER



Kymco	Kymco	Kymco	Kymco	Kymco	Kymco
Xciting 300 I	Xciting 400 I	Xciting 400 I	Xciting 400 I ABS	Xciting 400 I ABS	Xciting 500
08-08	13-13	15-15	14-14	15-15	05-05
300cc 4T LC	400cc 4T LC	400cc 4T LC	400cc 4T LC	400cc 4T LC	500cc 4T LC

ALBERO A CAMME									
ALBERO MOTORE		Sel. 1 Sel. 2							
BIELLA									
CAMPANA FRIZIONE			FZ00399						
CINGHIA DI TRASMISSIONE		Bando Mitsuboshi Altro	9929770						9935290
COLLETTORE ASPIRAZIONE									
FILTRO OLIO									
FRIZIONE			FZ00400						
GRUPPO TERMICO		Standard Maggiorato							
KIT CUSCINETTI/PARAOLI DI BANCO		Serie							
KIT REVISIONE POMPA ACQUA			AA00816	AA00837	AA00837	AA00837	AA00837	AA00837	
MASSE CENTRIFUGHE PESO ORIGINALE			9932390						
MEMBRANA CARBURATORE		Tipo originale Adattabile							
MOLLA CONTRASTO VARIATORE									
MOTORINO D'AVVIAMENTO									
REGOLATORE DI TENSIONE			RE00028						RE00028
RUOTA LIBERA		Complete							
		RL + flangia	RL00028						RL00027
		RL nuda							
		Ingranaggio	RL00031						RL00026
Flangia									
SERIE DISCHI FRIZIONE									
STATORE									
VARIATORE VARIOTOP TPR				9932860	9932860	9932860	9932860	9932860	

MAXI SCOOTER



Malaguti	Malaguti	Malaguti	Malaguti	Malaguti	Malaguti
Centro 125 IE EU3	Centro 160 IE EU3	Centro SL 125	Centro SL 125 IE EU3	Centro SL 160	Centro SL 160 IE EU3
08-09	08-09	11-11	09-10	11-11	09-10
125cc 4T LC	160cc 4T LC	125cc 4T LC	125cc 4T LC	160cc 4T LC	160cc 4T LC

ALBERO A CAMME						
ALBERO MOTORE		Sel. 1				
		Sel. 2				
BIELLA						
CAMPANA FRIZIONE		FZ00375	FZ00375	FZ00375		FZ00375
CINGHIA DI TRASMISSIONE		Bando				
		Mitsuboshi	9935770	9935770	9935770	9935770
		Altro	9923140	9923140	9923140	9923140
COLLETTORE ASPIRAZIONE						
FILTRO OLIO						
FRIZIONE		FZ00386	FZ00386	FZ00386		FZ00386
GRUPPO TERMICO		Standard				
		Maggiorato				
KIT CUSCINETTI/PARAOLI DI BANCO		Serie				
KIT REVISIONE POMPA ACQUA						
MASSE CENTRIFUGHE PESO ORIGINALE						9924320
MEMBRANA CARBURATORE		Tipo originale				
		Adattabile				
MOLLA CONTRASTO VARIATORE						
MOTORINO D'AVVIAMENTO		MA00022	MA00022	MA00022	MA00022	MA00022
REGOLATORE DI TENSIONE						
RUOTA LIBERA		Complete				
		RL + flangia				
		RL nuda				
		Ingranaggio				
		Flangia				
SERIE DISCHI FRIZIONE						
STATORE						
VARIATORE VARIOTOP TPR						

MAXI SCOOTER



Malaguti	Malaguti	Malaguti	Malaguti	Malaguti	Malaguti
F18 Warrior 150	Madison 125	Madison 3 125	Madison 3 250	Madison K 400	Madison R 180
00-02	99-01	06-09	06-09	02-02	01-02
150cc 4T LC	125cc 4T LC	125cc 4T LC	250cc 4T LC	400cc 4T LC	180cc 4T LC
Kymco	Minarelli YP	Piaggio	Piaggio	Morini	Piaggio

ALBERO A CAMME						
ALBERO MOTORE		Sel. 1		IM07045		
		Sel. 2				
BIELLA						
CAMPANA FRIZIONE				FZ00395	FZ00395	FZ00395
CINGHIA DI TRASMISSIONE		Bando	9915220	9915380		
		Mitsuboshi	9935660	9935700		
		Altro				
COLLETTORE ASPIRAZIONE				CT00730		
FILTRO OLIO				FO07515	FO07515	FO07515
FRIZIONE				FZ00371	FZ00378	FZ00382
GRUPPO TERMICO		Standard				
		Maggiorato		9929380		
KIT CUSCINETTI/PARAOLI DI BANCO		Serie		KK01010		
KIT REVISIONE POMPA ACQUA				AA00805		
MASSE CENTRIFUGHE PESO ORIGINALE				9915270		9922390
MEMBRANA CARBURATORE		Tipo originale		MC12000		
		Adattabile		MC12100		
MOLLA CONTRASTO VARIATORE				9929170		
MOTORINO D'AVVIAMENTO			MA00007	MA00017		
REGOLATORE DI TENSIONE						
RUOTA LIBERA		Complete				
		RL + flangia		RL00002		
		RL nuda				
		Ingranaggio			RL00023	
		Flangia				
SERIE DISCHI FRIZIONE						
STATORE						
VARIATORE VARIOTOP TPR				9923550	9923600	9923650
					9922430	9923650

MAXI SCOOTER

Malaguti	Malaguti	Malaguti	Malaguti	Malaguti	Malaguti	Malaguti	Malaguti	Malaguti	Malaguti	Malaguti
Madison R Restyling 125	Madison R Rest. 125 EU2	Madison RS 250	Madison S Restyling 200	Madison S 250	Madison T 150	Password 250	Password 250 EU3	Phantom Max 125	Phantom Max 200	Phantom Max 250
02-02	03-04	04-04	02-02	99-01	99-01	05-06	07-08	03-03	03-03	04-04
125cc 4T LC	125cc 4T LC	250cc 4T LC	200cc 4T LC	250cc 4T LC	150cc 4T LC	250cc 4T LC	250cc 4T LC	125cc 4T LC	200cc 4T LC	250cc 4T LC
Minarelli YP	Minarelli YP	Piaggio M237M	Piaggio	Minarelli YP	Minarelli YP	Minarelli YP	Minarelli YP	Minarelli YP	Piaggio	Piaggio M361M
IM07045	IM07045			IM07054		IM07054	IM07054	IM07045		
				IM07037		IM07037	IM07037			
		FZ00395	FZ00377	FZ00397		FZ00397	FZ00397		FZ00395	FZ00395
9915380	9915380			9915800	9915380			9915380		
9935700	9935700			9935710	9935700	9925600	9925600	9935700		
CT00730					CT00730			CT00730		
		FO07515	FO07515						FO07515	FO07515
FZ00371	FZ00371	FZ00382	FZ00378	FZ00388	FZ00401	FZ00388	FZ00388	FZ00371	FZ00378	FZ00382
				9926850		9926850	9926850			
9929380	9929380				9929380			9929380		
KK01010	KK01010			KK01007	KK01010	KK01007	KK01007	KK01010		
AA00805	AA00805			AA00806	AA00805	AA00806	AA00806	AA00805		
9915270	9915270			9918020		9918060	9918060	9915270		
MC12000	MC12001			MC12001	MC12000			MC12000		
MC12100	MC12101			MC12101	MC12100			MC12100		
9929170	9929170			9929870	9929170	9929870	9929870	9929170		
MA00017	MA00017			MA00010	MA00017	MA00010	MA00010	MA00017		
RL00002	RL00002	RL00021		RL00010	RL00002	RL00010	RL00010	RL00002		RL00021
		RL00023		RL00011		RL00011	RL00011			RL00023
9923550	9923550	9923650	9923650	9931790	9923550	9931790		9923550	9923650	9923650

MAXI SCOOTER



Malaguti	Malaguti	Malaguti	Mbk	Mbk	Mbk
Spider Max 500 GT	Spider Max 500 GT EU3	Spider Max RS 500	Booster 100	Cityliner 125 EU3	Doodo 125
04-05	06-06	08-08	99-01	08-10	00-00
500cc 4T LC	500cc 4T LC	500cc 4T LC	100cc 2T AC	125cc 4T-4V LC	125cc 4T LC
Piaggio	Piaggio M341M	Piaggio		Minarelli	Minarelli YP

ALBERO A CAMME						9927230			
ALBERO MOTORE		Sel. 1					IM07072	IM07045	
		Sel. 2							
BIELLA									
CAMPANA FRIZIONE			FZ00384	FZ00384	FZ00384				
CINGHIA DI TRASMISSIONE		Bando						9915380	
		Mitsuboshi	9927630	9927630	9927630		9925280	9935700	
		Altro							
COLLETTORE ASPIRAZIONE								CT00730	
FILTRO OLIO							FO07523		
FRIZIONE			FZ00383	FZ00383	FZ00383			FZ00371	
GRUPPO TERMICO		Standard					9932700		
		Maggiorato					9925180	9929380	
KIT CUSCINETTI/PARAOLI DI BANCO		Serie						KK01010	
KIT REVISIONE POMPA ACQUA							AA00823	AA00805	
MASSE CENTRIFUGHE PESO ORIGINALE			9922330					9915270	
MEMBRANA CARBURATORE		Tipo originale						MC12000	
		Adattabile							MC12100
MOLLA CONTRASTO VARIATORE			9926780	9926780	9926780	9914470	9926760	9929170	
MOTORINO D'AVVIAMENTO							MA00028	MA00017	
REGOLATORE DI TENSIONE									
RUOTA LIBERA		Complete							
		RL + flangia	RL00021	RL00021	RL00021		RL00034	RL00002	
		RL nuda							
		Ingranaggio	RL00023	RL00023	RL00023		RL00035		
Flangia									
SERIE DISCHI FRIZIONE									
STATORE								ST00002	
VARIATORE VARIOTOP TPR			9923250	9923250	9923250		9925020	9923550	

MAXI SCOOTER

Mbk	Mbk	Mbk	Mbk	Mbk	Mbk	Mbk	Mbk	Mbk	Mbk	Mbk
Dodo 150	Flame F 125	Flame R 125	Flame T 125	Kilibre 300	Nitro 100	Ovetto 100	Skycruiser 125	Skyliner 125	Skyliner 125	Skyliner 150
01-02	00-00	96-99	95-99	03-06	00-02	99-02	07-07	98-00	01-02	00-00
150cc 4T LC	125cc 4T AC	125cc 4T AC	125cc 4T AC	300cc 4T LC	100cc 2T AC	100cc 2T AC	125cc 4T-4V LC	125cc 4T LC	125cc 4T LC	150cc 4T LC
Minarelli YP				Minarelli YP	Minarelli	Minarelli	Minarelli	Minarelli YP	Minarelli YP	Minarelli YP
							9927230			
							IM07072	IM07045	IM07045	
				IM07037						
				FZ00397						
9915380	9931550	9931550	9931550					9915380	9915380	9915380
9935700				9925600			9925280	9935700	9935700	9935700
CT00730			CT00730					CT00730	CT00730	CT00730
							FO07523			
FZ00401				FZ00388			FZ00401	FZ00371	FZ00371	FZ00401
							9932700			
9929380							9925180	9929380	9929380	9929380
KK01010				KK01007				KK01010	KK01010	KK01010
AA00805				AA00806			AA00823	AA00805	AA00805	AA00805
				9918020				9915270	9915270	
MC12000				MC12001				MC12000	MC12000	
MC12100				MC12101				MC12100	MC12100	
9929170					9914470	9914470	9926760	9929170	9929170	9929170
MA00017				MA00010			MA00028	MA00017	MA00017	MA00017
RE00020					RE00014			RE00020	RE00020	RE00020
RL00002			RL00002	RL00010			RL00034	RL00002	RL00002	RL00002
				RL00011			RL00035			
ST00002								ST00002	ST00002	ST00002
9923550							9925020	9923550	9923550	9923550

MAXI SCOOTER



Mbk	Mbk	Mbk	Mbk	Mbk	Mbk
Skyliner 150	Skyliner 250	Skyliner 250	Skyliner 250 ABS	Skyliner E 125	Skyliner E 180
01-02	00-01	02-03	03-03	03-03	03-03
150cc 4T LC	250cc 4T LC	250cc 4T LC	250cc 4T LC	125cc 4T LC	180cc 4T LC
Minarelli YP	Minarelli YP	Minarelli YP	Minarelli YP	Minarelli YP	Minarelli YP

ALBERO A CAMME						
ALBERO MOTORE		Sel. 1		IM07054	IM07054	IM07054
		Sel. 2				
BIELLA				IM07037	IM07037	IM07037
CAMPANA FRIZIONE				FZ00397	FZ00397	FZ00397
CINGHIA DI TRASMISSIONE		Bando	9915380	9915800	9915800	9915800
		Mitsuboshi	9935700	9935710	9935710	9935710
		Altro				
COLLETTORE ASPIRAZIONE			CT00730			CT00729
FILTRO OLIO						
FRIZIONE			FZ00401	FZ00388	FZ00388	FZ00388
GRUPPO TERMICO		Standard		9926850	9926850	9926850
		Maggiorato	9929380			9929380
KIT CUSCINETTI/PARAOLI DI BANCO		Serie	KK01010	KK01007	KK01007	KK01007
KIT REVISIONE POMPA ACQUA			AA00805	AA00806	AA00806	AA00806
MASSE CENTRIFUGHE PESO ORIGINALE				9918060	9918060	9918060
MEMBRANA CARBURATORE		Tipo originale		MC12001	MC12001	MC12001
		Adattabile		MC12101	MC12101	MC12101
MOLLA CONTRASTO VARIATORE			9929170	9929870	9929870	9929870
MOTORINO D'AVVIAMENTO			MA00017	MA00010	MA00010	MA00010
REGOLATORE DI TENSIONE			RE00020			RE00030
RUOTA LIBERA		Complete				
		RL + flangia	RL00002	RL00010	RL00010	RL00010
		RL nuda				
		Ingranaggio		RL00011	RL00011	RL00011
		Flangia				
SERIE DISCHI FRIZIONE						
STATORE			ST00002			ST00002
VARIATORE VARIOTOP TPR			9923550	9931790	9931790	9931790

MAXI SCOOTER

Mbk	Mbk	Peugeot	Peugeot	Peugeot	Peugeot	Peugeot	Peugeot	Peugeot	Piaggio	Piaggio	Piaggio
Thunder 125	Thunder 150	Geopolis 250 IE EU3	Geopolis 400 IE EU3	Geopolis 500 IE EU3	Satelis 250 EU3	Satelis 400 EU3	Satelis 500 EU3	Beverly 125	Beverly 125 EU3	Beverly 125 EURO 3 MIC	
01-02	01-02	-00	-00	-00	-00	-00	-00	01-03	07-08	07-07	
125cc 4T LC	150cc 4T LC	250cc 4T-4V LC	400cc 4T-4V LC	500cc 4T-4V LC	250cc 4T LC	400cc 4T LC	500cc 4T LC	125cc 4T LC	125cc 4T LC	125cc 4T LC	
Minarelli YP	Minarelli YP	Piaggio	Piaggio	Piaggio	Piaggio	Piaggio	Piaggio				
IM07045								IM070701	IM070701		
								IM070702	IM070702		
			FZ00384	FZ00384		FZ00384	FZ00384	FZ00377	FZ00395		
9915380	9915380										
9935700	9935700		9927630	9927630		9927630	9927630	9928540	9928540	9928540	
						9935400					
CT00730	CT00730							CT00734			
		FO07515			FO07515			FO07515	FO07515	FO07515	
FZ00371	FZ00401		FZ00383	FZ00383		FZ00383	FZ00383	FZ00396	FZ00396		
9929380	9929380										
KK01010	KK01010										
AA00805	AA00805							AA00817	AA00826	AA00826	
9915270			9924530			9924530	9924530				
MC12000	MC12000							MC12002			
MC12100	MC12100										
9929170	9929170		9926780	9926780		9926780	9926780				
MA00017	MA00017							MA00012	MA00012	MA00012	
								RE00011	RE00011	RE00011	
RL00002	RL00002		RL00021	RL00021		RL00021	RL00021				
			RL00023	RL00023		RL00023	RL00023	RL00022	RL00022	RL00022	
ST00002	ST00002										
9923550	9923550	9923650	9924760	9923250	9923650	9924760	9923250	9923600	9923600	9923600	

MAXI SCOOTER



Piaggio	Piaggio	Piaggio	Piaggio	Piaggio	Piaggio
Beverly 125 EURO 3 SPORT	Beverly 125 RST 4T 4V IE EU3	Beverly 125 Tourer EU3	Beverly 200	Beverly 250	Beverly 250 CRUISER
07-08	10-15	07-10	01-03	06-07	07-09
125cc 4T LC	125cc 4T LC	125cc 4T LC	200cc 4T LC	250cc 4T LC	250cc 4T LC
				Piaggio M285M	

ALBERO A CAMME						
ALBERO MOTORE		Sel. 1		IM070701		
		Sel. 2		IM070702		
BIELLA						
CAMPANA FRIZIONE				FZ00395	FZ00377	FZ00395
CINGHIA DI TRASMISSIONE		Bando				
		Mitsuboshi	9928540	9928540	9928540	9935450
		Altro				
COLLETTORE ASPIRAZIONE						CT00735
FILTRO OLIO			FO07515	FO07515	FO07515	FO07515
FRIZIONE				FZ00396		FZ00382
GRUPPO TERMICO		Standard				
		Maggiorato				
KIT CUSCINETTI/PARAOLI DI BANCO		Serie				
KIT REVISIONE POMPA ACQUA			AA00826	AA00826	AA00826	AA00817
					AA00828	AA00828
MASSE CENTRIFUGHE PESO ORIGINALE					9932790	9931880
MEMBRANA CARBURATORE		Tipo originale				
		Adattabile				
MOLLA CONTRASTO VARIATORE						
MOTORINO D'AVVIAMENTO			MA00012		MA00012	MA00016
REGOLATORE DI TENSIONE			RE00011		RE00011	RE00011
						RE00004
RUOTA LIBERA		Complete				
		RL + flangia		RL00041		RL00041
		RL nuda				
		Ingranaggio	RL00022	RL00022	RL00022	RL00023
		Flangia				
SERIE DISCHI FRIZIONE						
STATORE						ST00023
VARIATORE VARIOTOP TPR			9923600	9923600	9923600	9923650
					9923650	

MAXI SCOOTER

Piaggio	Piaggio	Piaggio	Piaggio	Piaggio	Piaggio	Piaggio	Piaggio	Piaggio	Piaggio	Piaggio
Beverly 250 EURO 3 MIC	Beverly 250 SPORT	Beverly 250 Tourer EU3	Beverly 250 ie EU3	Beverly 300 RST 4T 4V IE EU3	Beverly 350 4T 4V IE EU3	Beverly 400 EU3	Beverly 500	Beverly 500	Beverly 500 ie EU3	Beverly Cruiser 500
07-07	06-08	07-09	06-08	10-15	11-13	06-07	02-04	05-06	06-08	07-11
250cc 4T LC	250cc 4T LC	250cc 4T LC	250cc 4T LC	300cc 4T LC	350cc 4T LC	400cc 4T LC	500cc 4T LC	500cc 4T LC	500cc 4T LC	500cc 4T LC
						Piaggio M345M		Piaggio	Piaggio M343M	Piaggio Master
		FZ00395	FZ00395			FZ00384	FZ00384	FZ00384	FZ00384	
9927640	9927640	9927640	9927640	9927640	9935490	9927630	9927630	9927630	9927630	
FO07515	FO07515	FO07515	FO07515	FO07515						
							FZ00383	FZ00383	FZ00383	FZ00383
AA00828	AA00828	AA00828	AA00828	AA00828	AA00829	AA00824			AA00824	AA00824
	9931880	9931880	9931880	9931880		9924530	9922330			
						9926780	9926780	9926780	9926780	9926780
		MA00016	MA00016	MA00016						
	RE00004	RE00004	RE00004			RE00004	RE00004	RE00004	RE00004	RE00004
RL00041	RL00041	RL00041	RL00041	RL00021	RL00021	RL00021	RL00021	RL00021	RL00021	RL00021
RL00023	RL00023	RL00023	RL00023	RL00023	RL00023	RL00023	RL00023	RL00023	RL00023	RL00023
					9931020					
ST00023	ST00023	ST00023	ST00023			ST00005	ST00005	ST00005	ST00005	
			9923650			9924760	9923250	9923250	9923250	9923250

MAXI SCOOTER



Piaggio	Piaggio	Piaggio	Piaggio	Piaggio	Piaggio
Beverly RST 125	Beverly RST 125	Beverly RST 250	Beverly Tourer 300 EU3	Beverly Tourer 400 EU3	Carnaby 125
04-05	05-07	04-05	09-10	08-10	07-10
125cc 4T LC	125cc 4T LC	250cc 4T LC	300cc 4T LC	400cc 4T LC	125cc 4T LC
M28400			Piaggio M28MM	Piaggio M349M	Leader M28FM

ALBERO A CAMME							
ALBERO MOTORE		Sel. 1		IM070701		IM070701	
		Sel. 2		IM070702		IM070702	
BIELLA							
CAMPANA FRIZIONE			FZ00395	FZ00395	FZ00395	FZ00384	
CINGHIA DI TRASMISSIONE		Bando					
		Mitsuboshi	9928540	9928540	9927640	9927640	9927630
		Altro					
COLLETTORE ASPIRAZIONE			CT00735	CT00735	CT00735		
FILTRO OLIO			FO07515	FO07515	FO07515	FO07515	
FRIZIONE			FZ00396	FZ00396		FZ00396	
GRUPPO TERMICO		Standard					
		Maggiorato					
KIT CUSCINETTI/PARAOLI DI BANCO		Serie					
KIT REVISIONE POMPA ACQUA			AA00817	AA00826	AA00828	AA00824	
MASSE CENTRIFUGHE PESO ORIGINALE					9931880		
MEMBRANA CARBURATORE		Tipo originale					
		Adattabile					
MOLLA CONTRASTO VARIATORE					9926780		
MOTORINO D'AVVIAMENTO			MA00012	MA00012	MA00016	MA00016	
REGOLATORE DI TENSIONE			RE00011	RE00011	RE00011	RE00004	
RUOTA LIBERA		Complete					
		RL + flangia		RL00021	RL00021	RL00021	
		RL nuda					
		Ingranaggio	RL00022	RL00022	RL00023	RL00023	RL00023
		Flangia					
SERIE DISCHI FRIZIONE							
STATORE				ST00023			
VARIATORE VARIOTOP TPR			9923600	9923600	9923650	9923650	

MAXI SCOOTER

Piaggio	Piaggio	Piaggio	Piaggio	Piaggio	Piaggio	Piaggio	Piaggio	Piaggio	Piaggio	Piaggio
Carnaby 200	Carnaby 250	Carnaby Cruiser 300	Diesis 100	Fly 100	Fly 100	Fly 125	Fly 125 EU3	Fly 125 EU3	Fly 150	Fly 150 EU3
07-08	08-08	09-12	01-01	06-07	08-08	05-07	07-07	08-11	05-07	08-11
200cc 4T LC	250cc 4T LC	300cc 4T LC	100cc 2T AC	100cc 4T AC	100cc 4T AC	125cc 4T AC	125cc 4T AC	125cc 4T AC	150cc 4T AC	150cc 4T AC
Leader M601M		Piaggio M604M				Leader M422M			Leader M422M	
						IM070701	IM070701	IM070701	IM070701	IM070701
						IM070702	IM070702	IM070702	IM070702	IM070702
FZ00395		FZ00395				FZ00395			FZ00395	
9935450	9927640	9927640		9935440	9935440	9927650	9927650	9927650	9927650	9927650
						CT00736	CT00736	CT00736	CT00736	CT00736
FO07515	FO07515	FO07515				FO07515	FO07515	FO07515	FO07515	FO07515
FZ00378	FZ00382					FZ00378	FZ00418		FZ00378	FZ00418
AA00826	AA00828	AA00828								
9932790	9931880	9931880								
MA00012	MA00016	MA00016	MA00015			MA00012	MA00012	MA00012	MA00012	MA00012
RE00011	RE00004	RE00004	RE00025	RE00018	RE00018	RE00011	RE00011	RE00011	RE00011	RE00011
	RL00041	RL00021								
RL00022	RL00023					RL00022	RL00022	RL00022	RL00022	RL00022
	ST00023	ST00023		ST00004	ST00004					
9923650	9923650	9923650				9923600			9923600	

MAXI SCOOTER



Piaggio	Piaggio	Piaggio	Piaggio	Piaggio	Piaggio
Free 100	Hexagon 125	Hexagon 150	Hexagon GT 250	Hexagon GTX 125	Hexagon GTX 180
02-03	94-97	94-97	98-00	00-00	00-00
100cc 4T AC	125cc 2T LC	150cc 2T LC	250cc 4T LC	125cc 4T LC	180cc 4T LC
			Motore Honda		

ALBERO A CAMME						
ALBERO MOTORE		Sel. 1				IM070701
		Sel. 2				IM070702
BIELLA						
CAMPANA FRIZIONE						FZ00395 FZ00377
CINGHIA DI TRASMISSIONE		Bando		9915360	9915350	9915410
		Mitsuboshi	9935440	9935680	9935670	9927650
		Altro				
COLLETTORE ASPIRAZIONE			CT00728	CT00728		CT00734
FILTRO OLIO						FO07515 FO07515
FRIZIONE						FZ00396 FZ00378
GRUPPO TERMICO		Standard				
		Maggiorato				
KIT CUSCINETTI/PARAOLI DI BANCO		Serie				
KIT REVISIONE POMPA ACQUA						AA00817 AA00817
MASSE CENTRIFUGHE PESO ORIGINALE						9932790
MEMBRANA CARBURATORE		Tipo originale				MC12002 MC12002
		Adattabile				
MOLLA CONTRASTO VARIATORE						
MOTORINO D'AVVIAMENTO						MA00012 MA00012
REGOLATORE DI TENSIONE			RE00018			RE00011
RUOTA LIBERA		Complete				
		RL + flangia				
		RL nuda				
		Ingranaggio				RL00022 RL00022
		Flangia				
SERIE DISCHI FRIZIONE						
STATORE			ST00004			
VARIATORE VARIOTOP TPR						9923600

MAXI SCOOTER

Piaggio	Piaggio	Piaggio	Piaggio	Piaggio	Piaggio	Piaggio	Piaggio	Piaggio	Piaggio	Piaggio
Hexagon LX 125	Hexagon LX4 125	Hexagon LXT180	Liberty 125	Liberty 125	Liberty 125 4T	Liberty 125 4T EU3	Liberty 125 4T EU3 Delivery - TNT	Liberty 125 4T Sport EU3	Liberty 125 Sport	Liberty 150
98-99	98-99	98-99	98-00	01-02	06-07	07-08	08-15	06-08	06-06	01-02
125cc 2T LC	125cc 4T AC	180cc 2T LC	125cc 4T AC	125cc 4T AC	125cc 4T AC	125cc 4T AC	125cc 4T AC	125cc 4T AC	125cc 4T AC	150cc 4T AC
				Leader						Leader
				IM070701	IM070701	IM070701	IM070701	IM070701	IM070701	IM070701
				IM070702	IM070702	IM070702	IM070702	IM070702	IM070702	IM070702
			FZ00395	FZ00395						FZ00395
9915360		9915340								
9935680	9935430	9935780	9935430	9927650	9927650	9927650	9927650	9927650	9927650	9927650
		CT00728	CT00739	CT00740	CT00736		CT00736		CT00736	
	FO07514		FO07514	FO07515	FO07515	FO07515	FO07515	FO07515	FO07515	FO07515
			FZ00396	FZ00396		FZ00418				FZ00378
		9922670								
			MC12002	MC12002						MC12002
	MA00013		MA00013	MA00012	MA00012	MA00012	MA00012	MA00012	MA00012	
	RE00012		RE00012	RE00011	RE00011	RE00011	RE00011	RE00011	RE00011	
			RL00022	RL00022	RL00022	RL00022	RL00022	RL00022	RL00022	RL00022
			9923600	9923600						9923600

MAXI SCOOTER



Piaggio	Piaggio	Piaggio	Piaggio	Piaggio	Piaggio
Liberty 150 4T EU3	Liberty 150 4T Sport EU3	Liberty 150 Moc 4T	Liberty 200	Liberty 200 4T EU3	Liberty 200 4T Sport EU3
08-08	08-08	09-13	06-06	06-08	06-07
150cc 4T AC	150cc 4T AC	150cc 4T AC	200cc 4T AC	200cc 4T AC	200cc 4T AC
					Leader

ALBERO A CAMME							
ALBERO MOTORE		Sel. 1	IM070701	IM070701	IM070701		
		Sel. 2	IM070702	IM070702	IM070702		
BIELLA							
CAMPANA FRIZIONE					FZ00395		FZ00395
CINGHIA DI TRASMISSIONE		Bando					
		Mitsuboshi	9927650	9927650	9927650		
		Altro					
COLLETTORE ASPIRAZIONE				CT00736	CT00736		
FILTRO OLIO			FO07515	FO07515	FO07515	FO07515	FO07515
FRIZIONE				FZ00418	FZ00378		
GRUPPO TERMICO		Standard					
		Maggiorato					
KIT CUSCINETTI/PARAOLI DI BANCO		Serie					
KIT REVISIONE POMPA ACQUA							
MASSE CENTRIFUGHE PESO ORIGINALE					9932790	9932790	9932790
MEMBRANA CARBURATORE		Tipo originale					
		Adattabile					
MOLLA CONTRASTO VARIATORE							
MOTORINO D'AVVIAMENTO			MA00012	MA00012	MA00012	MA00012	MA00012
REGOLATORE DI TENSIONE			RE00011	RE00011	RE00011	RE00011	RE00011
RUOTA LIBERA		Complete					
		RL + flangia					
		RL nuda					
		Ingranaggio	RL00022	RL00022	RL00022	RL00022	RL00022
		Flangia					
SERIE DISCHI FRIZIONE							
STATORE							
VARIATORE VARIOTOP TPR					9923650		9923650

MAXI SCOOTER

Piaggio	Piaggio	Piaggio	Piaggio	Piaggio	Piaggio	Piaggio	Piaggio	Piaggio	Piaggio	Piaggio
Liberty 200 Sport	Liberty 4T 2V Euro3	Liberty RST 125	Liberty RST 200	Liberty RST PTT 125	MP3 125	MP3 125 IE	MP3 125 IE Touring	MP3 125 Ibrido	MP3 125 Yourban ERL	MP3 250
06-06	09-12	04-05	04-04	05-11	06-08	08-09	11-12	09-10	11-11	06-08
200cc 4T AC	125cc 4T AC	125cc 4T AC	200cc 4T AC	125cc 4T AC	125cc 4T LC	125cc 4T LC	125cc 4T LC	125cc 4T LC	125cc 4T LC	250cc 4T LC
					Piaggio M631M					Quasar M472M
				IM070701	IM070701					
				IM070702	IM070702					
					FZ00395	FZ00395	FZ00395	FZ00395	FZ00395	FZ00395
	9927650	9927650		9927650	9927650	9927650	9927650	9927650	9927650	
CT00736	CT00736	CT00736	CT00736							
FO07515	FO07515	FO07515	FO07515	FO07515	FO07515	FO07515	FO07515	FO07515	FO07515	FO07515
					FZ00396	FZ00396		FZ00396		FZ00382
					AA00826					AA00828
9932790			9932790							
MA00012	MA00012	MA00012	MA00012		MA00012					MA00016
RE00011		RE00011	RE00011		RE00011	RE00004		RE00004		RE00004
						RL00041	RL00041	RL00041		RL00041
RL00022	RL00022	RL00022	RL00022	RL00022	RL00022	RL00023	RL00023	RL00023	RL00023	RL00023
						ST00023		ST00023		ST00023
		9923600	9923600		9923600	9923600	9923600	9923600	9923600	9923650

MAXI SCOOTER



Piaggio	Piaggio	Piaggio	Piaggio	Piaggio	Piaggio
MP3 250 LT	MP3 250 MIC	MP3 300 4T 4V IE LT Ibrido	MP3 300 IE LT	MP3 300 IE LT Touring	MP3 300 IE LT/Sport
08-09	08-09	10-11	10-11	11-13	11-14
250cc 4T LC	250cc 4T LC	300cc 4T LC	300cc 4T LC	300cc 4T LC	300cc 4T LC

ALBERO A CAMME						
ALBERO MOTORE		Sel. 1				
		Sel. 2				
BIELLA						
CAMPANA FRIZIONE		FZ00395	FZ00395	FZ00395	FZ00395	FZ00395
CINGHIA DI TRASMISSIONE		Bando				
		Mitsuboshi				
		Altro				
COLLETTORE ASPIRAZIONE						
FILTRO OLIO		FO07515	FO07515	FO07515	FO07515	FO07515
FRIZIONE		FZ00382	FZ00382	FZ00382	FZ00382	FZ00382
GRUPPO TERMICO		Standard				
		Maggiorato				
KIT CUSCINETTI/PARAOLI DI BANCO		Serie				
KIT REVISIONE POMPA ACQUA		AA00828	AA00828	AA00828	AA00828	AA00828
MASSE CENTRIFUGHE PESO ORIGINALE				9931880	9931880	9931880
MEMBRANA CARBURATORE		Tipo originale				
		Adattabile				
MOLLA CONTRASTO VARIATORE						
MOTORINO D'AVVIAMENTO		MA00016	MA00016			
REGOLATORE DI TENSIONE		RE00004	RE00004			
RUOTA LIBERA		Complete				
		RL + flangia	RL00041	RL00041	RL00021	RL00021
		RL nuda				
		Ingranaggio	RL00023	RL00023	RL00023	RL00023
		Flangia				
SERIE DISCHI FRIZIONE						
STATORE		ST00023	ST00023			
VARIATORE VARIOTOP TPR		9923650	9923650	9923650	9923650	9923650

MAXI SCOOTER

Piaggio	Piaggio	Piaggio	Piaggio	Piaggio	Piaggio	Piaggio	Piaggio	Piaggio	Piaggio	Piaggio
MP3 300 IE MIC	MP3 300 IE MIC	MP3 300 IE Touring	MP3 300 Yourban ERL	MP3 300 Yourban LT ERL	MP3 400	MP3 400 IE LT Touring	MP3 400 IE LT/Sport	MP3 400 MIC	MP3 400 RL Touring	MP3 500 LT Sport/Business
10-10	11-11	11-12	11-15	11-12	07-08	11-11	08-10	08-10	11-11	-
300cc 4T LC	300cc 4T LC	300cc 4T LC	300cc 4T LC	300cc 4T LC	400cc 4T LC	400cc 4T LC	400cc 4T LC	400cc 4T LC	400cc 4T LC	500cc 4T LC
					Piaggio M474M					
FZ00395	FZ00395	FZ00395	FZ00395	FZ00395	FZ00384	FZ00384	FZ00384	FZ00384	FZ00384	FZ00384
					9927630	9927630	9927630	9927630	9927630	9935500
FO07515	FO07515	FO07515	FO07515	FO07515						
FZ00382	FZ00382	FZ00382	FZ00382	FZ00382						
AA00828	AA00828	AA00828	AA00828	AA00828	AA00824	AA00824	AA00824	AA00824	AA00824	AA00824
9931880	9931880	9931880	9931880	9931880						
					9926780	9926780	9926780	9926780	9926780	9926780
					RE00004	RE00004	RE00004	RE00004	RE00004	RE00004
RL00021	RL00021	RL00021			RL00021	RL00021	RL00021	RL00021	RL00021	RL00021
RL00023	RL00023	RL00023	RL00023	RL00023	RL00023	RL00023	RL00023	RL00023	RL00023	RL00023
9923650	9923650	9923650	9923650	9923650	9924760	9924760	9924760	9924760	9924760	9923250

MAXI SCOOTER



Piaggio	Piaggio	Piaggio	Piaggio	Piaggio	Piaggio
MP3 500 RL Sport	Sfera	Skipper 125 LX	Skipper 150 LX	Skypper 125	Skypper 125 4T
-	95-97	98-99	98-99	94-97	00-02
500cc 4T LC	125cc 4T AC	125cc 2T AC	150cc 2T AC	125cc 2T AC	125cc 4T AC

ALBERO A CAMME						
ALBERO MOTORE		Sel. 1				IM070701
		Sel. 2				IM070702
BIELLA						
CAMPANA FRIZIONE		FZ00384				FZ00377
CINGHIA DI TRASMISSIONE		Bando	9915370	9915350	9915350	9915360
		Mitsuboshi	9935500	9935690	9935670	9935680
		Altro				9927650
COLLETTORE ASPIRAZIONE			CT00739			CT00728
FILTRO OLIO			FO07514			FO07515
FRIZIONE						FZ00396
GRUPPO TERMICO		Standard				
		Maggiorato				
KIT CUSCINETTI/PARAOLI DI BANCO		Serie				
KIT REVISIONE POMPA ACQUA		AA00824				
MASSE CENTRIFUGHE PESO ORIGINALE						
MEMBRANA CARBURATORE		Tipo originale				MC12002
		Adattabile				
MOLLA CONTRASTO VARIATORE		9926780				
MOTORINO D'AVVIAMENTO		MA00013				MA00012
REGOLATORE DI TENSIONE		RE00004	RE00009			RE00011
RUOTA LIBERA		Complete				
		RL + flangia	RL00021			
		RL nuda				
		Ingranaggio	RL00023			RL00022
		Flangia				
SERIE DISCHI FRIZIONE						
STATORE						
VARIATORE VARIOTOP TPR		9923250				9923600

MAXI SCOOTER

Piaggio	Piaggio	Piaggio	Piaggio	Piaggio	Piaggio	Piaggio	Piaggio	Piaggio	Piaggio	Piaggio
Skypper 150	Skypper 150 4T	Super Hexagon GTX 12 125	Super Hexagon GTX 12 180	Typhoon 125 4T 2V E3	Vespa ET4 125	Vespa ET4 125	Vespa ET4 150	Vespa GRAN-TURISMO 125	Vespa GRAN-TURISMO 125	Vespa GRANTURISMO 125 EU3
94-97	00-02	01-02	01-02	10-11	96-98	99-02	99-02	03-05	06-07	06-07
150cc 2T AC	150cc 4T AC	125cc 4T LC	180cc 4T LC	125cc 4T AC	125cc 4T AC	125cc 4T AC	150cc 4T AC	125cc 4T LC	125cc 4T LC	125cc 4T LC
						Leader	Leader	Piaggio M311M		Piaggio M314M
				IM070701		IM070701		IM070701	IM070701	IM070701
				IM070702		IM070702		IM070702	IM070702	IM070702
	FZ00377	FZ00377	FZ00377			FZ00377	FZ00377	FZ00395	FZ00395	FZ00395
9915350					9915370					
9935670	9927650	9927650		9927650	9935690	9927650	9927650	9927650	9927650	9927650
CT00728	CT00740	CT00734		CT00736	CT00739	CT00740	CT00740	CT00734	CT00735	CT00735
	FO07515	FO07515	FO07515	FO07515	FO07514	FO07515	FO07515	FO07515	FO07515	FO07515
	FZ00378	FZ00396	FZ00378	FZ00418		FZ00396	FZ00378	FZ00396	FZ00396	FZ00396
		AA00817	AA00817					AA00817	AA00826	AA00826
			9932790							
	MC12002				MC12002	MC12002	MC12002			
	MA00012	MA00012	MA00012	MA00012	MA00013	MA00012	MA00012	MA00012	MA00012	MA00012
		RE00011	RE00011	RE00011	RE00012	RE00011		RE00011	RE00011	RE00011
	RL00022	RL00022	RL00022	RL00022	RL00022	RL00022	RL00022	RL00022	RL00022	RL00022
	9923600	9923600	9923600		9923600	9923600	9923600	9923600	9923600	9923600

MAXI SCOOTER



Piaggio	Piaggio	Piaggio	Piaggio	Piaggio	Piaggio
Vespa GRAN-TURISMO 200	Vespa GRAN-TURISMO 200	Vespa GT 60 250 EU3	Vespa GTS 125 EU3	Vespa GTS 200 EU3	Vespa GTS 250
03-05	06-07	06-07	07-12	-00	05-16
200cc 4T LC	200cc 4T LC	250cc 4T LC	125cc 4T LC	200cc 4T LC	250cc 4T LC
			Piaggio M315M		

ALBERO A CAMME						
ALBERO MOTORE		Sel. 1			IM070701	
		Sel. 2			IM070702	
BIELLA						
CAMPANA FRIZIONE		FZ00377	FZ00395	FZ00395		FZ00377 FZ00395
CINGHIA DI TRASMISSIONE		Bando				
		Mitsuboshi			9927650	
		Altro				
COLLETTORE ASPIRAZIONE			CT00735			
FILTRO OLIO		FO07515	FO07515	FO07515	FO07515	FO07515
FRIZIONE		FZ00378		FZ00382	FZ00396	FZ00378 FZ00382
GRUPPO TERMICO		Standard				
		Maggiorato				
KIT CUSCINETTI/PARAOLI DI BANCO		Serie				
KIT REVISIONE POMPA ACQUA			AA00826	AA00828	AA00826	AA00828
MASSE CENTRIFUGHE PESO ORIGINALE			9932790	9932790		
MEMBRANA CARBURATORE		Tipo originale				
		Adattabile				
MOLLA CONTRASTO VARIATORE						
MOTORINO D'AVVIAMENTO			MA00012	MA00012	MA00016	MA00012 MA00016
REGOLATORE DI TENSIONE			RE00011	RE00011	RE00004	RE00011 RE00004
RUOTA LIBERA		Complete				
		RL + flangia		RL00041		RL00041
		RL nuda				
		Ingranaggio	RL00022	RL00022	RL00023	RL00022 RL00023
		Flangia				
SERIE DISCHI FRIZIONE						
STATORE				ST00023		ST00023
VARIATORE VARIOTOP TPR			9923650	9923650	9923650	9923650

MAXI SCOOTER

Piaggio	Piaggio	Piaggio	Piaggio	Piaggio	Piaggio	Piaggio	Piaggio	Piaggio	Piaggio	Piaggio
Vespa GTS 4T IE SUPER	Vespa GTS ABS 250	Vespa GTS IE Touring 300	Vespa GTS Super	Vespa GTS Super Sport	Vespa GTV 125	Vespa GTV 200 EU3	Vespa GTV 250	Vespa GTV 4T 4V IE 300	Vespa GTV 4T NAVY EU3 125	Vespa GTV 4T NAVY EU3 250
09-16	05-12	11-12	08-15	10-13	06-08	-00	06-09	10-13	08-08	07-07
125cc 4T LC	250cc 4T LC	300cc 4T LC	300cc 4T LC	300cc 4T LC	125cc 4T LC	200cc 4T LC	250cc 4T LC	300cc 4T LC	125cc 4T LC	250cc 4T LC
Piaggio M455M			Piaggio M454M							
					IM070701				IM070701	
					IM070702				IM070702	
FZ00395	FZ00395		FZ00395			FZ00377	FZ00395			
9927650					9927650				9927650	
					CT00735					
FO07515	FO07515	FO07515	FO07515	FO07515	FO07515		FO07515	FO07515	FO07515	FO07515
FZ00396	FZ00382				FZ00396	FZ00378	FZ00382		FZ00396	
	AA00828	AA00828	AA00828	AA00828	AA00826		AA00828	AA00828	AA00826	AA00828
		9931880	9931880	9931880				9931880		
MA00016	MA00016	MA00016	MA00016	MA00016	MA00012		MA00016	MA00016	MA00012	MA00016
	RE00004		RE00004		RE00011		RE00004		RE00011	RE00004
RL00041	RL00021	RL00021	RL00021	RL00021			RL00041	RL00021		RL00041
RL00023	RL00023	RL00023	RL00023	RL00023	RL00022		RL00023	RL00023	RL00022	RL00023
	ST00023						ST00023			ST00023
9923600	9923650		9923650		9923600	9923650	9923650		9923600	9923650

MAXI SCOOTER



Piaggio	Piaggio	Piaggio	Piaggio	Piaggio	Piaggio
Vespa GTV VIA MONTENAPOLEONE	Vespa LX 125	Vespa LX 150	Vespa LX 4T EU3 TOURING	Vespa LX 4T FL	Vespa LX 4T FL
10-10	05-06	05-06	10-11	09-09	09-09
300cc 4T LC	125cc 4T AC	150cc 4T AC	125cc 4T AC	125cc 4T AC	150cc 4T AC

ALBERO A CAMME						
ALBERO MOTORE		Sel. 1	IM070701	IM070701	IM070701	IM070701
		Sel. 2	IM070702	IM070702	IM070702	IM070702
BIELLA						
CAMPANA FRIZIONE		FZ00395	FZ00395	FZ00395	FZ00395	FZ00395
CINGHIA DI TRASMISSIONE		Bando				
		Mitsuboshi	9927650	9927650	9927650	9927650
		Altro				
COLLETTORE ASPIRAZIONE			CT00736	CT00736		
FILTRO OLIO		FO07515	FO07515	FO07515	FO07515	FO07515
FRIZIONE					FZ00418	
GRUPPO TERMICO		Standard				
		Maggiorato				
KIT CUSCINETTI/PARAOLI DI BANCO		Serie				
KIT REVISIONE POMPA ACQUA			AA00828			
MASSE CENTRIFUGHE PESO ORIGINALE			9931880			
MEMBRANA CARBURATORE		Tipo originale				
		Adattabile				
MOLLA CONTRASTO VARIATORE						
MOTORINO D'AVVIAMENTO			MA00016	MA00012	MA00012	MA00012
REGOLATORE DI TENSIONE				RE00011	RE00011	RE00011
RUOTA LIBERA		Complete				
		RL + flangia	RL00021			
		RL nuda				
		Ingranaggio	RL00023	RL00022	RL00022	RL00022
		Flangia				
SERIE DISCHI FRIZIONE						
STATORE			ST00023			
VARIATORE VARIOTOP TPR			9923600	9923600	9923600	9923600

MAXI SCOOTER

Piaggio	Piaggio	Piaggio	Piaggio	Piaggio	Piaggio	Piaggio	Piaggio	Piaggio	Piaggio	Piaggio
Vespa LX EU3	Vespa LX EU3	Vespa LX EU3 IE	Vespa LX EU3 IE	Vespa LX TOURING	Vespa LXV 4T EU3	Vespa LXV IE 4T	Vespa LXV NAVY EU3	Vespa S 4T 125 EU3	Vespa S 4T 150	Vespa S 4T IE & COLLEGE
06-08	06-08	09-10	09-11	10-12	06-09	10-12	07-08	07-08	08-09	09-11
150cc 4T AC	125cc 4T AC	125cc 4T AC	150cc 4T AC	150cc 4T AC	125cc 4T LC	125cc 4T LC	125cc 4T LC	125cc 4T AC	150cc 4T AC	125cc 4T AC
								Piaggio M444M	Piaggio M445M	
IM070701	IM070701	IM070701	IM070701	IM070701	IM070701	IM070701	IM070701	IM070701	IM070701	IM070701
IM070702	IM070702	IM070702	IM070702	IM070702	IM070702	IM070702	IM070702	IM070702	IM070702	IM070702
FZ00395	FZ00395	FZ00395	FZ00395		FZ00395	FZ00395	FZ00395	FZ00395		FZ00395
9927650	9927650	9927650	9927650	9927650	9927650	9927650	9927650	9927650	9927650	9927650
CT00736	CT00736				CT00736					
FO07515	FO07515	FO07515	FO07515	FO07515	FO07515	FO07515	FO07515	FO07515	FO07515	FO07515
			FZ00418	FZ00418		FZ00418		FZ00418	FZ00418	FZ00418
MA00012	MA00012	MA00012	MA00012	MA00012	MA00012	MA00012	MA00012	MA00012	MA00012	MA00012
RE00011	RE00011				RE00011		RE00011	RE00011	RE00011	
RL00022	RL00022	RL00022	RL00022	RL00022	RL00022	RL00022	RL00022	RL00022	RL00022	RL00022
9923600	9923600	9923600	9923600	9923600	9923600	9923600	9923600	9923600	9923600	9923600

MAXI SCOOTER



Piaggio	Piaggio	Piaggio	Piaggio	Piaggio	Piaggio
Vespa S 4T IE & COLLEGE	X-Evo 125	X-Evo 250	X-Evo 400	X7 125 EU3	X7 250 EU3
09-11	07-16	07-16	07-11	08-08	08-08
150cc 4T AC	125cc 4T LC	250cc 4T LC	400cc 4T LC	125cc 4T LC	250cc 4T LC
			Piaggio M521M	Leader	Piaggio M622M

ALBERO A CAMME								
ALBERO MOTORE		Sel. 1	IM070701	IM070701		IM070701		
		Sel. 2	IM070702	IM070702		IM070702		
BIELLA								
CAMPANA FRIZIONE			FZ00395	FZ00395	FZ00384	FZ00395		
CINGHIA DI TRASMISSIONE		Bando						
		Mitsuboshi	9927650	9927650		9927630	9927650	
		Altro						
COLLETTORE ASPIRAZIONE								
FILTRO OLIO			FO07515	FO07515	FO07515	FO07515		
FRIZIONE				FZ00396	FZ00382	FZ00396		
GRUPPO TERMICO		Standard						
		Maggiorato						
KIT CUSCINETTI/PARAOLI DI BANCO		Serie						
KIT REVISIONE POMPA ACQUA				AA00826	AA00828	AA00824	AA00826	AA00828
MASSE CENTRIFUGHE PESO ORIGINALE					9924530			
MEMBRANA CARBURATORE		Tipo originale						
		Adattabile						
MOLLA CONTRASTO VARIATORE					9926780			
MOTORINO D'AVVIAMENTO			MA00012	MA00012	MA00016		MA00012	MA00016
REGOLATORE DI TENSIONE				RE00011	RE00004	RE00004	RE00011	RE00004
RUOTA LIBERA		Complete						
		RL + flangia			RL00041	RL00021		RL00041
		RL nuda						
		Ingranaggio	RL00022	RL00022	RL00023	RL00023	RL00022	RL00023
		Flangia						
SERIE DISCHI FRIZIONE								
STATORE				ST00023	ST00005			ST00023
VARIATORE VARIOTOP TPR			9923600	9923600	9923650	9924760	9923600	9923650

MAXI SCOOTER

Piaggio	Piaggio	Piaggio	Piaggio	Piaggio	Piaggio	Piaggio	Piaggio	Piaggio	Piaggio	Piaggio
X7 Evo 125 IE EU3	X7 Evo 300 IE EU3	X8 125	X8 125	X8 125 Premium EU2	X8 125 Premium EU3	X8 200	X8 200	X8 250 EU3	X8 400 EU3	X8 Street 125 EU2
09-10	09-10	04-04	05-06	06-06	06-07	04-04	05-07	05-08	06-08	06-07
125cc 4T LC	300cc 4T LC	125cc 4T LC	125cc 4T LC	125cc 4T LC	125cc 4T LC	200cc 4T LC	200cc 4T LC	250cc 4T LC	400cc 4T LC	125cc 4T AC
	Piaggio M624M	Leader						Quasar	Piaggio M521M	
		IM070701	IM070701	IM070701	IM070701					IM070701
		IM070702	IM070702	IM070702	IM070702					IM070702
FZ00395	FZ00395	FZ00395	FZ00395			FZ00395	FZ00395		FZ00384	
9927650		9927650	9927650	9927650	9927650				9927630	9927650
		CT00735	CT00735	CT00735		CT00735	CT00735			CT00736
FO07515	FO07515	FO07515	FO07515	FO07515	FO07515	FO07515	FO07515	FO07515		FO07515
FZ00396		FZ00396	FZ00396			FZ00378		FZ00382		FZ00418
	AA00828	AA00817	AA00826	AA00826	AA00826	AA00817	AA00826	AA00828		
	9931880					9932790	9932790		9924530	
									9926780	
MA00016	MA00016	MA00012	MA00012	MA00012	MA00012		MA00012	MA00016		MA00012
		RE00011	RE00011	RE00011	RE00011		RE00011	RE00004	RE00004	RE00011
RL00041	RL00021							RL00041	RL00021	
RL00023	RL00023	RL00022	RL00022	RL00022	RL00022	RL00022	RL00022	RL00023	RL00023	RL00022
								ST00023	ST00005	
9923600	9923650	9923600	9923600	9923600	9923600	9923650	9923650	9923650	9924760	

MAXI SCOOTER



Piaggio	Piaggio	Piaggio	Piaggio	Piaggio	Piaggio
X8 Street 150 EU2	X9 125	X9 200	X9 250	X9 500	X9 Amalfi 180
06-08	01-02	02-03	00-01	01-02	00-03
150cc 4T AC	125cc 4T LC	200cc 4T LC	250cc 4T LC	500cc 4T LC	180cc 4T LC
			Motore Honda		

ALBERO A CAMME						
ALBERO MOTORE		Sel. 1	IM070701	IM070701		
		Sel. 2	IM070702	IM070702		
BIELLA						
CAMPANA FRIZIONE			FZ00395	FZ00377		FZ00384 FZ00377
CINGHIA DI TRASMISSIONE		Bando			9917990	
		Mitsuboshi	9927650	9927650	9935720	9935460
		Altro				
COLLETTORE ASPIRAZIONE			CT00736	CT00734	CT00734	CT00734
FILTRO OLIO			FO07515	FO07515	FO07515	FO07515
FRIZIONE			FZ00418	FZ00396	FZ00390	FZ00383 FZ00378
GRUPPO TERMICO		Standard				
		Maggiorato				
KIT CUSCINETTI/PARAOLI DI BANCO		Serie				
KIT REVISIONE POMPA ACQUA				AA00817	AA00817	AA00817
MASSE CENTRIFUGHE PESO ORIGINALE				9932790		9922330 9932790
MEMBRANA CARBURATORE		Tipo originale		MC12002		
		Adattabile				
MOLLA CONTRASTO VARIATORE						9926780
MOTORINO D'AVVIAMENTO			MA00012	MA00012	MA00012	MA00012
REGOLATORE DI TENSIONE			RE00011	RE00011	RE00011	RE00004 RE00011
RUOTA LIBERA		Complete				
		RL + flangia				RL00021
		RL nuda				
		Ingranaggio	RL00022	RL00022	RL00022	RL00023
		Flangia				
SERIE DISCHI FRIZIONE						
STATORE						
VARIATORE VARIOTOP TPR			9923600	9923600	9923650	9923750 9923250

MAXI SCOOTER

Piaggio	Piaggio	Piaggio	Piaggio	Piaggio	Piaggio	Piaggio	Piaggio	Piaggio	Piaggio	Piaggio
X9 Evolution 125	X9 Evolution 125	X9 Evolution 200	X9 Evolution 250	X9 Evolution 250	X9 Evolution 500	X9 Evolution 500	X9 Evolution ABS 500	X9 Evolution EU3 125	Zip 100	Zip 125
03-03	05-06	03-03	04-04	06-06	03-05	06-07	06-07	07-07	06-10	00-02
125cc 4T LC	125cc 4T LC	200cc 4T LC	250cc 4T LC	250cc 4T LC	500cc 4T LC	500cc 4T LC	500cc 4T LC	125cc 4T LC	100cc 4T AC	125cc 4T AC
			Piaggio M237M		Piaggio	Piaggio	Piaggio			Leader
IM070701	IM070701							IM070701		IM070701
IM070702	IM070702							IM070702		IM070702
					FZ00384	FZ00384				FZ00377
9927650	9927650		9935470	9935470	9927630	9927630	9927630	9927650		9927650
CT00734	CT00735	CT00734	CT00735	CT00735						CT00740
FO07515	FO07515	FO07515	FO07515	FO07515				FO07515	9922040	FO07515
					FZ00383	FZ00383				FZ00396
AA00817	AA00826	AA00817		AA00828				AA00826		
		9932790			9922330					
										MC12002
					9926780	9926780	9926780			
MA00012	MA00012	MA00012	MA00016	MA00016				MA00012		MA00012
RE00011	RE00011	RE00011	RE00011	RE00011	RE00004	RE00004	RE00004	RE00011	RE00018	RE00011
			RL00021	RL00021	RL00021	RL00021				
RL00022	RL00022	RL00022	RL00023	RL00023	RL00023	RL00023	RL00023	RL00022		RL00022
					ST00005	ST00005	ST00005		ST00004	
9923600	9923600		9923650	9923650	9923250	9923250	9923250	9923600		9923600

MAXI SCOOTER



Renault	Suzuki	Suzuki	Suzuki	Suzuki	Suzuki
Fulltime 125	AN Burgman 250 K3/K6	AN Burgman 250 W/K2	AN Burgman 400 K3/K6	AN Burgman 400 K7/L0	AN Burgman 400 L1
-00	03-06	98-02	03-06	07-10	11-11
125cc 4T AC	250cc 4T LC	250cc 4T LC	400cc 4T LC	400cc 4T LC	400cc 4T LC
Leader					

ALBERO A CAMME						
ALBERO MOTORE		Sel. 1 Sel. 2	IM07050		IM07051	
BIELLA						
CAMPANA FRIZIONE			FZ00377			FZ00402 FZ00402
CINGHIA DI TRASMISSIONE		Bando Mitsuboshi Altro		9915790	9915790 9920430	9920430 9927660 9927660
COLLETTORE ASPIRAZIONE						
FILTRO OLIO			FO07515	FO07510	FO07510	FO07510 FO07522 FO07522
FRIZIONE			FZ00378		FZ00403	FZ00419 FZ00419
GRUPPO TERMICO		Standard Maggiorato				
KIT CUSCINETTI/PARAOLI DI BANCO		Serie		KK01006	KK01006	KK01006
KIT REVISIONE POMPA ACQUA			AA00817	AA00819	AA00819	AA00819
MASSE CENTRIFUGHE PESO ORIGINALE					9918410	9922390
MEMBRANA CARBURATORE		Tipo originale Adattabile				
MOLLA CONTRASTO VARIATORE					9926790	9926790
MOTORINO D'AVVIAMENTO			MA00021	MA00021	MA00021	
REGOLATORE DI TENSIONE						
RUOTA LIBERA		Complete RL + flangia RL nuda Ingranaggio Flangia		RL00018	RL00018	RL00012
SERIE DISCHI FRIZIONE						
STATORE						
VARIATORE VARIOTOP TPR			9923600	9923790	9923790	9922430 9926010

MAXI SCOOTER



Suzuki	Suzuki	Suzuki	Suzuki	Suzuki	Suzuki
UE CT 125 K1	UE CT 150 K1	UH Burgman 125 K2/K6	UH Burgman 125 K7/L0	UH Burgman 125 L1	UH Burgman 125 L3
01-01	01-01	02-06	07-10	11-11	13-13
125cc 4T AC	150cc 4T AC	125cc 4T LC	125cc 4T LC	125cc 4T LC	125cc 4T LC

ALBERO A CAMME						
ALBERO MOTORE		Sel. 1 Sel. 2				
BIELLA						
CAMPANA FRIZIONE					FZ00412	FZ00412
CINGHIA DI TRASMISSIONE		Bando Mitsuboshi Altro		9927500	9927510	9927510
COLLETORE ASPIRAZIONE						
FILTRO OLIO			FO07522	FO07522	FO07522	FO07522
FRIZIONE					FZ00413	FZ00413
GRUPPO TERMICO		Standard Maggiorato				
KIT CUSCINETTI/PARAOLI DI BANCO		Serie		KK01006	KK01006	
KIT REVISIONE POMPA ACQUA				AA00819	AA00819	AA00819
MASSE CENTRIFUGHE PESO ORIGINALE				9916690	9916690	9916690
MEMBRANA CARBURATORE		Tipo originale Adattabile				
MOLLA CONTRASTO VARIATORE						
MOTORINO D'AVVIAMENTO				MA00021		
REGOLATORE DI TENSIONE						
RUOTA LIBERA		Complete RL + flangia RL nuda Ingranaggio Flangia		RL00017		
SERIE DISCHI FRIZIONE						
STATORE						
VARIATORE VARIOTOP TPR				9923460	9923460	

MAXI SCOOTER

Suzuki	Suzuki	Suzuki	Suzuki	Suzuki	Suzuki	Suzuki	Sym	Sym	Sym	Sym
UH Burgman 150 K2/K6	UH Burgman 200 K7/L0	UH Burgman 200 L1	UX Sixteen 125 K8/L0	UX Sixteen 125 L1	UX Sixteen 150 K8/L0	UX Sixteen 150 L1	Attila 125	Attila 150	Citycon 300	Euro MX 125
02-06	07-10	11-12	08-10	11-11	08-10	11-11	99-00	99-00	08-09	02-02
150cc 4T LC	200cc 4T LC	200cc 4T LC	125cc 4T LC	125cc 4T LC	150cc 4T LC	150cc 4T LC	125cc 4T AC	150cc 4T AC	300cc 4T-4V LC	125cc 4T AC
IM07052										
			FZ00412	FZ00412	FZ00412	FZ00412	FZ00416	FZ00416		FZ00416
9927500	9927520	9927520	9935530	9935530	9935540	9935540			9935550	
FO07522	FO07522	FO07522	FO07522	FO07522	FO07522	FO07522				
	FZ00414	FZ00414	FZ00413	FZ00413					FZ00388	
KK01006	KK01006		KK01006		KK01006					
AA00819	AA00819	AA00819								
MA00021										MA00026
RL00017										
9923460			9923460		9923460					

MAXI SCOOTER



Sym	Sym	Sym	Sym	Sym	Sym
Euro MX 150	Euro MX EU2 125	Euro MX EU2 150	Fiddle II 125	Fiddle II 125	Fiddle II 125
02-02	03-04	03-04	08-08	09-09	10-10
150cc 4T AC	125cc 4T AC	150cc 4T AC	125cc 4T AC	125cc 4T AC	125cc 4T AC

ALBERO A CAMME						
ALBERO MOTORE		Sel. 1				IM07069
		Sel. 2				
BIELLA						
CAMPANA FRIZIONE		FZ00416	FZ00416	FZ00416	FZ00416	FZ00416
CINGHIA DI TRASMISSIONE		Bando			9926420	9926420
		Mitsuboshi				
		Altro				
COLLETORE ASPIRAZIONE						
FILTRO OLIO						
FRIZIONE						FZ00417
GRUPPO TERMICO		Standard				
		Maggiorato				
KIT CUSCINETTI/PARAOLI DI BANCO		Serie				
KIT REVISIONE POMPA ACQUA						
MASSE CENTRIFUGHE PESO ORIGINALE						
MEMBRANA CARBURATORE		Tipo originale				
		Adattabile				
MOLLA CONTRASTO VARIATORE						
MOTORINO D'AVVIAMENTO		MA00026	MA00026	MA00026	MA00007	MA00007
REGOLATORE DI TENSIONE						
RUOTA LIBERA		Complete				
		RL + flangia				
		RL nuda				
		Ingranaggio				
		Flangia				
SERIE DISCHI FRIZIONE						
STATORE						
VARIATORE VARIOTOP TPR						

MAXI SCOOTER



Sym	Sym	Sym	Sym	Sym	Sym
HD EVO EU3 I 200	HD EVO I EU3	HD EVO I Tamburo EU3 200	HD EVO Tamburo EU3 125	HD2 125	HD2 I 200
07-07	10-10	08-09	08-09	11-11	11-11
200cc 4T-4V LC	200cc 4T-4V LC	200cc 4T-4V LC	125cc 4T-4V LC	125cc 4T-4V LC	200cc 4T-4V LC

ALBERO A CAMME						
ALBERO MOTORE		Sel. 1 Sel. 2				
BIELLA						
CAMPANA FRIZIONE					FZ00416	FZ00416
CINGHIA DI TRASMISSIONE		Bando Mitsuboshi Altro	9925860	9925860	9925860	9925860
COLLETORE ASPIRAZIONE						
FILTRO OLIO						
FRIZIONE						
GRUPPO TERMICO		Standard Maggiorato				
KIT CUSCINETTI/PARAOLI DI BANCO		Serie				
KIT REVISIONE POMPA ACQUA						
MASSE CENTRIFUGHE PESO ORIGINALE						
MEMBRANA CARBURATORE		Tipo originale Adattabile				
MOLLA CONTRASTO VARIATORE						
MOTORINO D'AVVIAMENTO					MA00004	MA00004
REGOLATORE DI TENSIONE						
RUOTA LIBERA		Complete RL + flangia RL nuda Ingranaggio Flangia				
SERIE DISCHI FRIZIONE						
STATORE						
VARIATORE VARIOTOP TPR						

MAXI SCOOTER



Sym	Sym	Sym	Sym	Sym	Sym
JoyRide EVO	Megalo 125	New Duke 125	Shark 125	Shark 150	Super Duke 125
10-10	06-07	00-01	99-02	00-01	99-02
125cc 4T-4V LC	125cc 4T AC	125cc 4T AC	125cc 4T AC	150cc 4T AC	125cc 4T AC

ALBERO A CAMME						
ALBERO MOTORE		Sel. 1 Sel. 2				
BIELLA						
CAMPANA FRIZIONE			FZ00416	FZ00416	FZ00416	FZ00416
CINGHIA DI TRASMISSIONE		Bando Mitsuboshi Altro				
COLLETORE ASPIRAZIONE						
FILTRO OLIO						
FRIZIONE						
GRUPPO TERMICO		Standard Maggiorato				
KIT CUSCINETTI/PARAOLI DI BANCO		Serie				
KIT REVISIONE POMPA ACQUA						
MASSE CENTRIFUGHE PESO ORIGINALE						
MEMBRANA CARBURATORE		Tipo originale Adattabile				
MOLLA CONTRASTO VARIATORE						
MOTORINO D'AVVIAMENTO			MA00004		MA00026	MA00026
REGOLATORE DI TENSIONE						RE00013
RUOTA LIBERA		Complete RL + flangia RL nuda Ingranaggio Flangia				
SERIE DISCHI FRIZIONE						
STATORE						
VARIATORE VARIOTOP TPR						

MAXI SCOOTER



Sym	Sym	Sym	Sym	Sym	Sym
Symphony SR 125	Symphony SR 150	Symphony SR 150	Symply 125	Symply II 125	VS 125
12-12	10-10	12-12	07-08	09-10	06-06
125cc 4T AC	150cc 4T AC	150cc 4T AC	125cc 4T AC	125cc 4T AC	125cc 4T-4V AC

ALBERO A CAMME						
ALBERO MOTORE		Sel. 1 Sel. 2				
BIELLA						
CAMPANA FRIZIONE			FZ00416		FZ00416	FZ00416
CINGHIA DI TRASMISSIONE		Bando Mitsuboshi Altro	9931680	9931680	9931680	9926420
COLLETORE ASPIRAZIONE						
FILTRO OLIO						
FRIZIONE				FZ00417		
GRUPPO TERMICO		Standard Maggiorato				
KIT CUSCINETTI/PARAOLI DI BANCO		Serie				
KIT REVISIONE POMPA ACQUA						
MASSE CENTRIFUGHE PESO ORIGINALE						
MEMBRANA CARBURATORE		Tipo originale Adattabile	MC12005		MC12005	
MOLLA CONTRASTO VARIATORE						
MOTORINO D'AVVIAMENTO				MA00026	MA00007	
REGOLATORE DI TENSIONE						RE00023
RUOTA LIBERA		Complete RL + flangia RL nuda Ingranaggio Flangia				
SERIE DISCHI FRIZIONE						
STATORE						
VARIATORE VARIOTOP TPR						

MAXI SCOOTER



Yamaha	Yamaha	Yamaha	Yamaha	Yamaha	Yamaha
Cygnus X 125 (NXC)	Cygnus X 125 ie EU3 (NXC)	Cygnus125 (XCT)	Majesty 125	Majesty 125 (5NR1)	Majesty 125 (5NR8)
04-06	07-11	95-98	98-00	01-01	02-02
125cc 4T AC	125cc 4T AC	125cc 4T AC	125cc 4T LC	125cc 4T LC	125cc 4T LC
			Minarelli YP	Minarelli YP	Minarelli YP

ALBERO A CAMME						
ALBERO MOTORE		Sel. 1			IM07045	IM07045
		Sel. 2				
BIELLA						
CAMPANA FRIZIONE						
CINGHIA DI TRASMISSIONE		Bando	9931560	9931560	9931550	9915380
		Mitsuboshi	9935750	9935750		9915380
		Altro				9915380
COLLETTORE ASPIRAZIONE					CT00730	CT00730
FILTRO OLIO						
FRIZIONE			FZ00371	FZ00371	FZ00371	FZ00371
GRUPPO TERMICO		Standard				
		Maggiorato			9929380	9929380
KIT CUSCINETTI/PARAOLI DI BANCO		Serie			KK01010	KK01010
KIT REVISIONE POMPA ACQUA					AA00805	AA00805
MASSE CENTRIFUGHE PESO ORIGINALE			9915270	9915270	9916220	9915270
MEMBRANA CARBURATORE		Tipo originale			MC12000	MC12000
		Adattabile			MC12100	MC12100
MOLLA CONTRASTO VARIATORE					9929170	9929170
MOTORINO D'AVVIAMENTO			MA00017	MA00017	MA00017	MA00017
REGOLATORE DI TENSIONE					RE00020	RE00020
RUOTA LIBERA		Complete				
		RL + flangia			RL00002	RL00002
		RL nuda				
		Ingranaggio				
		Flangia				
SERIE DISCHI FRIZIONE						
STATORE					ST00002	ST00002
VARIATORE VARIOTOP TPR					9923550	9923550

MAXI SCOOTER

Yamaha	Yamaha	Yamaha	Yamaha	Yamaha	Yamaha	Yamaha	Yamaha	Yamaha	Yamaha	Yamaha
Majesty 125 E	Majesty 125 E	Majesty 125 E	Majesty 125 E	Majesty 125 E	Majesty 150	Majesty 150 (SNS1)	Majesty 150 (SNS6)	Majesty 180 E	Majesty 250	Majesty 250
03-05	06-06	07-07	08-08	09-09	00-00	01-01	02-02	03-06	96-98	00-01
125cc 4T LC	125cc 4T LC	125cc 4T LC	125cc 4T LC	125cc 4T LC	150cc 4T LC	150cc 4T LC	150cc 4T LC	180cc 4T LC	250cc 4T LC	250cc 4T LC
Minarelli YP	Minarelli YP	Minarelli YP	Minarelli YP	Minarelli YP	Minarelli YP	Minarelli YP	Minarelli YP	Minarelli YP	Yamaha YP	Yamaha YP
IM07045	IM07045	IM07045	IM07045	IM07045					IM07054	IM07054
									IM07037	IM07037
										FZ00397
9915380	9915380	9915380	9915380	9915380	9915380	9915380	9915380	9915380	9915800	9915800
9935700	9935700	9935700	9935700	9935700	9935700	9935700	9935700	9935700	9935710	9935710
CT00729	CT00729	CT00729	CT00729	CT00729	CT00730	CT00730	CT00730	CT00729		
FZ00371	FZ00371	FZ00371	FZ00371	FZ00371	FZ00401	FZ00401	FZ00401	FZ00401	FZ00401	FZ00388
									9926850	9926850
9929380	9929380	9929380	9929380	9929380	9929380	9929380	9929380			
KK01010	KK01010	KK01010	KK01010	KK01010	KK01010	KK01010	KK01010	KK01010	KK01007	KK01007
AA00805	AA00805	AA00805	AA00805	AA00805	AA00805	AA00805	AA00805	AA00805	AA00806	AA00806
									9918020	9918020
MC12001	MC12001	MC12001	MC12001	MC12001	MC12000	MC12000	MC12000	MC12001	MC12001	MC12001
MC12101	MC12101	MC12101	MC12101	MC12101	MC12100	MC12100	MC12100	MC12101	MC12101	MC12101
9929170	9929170	9929170	9929170	9929170	9929170	9929170	9929170		9929870	9929870
MA00017	MA00017	MA00017	MA00017	MA00017	MA00017	MA00017	MA00017	MA00017	MA00010	MA00010
RE00030	RE00030	RE00030	RE00030	RE00030	RE00020	RE00020	RE00030	RE00030		
RL00032	RL00032	RL00032	RL00032	RL00032	RL00002	RL00002	RL00002	RL00032	RL00010	RL00010
									RL00011	RL00011
ST00002	ST00002	ST00002	ST00002	ST00002	ST00002	ST00002	ST00002	ST00002		
9923550	9923550	9923550	9923550	9923550	9923550	9923550	9923550	9923550	9931790	9931790

MAXI SCOOTER



Yamaha	Yamaha	Yamaha	Yamaha	Yamaha	Yamaha
Majesty 250	Majesty 250 ABS	Majesty 250 DX	Majesty 250 DX	Majesty 400	Majesty 400
02-03	03-03	98-98	99-99	04-05	06-06
250cc 4T LC	250cc 4T LC	250cc 4T LC	250cc 4T LC	400cc 4T LC	400cc 4T LC
Yamaha YP	Yamaha YP	Yamaha YP	Yamaha YP	5RU	5RU

ALBERO A CAMME								
ALBERO MOTORE		Sel. 1	IM07054	IM07054	IM07054	IM07054		
		Sel. 2						
BIELLA			IM07037	IM07037	IM07037	IM07037		
CAMPANA FRIZIONE			FZ00397	FZ00397				
CINGHIA DI TRASMISSIONE		Bando	9915800	9915800	9915800	9915800		
		Mitsuboshi	9935710	9935710	9935710	9935710	9927530	9927530
		Altro						
COLLETTORE ASPIRAZIONE								
FILTRO OLIO						FO07521	FO07521	
FRIZIONE			FZ00388	FZ00388	FZ00401	FZ00401	FZ00394	FZ00394
GRUPPO TERMICO		Standard	9926850	9926850	9926850	9926850		
		Maggiorato						
KIT CUSCINETTI/PARAOLI DI BANCO		Serie	KK01007	KK01007	KK01007	KK01007		
KIT REVISIONE POMPA ACQUA			AA00806	AA00806	AA00806	AA00806	AA00818	AA00818
MASSE CENTRIFUGHE PESO ORIGINALE			9918020	9918020	9918020	9918020	9922150	9922150
MEMBRANA CARBURATORE		Tipo originale	MC12001	MC12001	MC12001	MC12001		
		Adattabile	MC12101	MC12101	MC12101	MC12101		
MOLLA CONTRASTO VARIATORE			9929870	9929870	9929870	9929870		
MOTORINO D'AVVIAMENTO			MA00010	MA00010	MA00010	MA00010	MA00010	MA00010
REGOLATORE DI TENSIONE			RE00022	RE00022			RE00022	RE00022
RUOTA LIBERA		Complete						
		RL + flangia	RL00010	RL00010	RL00010	RL00010	RL00019	RL00019
		RL nuda						
		Ingranaggio	RL00011	RL00011	RL00011	RL00011	RL00020	RL00020
		Flangia						
SERIE DISCHI FRIZIONE								
STATORE								
VARIATORE VARIOTOP TPR			9931790	9931790	9931790	9931790	9923330	9923330

MAXI SCOOTER

Yamaha	Yamaha	Yamaha	Yamaha	Yamaha	Yamaha	Yamaha	Yamaha	Yamaha	Yamaha	Yamaha
Majesty 400	Majesty 400	Majesty 400 ABS	Majesty 400 ABS	Majesty 400 ABS	Maxter 125	Maxter 150	Neo's 100	T-Max 4B5 500	T-Max 4B5 ABS 500	T-Max 59C 530
07-08	09-11	07-07	08-08	09-11	01-02	01-02	99-02	09-11	08-11	12-12
400cc 4T LC	400cc 4T LC	400cc 4T LC	400cc 4T LC	400cc 4T LC	125cc 4T LC	150cc 4T LC	100cc 2T AC	500cc 4T LC	500cc 4T LC	530cc 4T LC
5RU	34B	5RU	5RU	34B	Minarelli YP	Minarelli YP		4B5	4B5	59C
					IM07045					
					9915380	9915380				
9935580	9935610	9935580	9935580	9935610	9935700	9935700	9935200	9927550	9927550	
					CT00730	CT00730				
FO07521	FO07521	FO07521	FO07521	FO07521				FO07517	FO07517	FO07517
FZ00394	FZ00394	FZ00394	FZ00394	FZ00394	FZ00371	FZ00401				
					9929380	9929380				
					KK01010	KK01010				
AA00818		AA00818	AA00818		AA00805	AA00805		AA00820	AA00820	AA00831
9922150	9922230	9922150	9922150	9922230	9915270			9922230	9922230	9922210
					MC12000	MC12000				
					MC12100	MC12100				
					9929170	9929170	9914470	9929880	9929880	9929880
MA00010	MA00010	MA00010	MA00010	MA00010	MA00017	MA00017				
RE00022	RE00022	RE00022	RE00022	RE00022				RE00022	RE00022	
RL00019	RL00019	RL00019	RL00019	RL00019	RL00002	RL00002		RL00015	RL00015	RL00015
RL00020	RL00020	RL00020	RL00020	RL00020				RL00016	RL00016	RL00016
								9928150	9928150	9930880
					ST00002	ST00002		ST00021	ST00021	ST00020
9923330	9930360	9923330	9923330	9930360	9923550	9923550		9927130	9927130	9927130

MAXI SCOOTER



Yamaha	Yamaha	Yamaha	Yamaha	Yamaha	Yamaha
T-Max 59C 530	T-Max 59C 530	T-Max 59C 530 ABS	T-Max 59C 530 ABS	T-Max 59C 530 ABS	T-Max 59C 530 SP
13-14	15-16	12-12	13-14	15-16	15-15
530cc 4T LC	530cc 4T LC	530cc 4T LC	530cc 4T LC	530cc 4T LC	530cc 4T LC
59C	59C	59C	59C	59C	59C

ALBERO A CAMME						
ALBERO MOTORE		Sel. 1				
		Sel. 2				
BIELLA						
CAMPANA FRIZIONE						
CINGHIA DI TRASMISSIONE		Bando				
		Mitsuboshi				
		Altro				
COLLETTORE ASPIRAZIONE						
FILTRO OLIO			FO07517	FO07517	FO07517	FO07517
FRIZIONE						
GRUPPO TERMICO		Standard				
		Maggiorato				
KIT CUSCINETTI/PARAOLI DI BANCO		Serie				
KIT REVISIONE POMPA ACQUA			AA00831	AA00831	AA00831	AA00831
MASSE CENTRIFUGHE PESO ORIGINALE			9922210	9922210	9922210	9922210
MEMBRANA CARBURATORE		Tipo originale				
		Adattabile				
MOLLA CONTRASTO VARIATORE			9929880	9929880	9929880	9929880
MOTORINO D'AVVIAMENTO						
REGOLATORE DI TENSIONE						
RUOTA LIBERA		Complete				
		RL + flangia	RL00015	RL00015	RL00015	RL00015
		RL nuda				
		Ingranaggio	RL00016	RL00016	RL00016	RL00016
		Flangia				
SERIE DISCHI FRIZIONE			9930880	9930880	9930880	9930880
STATORE			ST00020	ST00020	ST00020	ST00020
VARIATORE VARIOTOP TPR			9927130	9927130	9927130	9927130

MAXI SCOOTER



Yamaha	Yamaha	Yamaha	Yamaha	Yamaha	Yamaha
T-Max SV	T-Max SV ABS	T-Max White Max	Teo's 125	Teo's 150	Versity 300
11-11	11-11	10-10	00-00	01-02	03-03
500cc 4T LC	500cc 4T LC	500cc 4T LC	125cc 4T LC	150cc 4T LC	300cc 4T LC
4B5	4B5	4B5	Minarelli YP	Minarelli YP	Minarelli YP

ALBERO A CAMME								
ALBERO MOTORE		Sel. 1			IM07045			
		Sel. 2						
BIELLA						IM07037		
CAMPANA FRIZIONE						FZ00397		
CINGHIA DI TRASMISSIONE		Bando			9915380	9915380		
		Mitsuboshi	9927550	9927550	9927550	9935700	9935700	9925600
		Altro						
COLLETTORE ASPIRAZIONE					CT00730	CT00730		
FILTRO OLIO								
FRIZIONE					FZ00371	FZ00401	FZ00388	
GRUPPO TERMICO		Standard						
		Maggiorato			9929380	9929380		
KIT CUSCINETTI/PARAOLI DI BANCO		Serie			KK01010	KK01010	KK01007	
KIT REVISIONE POMPA ACQUA					AA00805	AA00805	AA00806	
MASSE CENTRIFUGHE PESO ORIGINALE					9915270		9918020	
MEMBRANA CARBURATORE		Tipo originale			MC12000	MC12000	MC12001	
		Adattabile			MC12100	MC12100	MC12101	
MOLLA CONTRASTO VARIATORE					9929170	9929170		
MOTORINO D'AVVIAMENTO					MA00017	MA00017	MA00010	
REGOLATORE DI TENSIONE			RE00022	RE00022	RE00022		RE00020	RE00022
RUOTA LIBERA		Complete						
		RL + flangia			RL00002	RL00002	RL00010	
		RL nuda						
		Ingranaggio					RL00011	
		Flangia						
SERIE DISCHI FRIZIONE								
STATORE			ST00021	ST00021	ST00021	ST00002	ST00002	
VARIATORE VARIOTOP TPR					9923550	9923550		

MAXI SCOOTER

Yamaha	Yamaha	Yamaha	Yamaha	Yamaha	Yamaha	Yamaha	Yamaha	Yamaha	Yamaha	Yamaha
Versity 300	Versity 300	Vity 125	Vity 125	X-City 125 EU3	X-City 250	X-City 250	X-City 250	X-City 250	X-MAX	X-MAX
04-05	06-06	08-10	11-11	08-11	07-07	08-08	09-12	13-13	15-16	15-16
300cc 4T LC	300cc 4T LC	125cc 4T AC	125cc 4T AC	125cc 4T-4V LC	250cc 4T LC	250cc 4T LC	250cc 4T LC	250cc 4T LC	400cc 4T-4V LC	400cc 4T-4V LC
Minarelli YP	Minarelli YP			Minarelli					1SD	1SD
				9927230						
				IM07072	IM07054	IM07054	IM07054			
IM07037	IM07037				IM07037	IM07037	IM07037			
FZ00397	FZ00397			FZ00415	FZ00397	FZ00397	FZ00397			
9925600	9925600	9935640	9935620	9925280	9925600	9925600	9925600		9935650	9935650
				FO07523					FO07521	FO07521
FZ00388	FZ00388			FZ00401	FZ00388	FZ00388	FZ00388		FZ00394	FZ00394
				9932700	9926850	9926850	9926850			
				9925180						
KK01007	KK01007				KK01007	KK01007	KK01007			
AA00806	AA00806			AA00823	AA00806	AA00806	AA00806		AA00818	AA00818
9918020	9918020				9918060	9918060	9918060		9922230	9922230
MC12001	MC12001									
MC12101	MC12101									
				9926760	9929870	9929870	9929870			
MA00010	MA00010			MA00028	MA00010	MA00010	MA00010		MA00010	MA00010
RE00022	RE00022			RE00023	RE00023	RE00023	RE00023	RE00023		
RL00010	RL00010			RL00034	RL00010	RL00010	RL00010		RL00019	RL00019
RL00011	RL00011			RL00035	RL00011	RL00011	RL00011		RL00020	RL00020
				9925020	9931790	9931790	9931790	9931790	9930360	9930360

MAXI SCOOTER



Yamaha	Yamaha	Yamaha	Yamaha	Yamaha	Yamaha
X-MAX ABS	X-MAX ABS	X-MAX IRONMAX ABS	X-MAX MOMODESIGN	X-MAX MOMODESIGN ABS	X-Max 250
14-14	15-16	16-16	14-14	14-14	05-06
400cc 4T-4V LC	400cc 4T-4V LC	400cc 4T-4V LC	400cc 4T-4V LC	400cc 4T-4V LC	250cc 4T LC
1SD	1SD	1SD	1SD	1SD	

ALBERO A CAMME						
ALBERO MOTORE		Sel. 1				IM07054
		Sel. 2				
BIELLA						IM07037
CAMPANA FRIZIONE						FZ00397
CINGHIA DI TRASMISSIONE		Bando				
		Mitsuboshi	9935650	9935650	9935650	9935650
		Altro				9925600
COLLETTORE ASPIRAZIONE						
FILTRO OLIO			FO07521	FO07521	FO07521	FO07521
FRIZIONE			FZ00394	FZ00394	FZ00394	FZ00394
GRUPPO TERMICO		Standard				9926850
		Maggiorato				
KIT CUSCINETTI/PARAOLI DI BANCO		Serie				KK01007
KIT REVISIONE POMPA ACQUA			AA00818	AA00818	AA00818	AA00818
MASSE CENTRIFUGHE PESO ORIGINALE			9922230	9922230	9922230	9922230
MEMBRANA CARBURATORE		Tipo originale				
		Adattabile				
MOLLA CONTRASTO VARIATORE						9929870
MOTORINO D'AVVIAMENTO			MA00010	MA00010	MA00010	MA00010
REGOLATORE DI TENSIONE						RE00022
RUOTA LIBERA		Complete				
		RL + flangia	RL00019	RL00019	RL00019	RL00019
		RL nuda				
		Ingranaggio	RL00020	RL00020	RL00020	RL00020
		Flangia				RL00011
SERIE DISCHI FRIZIONE						
STATORE						
VARIATORE VARIOTOP TPR			9930360	9930360	9930360	9930360

MAXI SCOOTER

Yamaha	Yamaha	Yamaha	Yamaha	Yamaha	Yamaha	Yamaha	Yamaha	Yamaha	Yamaha	Yamaha
X-Max 250	X-Max 250	X-Max 250	X-Max 250	X-Max 250 ABS	X-Max 250 ABS	X-Max 250 ABS	X-Max 250 Black	X-Max 250 Sport	X-Max R 125	X-Max R 125
07-09	10-12	12-13	14-14	11-12	12-13	14-14	09-09	11-12	06-07	08-09
250cc 4T LC	250cc 4T LC	250cc 4T LC	250cc 4T LC	250cc 4T LC	250cc 4T LC	250cc 4T LC	250cc 4T LC	250cc 4T LC	125cc 4T-4V LC	125cc 4T-4V LC
									Minarelli	Minarelli
									9927230	9927230
IM07054	IM07054								IM07072	IM07072
IM07037	IM07037									
FZ00397	FZ00397								FZ00415	FZ00415
9925600	9925600								9925280	9925280
									FO07523	FO07523
FZ00388	FZ00388								FZ00401	FZ00401
9926850	9926850								9932700	9932700
									9925180	9925180
KK01007	KK01007									
AA00806	AA00806								AA00823	AA00823
9918020	9918060									
9929870	9929870								9926760	9926760
MA00010	MA00010								MA00028	MA00028
RE00023	RE00030	RE00030	RE00023	RE00030	RE00030	RE00023	RE00023	RE00030	RE00023	RE00023
RL00010	RL00010								RL00034	RL00034
RL00011	RL00011								RL00035	RL00035
9931790	9931790	9931790	9931790	9931790	9931790	9931790	9931790	9931790	9925020	9925020

MAXI SCOOTER



		Yamaha	Yamaha	Yamaha	Yamaha	Yamaha	Yamaha
		X-Max R 125	X-Max R 125	X-Max R 125	X-Max R 125	X-Max R 125	X-Max R 125 ABS
		10-12	12-13	14-14	14-14	15-16	11-11
		125cc 4T-4V LC	125cc 4T-4V LC	125cc 4T-4V LC	125cc 4T-4V LC	125cc 4T-4V LC	125cc 4T-4V LC
		Minarelli	Minarelli	Minarelli	Minarelli	Minarelli	Minarelli
ALBERO A CAMME		9927230	9927230	9927230	9927230	9927230	9927230
ALBERO MOTORE		Sel. 1 IM07072	IM07072	IM07072		IM07072	IM07072
		Sel. 2					
BIELLA							
CAMPANA FRIZIONE		FZ00415	FZ00415	FZ00415	FZ00415	FZ00415	FZ00415
CINGHIA DI TRASMISSIONE		Bando Mitsuboshi Altro	9925280	9925280	9925280	9925280	9925280
COLLETTORE ASPIRAZIONE							
FILTRO OLIO		FO07523	FO07523	FO07523	FO07523	FO07523	FO07523
FRIZIONE		FZ00401	FZ00401	FZ00401	FZ00401	FZ00401	FZ00401
GRUPPO TERMICO		Standard Maggiorato	9932700	9932700	9932700	9932700	9932700
			9925180	9925180		9925180	9925180
KIT CUSCINETTI/PARAOLI DI BANCO		Serie					
KIT REVISIONE POMPA ACQUA		AA00823	AA00823	AA00823	AA00823	AA00823	AA00823
MASSE CENTRIFUGHE PESO ORIGINALE							
MEMBRANA CARBURATORE		Tipo originale Adattabile					
MOLLA CONTRASTO VARIATORE		9926760	9926760	9926760	9926760	9926760	9926760
MOTORINO D'AVVIAMENTO		MA00028	MA00028	MA00028	MA00028	MA00028	MA00028
REGOLATORE DI TENSIONE		RE00030	RE00030	RE00023	RE00023	RE00023	RE00030
RUOTA LIBERA		Complete RL + flangia RL nuda Ingranaggio Flangia	RL00034	RL00034	RL00034	RL00034	RL00034
			RL00035	RL00035	RL00035	RL00035	RL00035
SERIE DISCHI FRIZIONE							
STATORE							
VARIATORE VARIOTOP TPR		9925020	9925020	9925020	9925020	9925020	9925020

MAXI SCOOTER

Yamaha	Yamaha	Yamaha	Yamaha	Yamaha
X-Max RA 125 ABS	X-Max RA 125 ABS	X-Max RA 125 ABS	Xenter 125	Xenter 150
13-13	14-15	16-16	12-16	12-16
125cc 4T-4V LC	125cc 4T-4V LC	125cc 4T-4V LC	125cc 4T LC	150cc 4T LC
Minarelli	Minarelli	Minarelli		
9927230	9927230	9927230		
IM07072	IM07072	IM07072		
FZ00415	FZ00415	FZ00415		
9925280	9925280	9925280	9935760	9935760
			9931610	9931610
FO07523	FO07523	FO07523		
FZ00401	FZ00401	FZ00401		
9932700	9932700	9932700		
9925180	9925180	9925180		
AA00823	AA00823	AA00823	AA00832	AA00832
9926760	9926760	9926760		
MA00028	MA00028	MA00028		
RE00030	RE00023	RE00023		
RL00034	RL00034	RL00034	RL00038	RL00038
RL00035	RL00035	RL00035		
9925020	9925020	9925020		

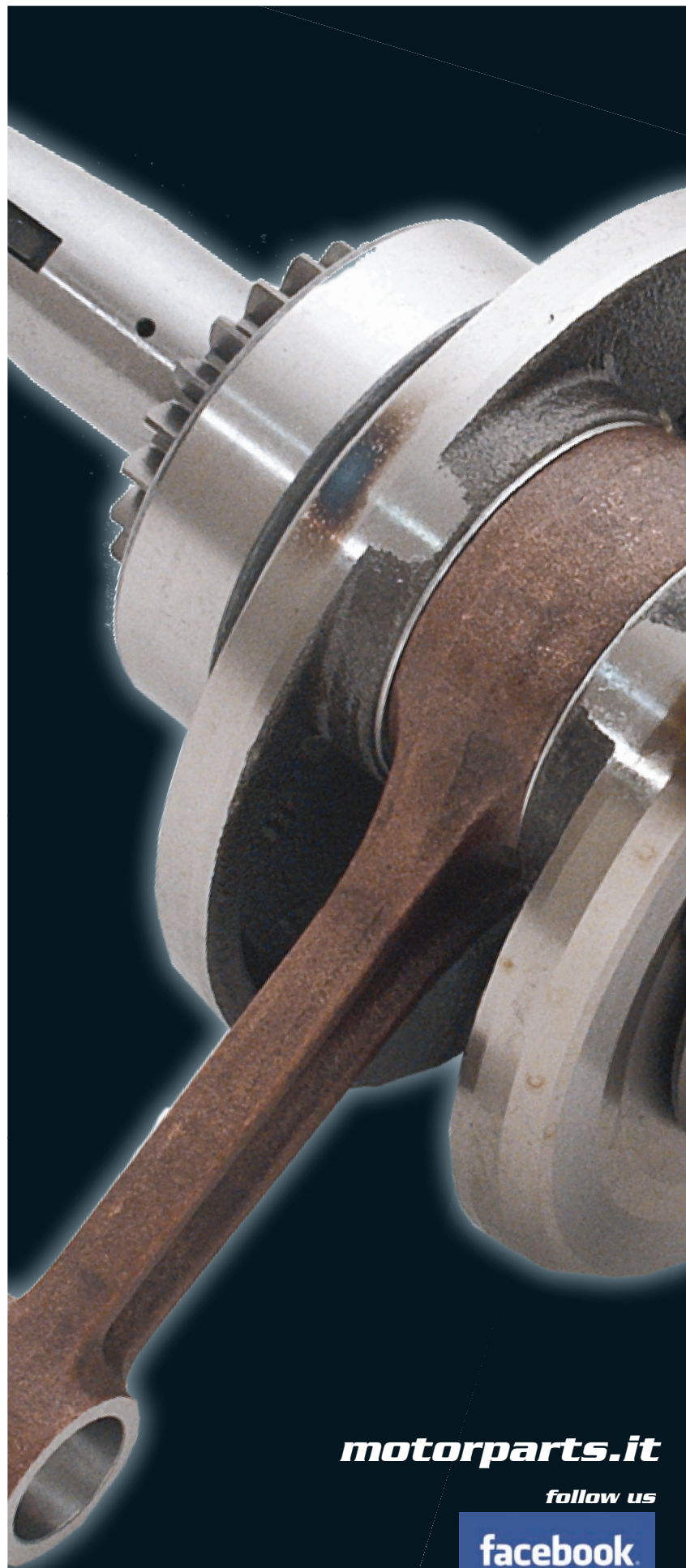







motorparts.it

follow us

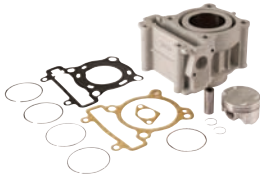
facebook

MOTO 125cc







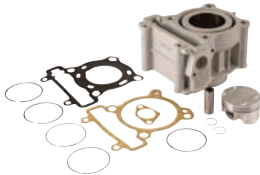

	Beta	Fantic	Fantic	HM	HM	HM
	RR	Caballero Motard	Caballero Regolarità	CITY	CRE F125X	CRE F125X BAJA
	10-10	08-08	08-08	11-13	08-09	10-12
	125cc 4T-4V LC	125cc 4T-4V LC	125cc 4T-4V LC	125cc 4T-4V LC	125cc 4T-4V LC	125cc 4T-4V LC
	Minarelli - Yamaha MC 125	Minarelli - Yamaha MC 125	Minarelli - Yamaha MC 125	Minarelli - Yamaha MC 125	Minarelli - Yamaha MC 125	Minarelli - Yamaha MC 125
ALBERO A CAMME		9927230	9927230	9927230	9927230	9927230
GRUPPO TERMICO ø standard		9932700	9932700	9932700	9932700	9932700
GRUPPOTERMICO ø maggiorato		9927120	9927120	9927120	9927120	9927120
GRUPPO TERMICO ø maggiorato con centralina						
MOLLE FRIZIONE		9927810	9927810	9927810	9927810	9927810
SCARICO						
FILTRO OLIO		FO07523	FO07523	FO07523	FO07523	FO07523

HM	HM	HM	HM	HM	HM	HM	Husqvarna	Husqvarna	Motorhispania	Motorhispania
CRE F125X BAJA RR	CRE F125X SIX	CRM F125X	CRM F125X DERAPAGE	CRM F125X DERAPAGE COMPETITION	CRM F125X DERAPAGE RR	LOCUSTA	SM	TE	KN1	MH7
10-12	10-11	08-09	10-12	10-11	10-12	11-13	10-10	10-10	08-08	08-08
125cc 4T-4V LC	125cc 4T-4V LC	125cc 4T-4V LC	125cc 4T-4V LC	125cc 4T-4V LC	125cc 4T-4V LC	125cc 4T-4V LC	125cc 4T-4V LC	125cc 4T-4V LC	125cc 4T-4V LC	125cc 4T-4V LC
Minarelli - Yamaha MC 125	Minarelli - Yamaha MC 125	Minarelli - Yamaha MC 125	Minarelli - Yamaha MC 125	Minarelli - Yamaha MC 125	Minarelli - Yamaha MC 125	Minarelli - Yamaha MC 125	Minarelli - Yamaha MC 125	Minarelli - Yamaha MC 125	Minarelli - Yamaha MC 125	Minarelli - Yamaha MC 125
9927230	9927230	9927230	9927230	9927230	9927230	9927230	9927230	9927230	9927230	9927230
9932700	9932700	9932700	9932700	9932700	9932700	9932700	9932700	9932700	9932700	9932700
9927120	9927120	9927120	9927120	9927120	9927120	9927120	9927120	9927120	9927120	9927120
9927810	9927810	9927810	9927810	9927810	9927810	9927810	9927810	9927810	9927810	9927810
	FO07523	FO07523	FO07523	FO07523	FO07523	FO07523	FO07523	FO07523	FO07523	FO07523

MOTO 125cc







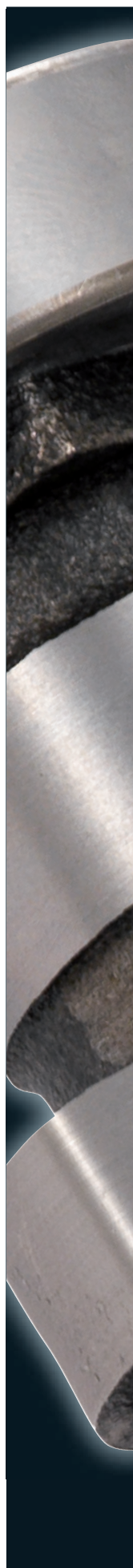









Motorhispania	Rieju	Rieju	Rieju	Rieju	Yamaha	
RX-R	Marathon	Marathon Pro	Marathon Pro Competition	RS3	MT 125	
08-08	09-09	09-09	11-11	11-11	15-15	
125cc 4T-4V LC	125cc 4T-4V LC	125cc 4T-4V LC	125cc 4T-4V LC	125cc 4T-4V LC	125cc 4T 4V IE LC	
Minarelli - Yamaha MC 125	Minarelli - Yamaha MC 125	Minarelli - Yamaha MC 125	Minarelli - Yamaha MC 125	Minarelli - Yamaha MC 125	Minarelli - Yamaha MC 125	
ALBERO A CAMME		9927230	9927230	9927230	9927230	9927230
GRUPPO TERMICO ø standard		9932700	9932700	9932700	9932700	9932700
GRUPPOTERMICO ø maggiorato		9927120	9927120	9927120	9927120	9927120
GRUPPO TERMICO ø maggiorato con centralina						
MOLLE FRIZIONE		9927810	9927810	9927810	9927810	9927810
SCARICO						
FILTRO OLIO		FO07523	FO07523	FO07523	FO07523	FO07523

Yamaha	Yamaha	Yamaha	Yamaha	Yamaha	Yamaha	Yamaha	Yamaha	Yamaha	Yamaha
MT 125 A	WR-R IE	WR-X IE	WR-X IE	YZF-R A IE	YZF-R IE	YZF-R IE	YZF-R IE	YZF-R IE	YZF-R IE
15-15	09-11	09-11	13-14	15-15	08-11	12-12	13-13	14-14	15-15
125cc 4T 4V IE LC	125cc 4T 4V IE LC	125cc 4T 4V IE LC	125cc 4T 4V IE LC	125cc 4T 4V IE LC	125cc 4T 4V IE LC	125cc 4T 4V IE LC	125cc 4T 4V IE LC	125cc 4T 4V IE LC	125cc 4T 4V IE LC
Minarelli - Yamaha MC 125	Minarelli - Yamaha MC 125	Minarelli - Yamaha MC 125	Minarelli - Yamaha MC 125	Minarelli - Yamaha MC 125	Minarelli - Yamaha MC 125	Minarelli - Yamaha MC 125	Minarelli - Yamaha MC 125	Minarelli - Yamaha MC 125	Minarelli - Yamaha MC 125
9927230	9927230	9927230	9927230	9927230	9927230	9927230	9927230	9927230	9927230
9932700	9932700	9932700	9932700	9932700	9932700	9932700	9932700	9932700	9932700
	9927260	9927260	9927260		9926900	9926900	9926900		
9927810	9927810	9927810	9927810	9927810	9927810	9927810	9927810	9927810	9927810
					9927350	9927350	9927350		
FO07523	FO07523	FO07523	FO07523	FO07523	FO07523	FO07523	FO07523	FO07523	FO07523



















	Dinli	Dinli	Dinli	E-Ton	Gilera	Keeway
	Helix DL603	Helix DL603 90	T-Rex	Viper RXL	Oregon 250	ATV 50 EC2
	-00	-00	-00	-00	06-10	06-06
	50cc 2T AC	50cc 2T AC	50cc 2T AC	50cc 2T AC	250cc 4T LC	50cc 2T AC
						Motore Keeway
ALBERO MOTORE						IM07065
CAMPANA + FRIZIONE		9925130	9925130	9925130	9925130	9925130
CINGHIE DI TRASMISSIONE	 Top	9907900	9907900	9907900	9907900	9913280
	 Mitsuboshi	9935340	9935340	9935340	9935340	9935800
CONVERTITORE DI COPPIA						9923030
GRUPPO TERMICO ø STANDARD		9931140		9931140	9931140	9925650
GRUPPO TERMICO MAGGIORATO C/ TESTA		9931340		9931340	9931340	9924890
INGRANAGGIO						
RUOTA LIBERA						
KIT CUSCINETTI E PARAOLI						
KIT REVISIONE POMPA ACQUA					AA00828	
MOTORINO D'AVVIAMENTO					MA00016	
VALVOLA LAMELLARE		9908370	9908370	9908370	9908370	9908370
VARIOTOP TPR						9924900

Keeway	Kymco	Kymco	Kymco	Kymco	Kymco	Kymco	Kymco	Kymco	Kymco	Kymco
ATV OFF ROAD	KXR 250	KXR 50	MXU 250	MXU 300	MXU 50	MXU R 300	MXU SR 50	Maxxer 300	Maxxer 50	Mxer 50
07-07	03-04	04-04	05-05	05-06	06-07	10-10	06-06	05-06	05-05	02-03
50cc 2T AC	250cc 4T LC	50cc 2T AC	250cc 4T LC	300cc 4T LC	50cc 2T AC	300cc 4T LC	50cc 2T AC	300cc 4T LC	50cc 2T AC	50cc 2T AC
Motore Keeway										
IM07065										
9925130										
9913280										
9935800										
9923030										
9925650										
9924890										
	RL00009		RL00009	RL00009		RL00031		RL00009		
	RL00008		RL00008	RL00008		RL00028		RL00008		
		KK01013			KK01013		KK01013		KK01013	KK01013
		MA00014			MA00014		MA00014		MA00014	MA00014
9908370										
9924900										



	Kymco	Laverda
	Mxer EU2 50	Quasar
	04-04	-00
	50cc 2T AC	50cc 2T AC
ALBERO MOTORE		
CAMPANA + FRIZIONE		9925130
CINGHIE DI TRASMISSIONE	 Top	9907900
	 Mitstuboshi	9935340
CONVERTITORE DI COPPIA		
GRUPPO TERMICO ø STANDARD		9931140
GRUPPO TERMICO MAGGIORATO C/ TESTA		9931340
INGRANAGGIO		
RUOTA LIBERA		
KIT CUSCINETTI E PARAOLI		KK01013
KIT REVISIONE POMPA ACQUA		
MOTORINO D'AVVIAMENTO		MA00014
VALVOLA LAMELLARE		9908370
VARIOTOP TPR		

gamma prodotti





◀ **cod. 9910780**
Variatore Peugeot con cinghia

APPLICABILITÀ

Peugeot Buxy 50 2T -00, Buxy RS 50 2T -00, Speedake 50 2T -00

RICAMBI

9910790	Cinghia Peugeot 755X18x30
9915530	Tasselli Di Traino Per Variatore Scooter Minarelli 50C

9915570	Sr. Masse Variatore ø 15 Gr.7,5
----------------	---------------------------------



◀ **cod. 9931260**
Variotop TROPHY "TPR" con cinghia per motore scooter 50 cc Piaggio masse Ø 19

APPLICABILITÀ

Piaggio Vespa ET2 iniezione 50 2T 97-00, Vespa ET4 50 4T 00-05, Vespa LX 2T 50 2T 05-08, Vespa LX 2T FL 50 2T 09-10, Vespa LX 2T Touring 50 2T 10-11, Vespa LX 4T 50 4T 05-08, Vespa LX 4T 4V 50 4T-4V 09-11, Vespa LX 4T 4V Touring 50 4T-4V 10-11, Vespa LXV 2T 50 2T -, Vespa LXV 2T NAVY 50 2T 08-08, Vespa S 2T & College 50 2T 07-12, Vespa S 4T 4V & College 50 4T-4V 08-11, Zip 2T 50 2T -, Zip 4T 50 4T 00-13, Zip LC 50 2T 00-04, Zip Sp 50 2T 96-04, Zip Sp Euro 2 50 2T

RICAMBI

9919990	Masse variatore ø 19x15,5 gr. 7
9922040	Cinghia di trasmissione
9930940	Puleggia anteriore mobile
9928400	Piattello portatasselli

9928410	Tasselli di traino
9923070	Distanziale

◀ **cod. 9931300**
Variotop TROPHY "TPR" con cinghia per motore scooter 50 cc Piaggio masse Ø 19

APPLICABILITÀ

Aprilia Mojito 50 2T -, SR R 50 2T 04-09, SR R FACTORY Carburatore 50 2T -, SR R FACTORY IE 50 2T -, SR Street Carburatore 50 2T 03-12

Derbi Atlantis 2T 50 2T 10-10, Atlantis 2T EU2 50 2T 07-09, Atlantis O2 50 2T 02-02, Atlantis O2 Bullet 50 2T 03-05, Atlantis O2 City 50 2T 03-06, Atlantis O2 Red Bullet 50 2T 03-03, Atlantis O2 Two Chic 50 2T 05-05, GP1 50 2T 01-03, GP1 EU2 50 2T 05-05, GP1 Open EU2 50 2T 06-09, GP1 Race EU2 50 2T 05-07

Gilera Ice 50 2T 01-05, Runner 50 2T 97-00, Runner Pure Jet 50 2T-IE 02-07, Runner Pure Jet 50 2T-IE 10-11, Runner SP 50 2T 02-04, Stalker 50 2T 97-11, Stalker Naked 50 2T 08-08, Stalker Special Edition 50 2T 07-08, Storm Euro 2 50 2T 07-07, Typhoon XR 50 2T 00-00

Piaggio Diesis 50 2T 01-01, NRG MC3 50 2T 01-04, NRG Power DD 50 2T 05-13, NRG Power DD Serie Speciale 50 2T -, NRG Power DT 50 2T 06-11, NRG Power DT Serie Speciale 50 2T 07-08, NRG Power Pure Jet 50 2T-IE 04-05, NRG Power PureJet 50 2T-IE 06-11, NRG PureJet 50 2T-IE 02-04, NRG PureJet 50 2T-IE 10-10, Typhoon 50 2T 01-11

RICAMBI

9919990	Masse variatore ø 19x15,5 gr. 7
9922030	Cinghia di trasmissione
9930940	Puleggia anteriore mobile
9928400	Piattello portatasselli

9928410	Tasselli di traino
9923070	Distanziale



cod. 9927610

Variotop TROPHY "TPR" con molla di contrasto per Piaggio 50cc con masse Ø 19

APPLICABILITÀ

Aprilia Mojito 50 2T -, SR R 50 2T 04-09, SR R FACTORY Carburatore 50 2T -, SR R FACTORY IE 50 2T -, SR Street Carburatore 50 2T 03-12, Scarabeo 2T EU2 Motore Piaggio 50 2T 10-12, Scarabeo 2T Net 50 2T 09-10, Scarabeo Street 50 2T 05-06, Scarabeo Street 2T Restyling 50 2T 06-09, Sport City One 2T 50 2T 08-11

Derbi Atlantis 2T 50 2T 10-10, Atlantis 2T EU2 50 2T 07-09, Atlantis O2 50 2T 02-02, Atlantis O2 Bullet 50 2T 03-05, Atlantis O2 City 50 2T 03-06, Atlantis O2 Red Bullet 50 2T 03-03, Atlantis O2 Two Chic 50 2T 05-05, Boulevard 50 2T 09-12, GP1 50 2T 01-03, GP1 EU2 50 2T 05-05, GP1 Open EU2 50 2T 06-09, GP1 Race EU2 50 2T 05-07, Sonar 2T 50 2T 09-09

Gilera DNA 50 2T 00-02, DNA 50 2T 05-07, DNA GP Experience 50 2T 03-04, Easy Moving 50 2T 95-96, Ice 50 2T 01-05, Runner 50 2T 97-00, Runner Poggiali 50 2T 02-02, Runner Pure Jet 50 2T-IE 02-07, Runner Pure Jet 50 2T-IE 10-11, Runner SP 50 2T 02-07, Runner SP 50 2T 10-12, Runner SP ST & Simoncelli 50 2T 08-09, Runner SP Special Edition 50 2T 07-07, Stalker 50 2T 97-11, Stalker Naked 50 2T 08-08, Stalker Special Edition 50 2T 07-08, Storm 50 2T 94-95, Storm Euro 2 50 2T 07-07, Typhoon 50 2T 94-97, Typhoon X 50 2T 98-99, Typhoon XR 50 2T 00-00

Italjet Jet Set 50 2T -00, Torpedo New 50 2T -00

Piaggio Diesis 50 2T 01-01, Fly 2T 50 2T 05-07, Fly 2T 50 2T 10-11, Fly 4T 50 4T 05-07, Fly 4T & 25-30 KM/H 50 4T 08-11, Fly 4T Motore CHN 50 4T 06-07, Free 50 2T 92-94, Free Delivery 50 2T 00-01, Free FL 50 2T 95-02, Liberty 50 2T 97-05, Liberty 2T 50 2T 06-08, Liberty 2T PTT EU2 50 2T 04-05, Liberty 2T RST 50 2T 04-04, Liberty 2T Sport 50 2T 06-08, Liberty MOC 2T & Elle 50 2T -, NRG 50 2T 94-96, NRG Extreme 50 2T 99-00, NRG MC3 50 2T 01-04, NRG Power DD 50 2T 05-13, NRG Power DD Serie Speciale 50 2T -, NRG Power DT 50 2T 06-11, NRG Power DT Serie Speciale 50 2T 07-08, NRG Power Pure Jet 50 2T-IE 04-05, NRG Power PureJet 50 2T-IE 06-11, NRG PureJet 50 2T-IE 02-04, NRG PureJet 50 2T-IE 10-10, NRG RST MC2 50 2T 96-98, NTT 50 2T 95-96, Quartz 50 2T 92-96, Sfera 50 2T 91-93, Sfera Maquillage 2 50 2T 94-94, Sfera RST 50 2T 95-97, Typhoon 50 2T 01-11, Typhoon 2T E2 50 2T 10-12, Typhoon 2T E3 CH 50 2T 11-11, Vespa ET2 50 2T 97-05, Vespa ET2 iniezione 50 2T 97-00, Vespa ET4 50 4T 00-05, Vespa LX 2T 50 2T 05-08, Vespa LX 2T FL 50 2T 09-10, Vespa LX 2T Touring 50 2T 10-11, Vespa LX 4T 50 4T 05-08, Vespa LX 4T 4V 50 4T 4V 09-11, Vespa LX 4T 4V Touring 50 4T 4V 10-11, Vespa LXV 2T 50 2T -, Vespa LXV 2T NAVY 50 2T 08-08, Vespa S 2T & College 50 2T 07-12, Vespa S 4T 4V & College 50 4T 4V 08-11, Zip 50 2T 92-93, Zip 50 2T 95-96, Zip 2T 50 2T -, Zip 4T 50 4T 00-13, Zip Bimodale 50 2T 94-97, Zip Fast Rider 50 2T 93-94, Zip Fast Rider RST 50 2T 96-97, Zip LC 50 2T 00-04, Zip RST 50 2T 96-99, Zip Sp 50 2T 96-04, Zip Sp Euro 2 50 2T

RICAMBI

9914450	Molle contrasto variatore
9919990	Masse variatore ø 19X15,5 gr. 7
9930940	Puleggia anteriore mobile
9928400	Piattello portatasselli

9928410	Tasselli di traino
9923070	Distanziale

cod. 9924900

Variotop "TPR" con molla di contrasto per Keeway - CPI 50 cc

APPLICABILITÀ

Benelli Pepe 50 2T 10-10, Pepe LX 50 2T 07-09, Pepe Old 50 2T 07-09, Pepe Old 50 2T 11-11, Quattrononex 50 2T 08-11

CPI Aragon 50 2T 03-03, Hussar 50 2T 03-03, Oliver 50 2T 03-03, Pop Corn 50 2T 03-03

Explorer Cracker 50 2T 03-03

Keeway ATV 50 EC2 50 2T 06-06, ATV OFF ROAD 50 2T 07-07, F-Act 50 2T 07-08, Flash 50 2T 07-08, Focus 50 2T 06-06, Goccia 50 2T 09-09, Hurrricane 50 2T 06-08, Matrix 50 2T 06-08, Pixel Euro 2 50 2T -00, RV8 50 2T 08-08

Malaguti F10 Wap Euro 2 50 2T -00, F12 R Phantom 50 2T 07-07

RICAMBI

9906140	Masse variatore ø 15X12 gr. 5,6
9915530	Tasselli di traino
9924920	Boccola

9924930	Piattello portatasselli
9925410	Puleggia anteriore mobile
9925420	Serie rasamenti

cod. 9926130

Variotop "TPR" Yamaha - MBK 50 cc 4T

APPLICABILITÀ

Mbk Booster X ie 50 4T-3V 08-08, Ovetto 4T 50 4T-3V 09-11

Yamaha Giggle 50 4T-3V 08-08, Neo's 4 50 4T-3V 09-11

RICAMBI

9912820	Kit rasamenti
9915520	Masse variatore ø 15X12 gr. 6,5
9915530	Tasselli di traino

9923130	Boccola
9926700	Cappellotto portatasselli



◀ **cod. 9931650**
Variotop Trophy "TPR" con molla di contrasto per scooter 50cc Minarelli/Yamaha
masse Ø 16

APPLICABILITÀ

Aprilia Amico 50 2T 94-94, Amico 50 2T 96-98, Amico GL/GLE 50 2T 93-95, Amico LX/Sport/Cat 50 2T 92-93, Area 51 50 2T 98-00, Gulliver 50 2T 95-98, Gulliver LC 50 2T 96-98, Rally 50 2T 95-03, Rally Liquid Cooled 50 2T 96-99, SR (Orizzontale) 50 2T 94-96, SR (Verticale) 50 2T 93-93, SR Liquid Cooled 50 2T 94-96, SR Recing 50 2T 97-99, SR Stealth 50 2T 97-99, SR WWW 50 2T 97-01, Scarabeo 50 2T 93-05, Sonic 50 2T 98-07, Sonic GP 50 2T 98-08

Atala Carosello 50 2T -00

Benelli 491 GT 50 2T 98-99, 491 RR 50 2T 99-01, 491 Racing 50 2T 98-99, 491 SP 50 2T 99-99, 491 ST 50 2T 99-01, 491 Sport 50 2T 98-99, K2 50 2T 98-01, K2 Liquid Cooled 50 2T 98-01, Naked 50 2T 02-02, Pepe 50 2T 99-01, Pepe LX 50 2T 03-04

Beta Ark 50 2T 96-08, Ark LC 50 2T 96-08, Chrono 50 2T 96-00, Eikon 50 2T 99-03, Quadra 50 2T 95-00, Tempo 50 2T 95-00

Italjet Dragster 50 2T -00

KTM K50 50 2T -00

Macal Thunder 50 2T -00

Malaguti Centro 50 2T -00, Ciak 50 2T -00, Ciak Euro 2,2,3 50 2T 03-03, Ciak Euro2 50 2T 01-03, Ciak Master Euro 2 50 2T 06-06, F10 50 2T -00, F10 Euro 2 50 2T -00, F10 Euro 2,2,3 50 2T 03-04, F10 Restyling Euro 2 50 2T 06-06, F12 Phantom 50 2T -00, F12 Phantom Euro 2 50 2T 02-02, F12 Phantom

Euro 2,2,3 50 2T 03-04, F12 Phantom LC 50 2T -00, F12 Phantom LC Euro 2,2,3 50 2T 03-04, F12 R Phantom LC 50 2T 07-07, F12 Restyling Euro 1 50 2T 99-02, F12 Restyling Euro 2 50 2T 06-06, F12 Restyling LC Euro 2 50 2T 06-06, F15 Firefox 50 2T -00, F15 Firefox Euro 2 50 2T 02-06, F15 Firefox Euro 2,2,3 50 2T 03-04, Yesterday 50 2T 97-00

Mbk

Booster 50 2T -00, Booster Euro 2 50 2T 04-04, Booster NG 50 2T 03-00, Booster Rocket 50 2T 97-98, Booster Spirit 50 2T 03-00, Booster Track 50 2T 96-98, Evolis 50 2T 92-95, Fizz 50 2T 94-95, Flipper 50 2T -00, Flipper Euro 2 50 2T 03-03, Forte 50 2T 94-96, Mach G 50 2T 02-04, Mach G LC 50 2T 02-04, Nitro 50 2T -00, Nitro Euro 2 50 2T 03-03, Ovetto 50 2T -00, Ovetto Euro 2 50 2T 02-02, Stunt 50 2T 00-02

Motron

Syncro 50 2T -00, Thunder 50 2T -00

Rieju

First 50 2T -00, Windy 50 2T -00

Yamaha

Aerox 50 2T -00, Aerox Euro 2 50 2T 03-03, Axis 50 2T 95-96, BWS 50 2T -00, BWS Bump 50 2T 97-98, BWS Euro 2 50 2T 03-03, BWS NG 50 2T -00, BWS NG Euro 2 50 2T 03-03, Breeze 50 2T 94-95, Jog 50 2T -00, Jog R 50 2T 02-10, Jog R LC 50 2T -00, Neo's 50 2T -00, Neo's Euro 2 50 2T 02-02, Slider 50 2T 00-02, Spy 50 2T 95-98, Why 50 2T -00, Why Euro 2 50 2T 03-03, Zest 50 2T -00, Zuma 50 2T 97-01

RICAMBI

9914370	Serie massette Ø 16 Gr. 7
9914470	Molla contrasto carico 26 kg
9915460	Dado con rondella conica
9915470	Scodellino dentato
9915480	Piastrina traino
9916790	Distanziale

9931660	Puleggia mobile anteriore
9928580	Cappellotto porta tasselli
9931350	Tasselli di traino
9931380	Boccola
9931360	Spessore ø 13,2x22x1,8



◀ **cod. 9931670**
Variotop Trophy "TPR" scooter 50cc Minarelli/Yamaha verticale/orizzontale lungo e F12 2000 -
masse Ø 16

APPLICABILITÀ

Aprilia Amico 50 2T 94-94, Amico 50 2T 96-98, Amico GL/GLE 50 2T 93-95, Amico LX/Sport/Cat 50 2T 92-93, Area 51 50 2T 98-00, Gulliver 50 2T 95-98, Gulliver LC 50 2T 96-98, Rally 50 2T 95-03, Rally Liquid Cooled 50 2T 96-99, SR (Orizzontale) 50 2T 94-96, SR (Verticale) 50 2T 93-93, SR Liquid Cooled 50 2T 94-96, SR Recing 50 2T 97-99, SR Stealth 50 2T 97-99, SR WWW 50 2T 97-01, Scarabeo 50 2T 93-05

Atala Carosello 50 2T -00

Benelli 491 GT 50 2T 98-99, 491 RR 50 2T 99-01, 491 Racing 50 2T 98-99, 491 SP 50 2T 99-99, 491 ST 50 2T 99-01, 491 Sport 50 2T 98-99, K2 50 2T 98-01, K2 Liquid Cooled 50 2T 98-01, Naked 50 2T 02-02, Pepe 50 2T 99-01, Pepe LX 50 2T 03-04

Beta Ark 50 2T 96-08, Ark LC 50 2T 96-08, Chrono 50 2T 96-00, Eikon 50 2T 99-03, Quadra 50 2T 95-00, Tempo 50 2T 95-00

Italjet Dragster 50 2T -00

KTM K50 50 2T -00

Macal Thunder 50 2T -00

Malaguti Centro 50 2T -00, Ciak 50 2T -00, Ciak Euro 2,2,3 50 2T 03-03, Ciak Euro2 50 2T 01-03, Ciak Master Euro 2 50 2T 06-06, F12 Phantom 50 2T -00, F12 Phantom Euro 2 50 2T 02-02, F12 Phantom Euro 2,2,3 50 2T 03-04, F12 Phantom LC 50 2T -00, F12 Phantom LC Euro 2,2,3 50 2T 03-04, F12 R Phantom LC 50 2T 07-07, F12 Restyling Euro 1 50 2T 99-02, F12 Restyling Euro 2 50 2T 06-06, F12 Restyling LC Euro 2 50 2T 06-06, F15 Firefox 50 2T -00, F15 Firefox Euro 2 50 2T 02-06, F15 Firefox Euro 2,2,3 50 2T 03-04

Mbk

Booster 50 2T -00, Booster Euro 2 50 2T 04-04, Booster NG 50 2T 03-00, Booster Rocket 50 2T 97-98, Booster Spirit 50 2T 03-00, Booster Track 50 2T 96-98, Flipper 50 2T -00, Flipper Euro 2 50 2T 03-03, Mach G 50 2T 02-04, Mach G LC 50 2T 02-04, Nitro 50 2T -00, Nitro Euro 2 50 2T 03-03, Ovetto 50 2T -00, Ovetto Euro 2 50 2T 02-02, Stunt 50 2T 00-02

Motron

Syncro 50 2T -00, Thunder 50 2T -00

Rieju

First 50 2T -00, Windy 50 2T -00

Yamaha

Aerox 50 2T -00, Aerox Euro 2 50 2T 03-03, BWS 50 2T -00, BWS Bump 50 2T 97-98, BWS Euro 2 50 2T 03-03, BWS NG 50 2T -00, BWS NG Euro 2 50 2T 03-03, Jog R 50 2T 02-10, Jog R LC 50 2T -00, Neo's 50 2T -00, Neo's Euro 2 50 2T 02-02, Slider 50 2T 00-02, Spy 50 2T 95-98, Why 50 2T -00, Why Euro 2 50 2T 03-03, Zuma 50 2T 97-01

RICAMBI

9907770	Cinghia racing
9914370	Serie massette Ø 16 Gr. 7
9915460	Dado con rondella conica
9915470	Scodellino dentato
9915480	Piastrina traino
9916790	Distanziale

9931660	Puleggia mobile anteriore
9928580	Cappellotto porta tasselli
9931350	Tasselli di traino
9931380	Boccola
9931360	Spessore ø 13,2x22x1,8



cod. **9931690**
Variatop Trophy "TPR" scooter 50cc Minarelli/Yamaha orizzontale corto (f10)
masse Ø 16

APPLICABILITÀ

Aprilia Sonic 50 2T 98-07, Sonic GP 50 2T 98-08
Malaguti F10 50 2T -00, F10 Euro 2 50 2T -00, F10 Euro 2 2,3 50 2T 03-04, F10 Restyling Euro 2 50 2T 06-06, Yesterday 50 2T 97-00

Mbk Evolis 50 2T 92-95, Fizz 50 2T 94-95, Forte 50 2T 94-96
Yamaha Axis 50 2T 95-96, Breeze 50 2T 94-95, Jog 50 2T -00, Zest 50 2T -00

RICAMBI

9907900	Cinghia racing
9914370	Serie massette Ø 16 Gr. 7
9915460	Dado con rondella conica
9915470	Scodellino dentato
9915480	Piastrina traino
9931660	Puleggia mobile anteriore

9928580	Cappello porta tasselli
9931350	Tasselli di traino
9931380	Boccola
9931360	Spessore ø 13,2x22x1,8



cod. **9915540**
Piattello portatasselli inclinazione 67° per variatore Minarelli/Yamaha 50 cc

APPLICABILITÀ

Aprilia Amico 50 2T 94-94, Amico 50 2T 96-98, Amico GL/GLE 50 2T 93-95, Amico LX/Sport/Cat 50 2T 92-93, Area 51 50 2T 98-00, Gulliver 50 2T 95-98, Gulliver LC 50 2T 96-98, Rally 50 2T 95-03, Rally Liquid Cooled 50 2T 96-99, SR (Orizzontale) 50 2T 94-96, SR (Verticale) 50 2T 93-93, SR Liquid Cooled 50 2T 94-96, SR Recing 50 2T 97-99, SR Stealth 50 2T 97-99, SR WWW 50 2T 97-01, Scarabeo 50 2T 93-05, Sonic 50 2T 98-07, Sonic GP 50 2T 98-08

Atala Carosello 50 2T -00
Benelli 491 GT 50 2T 98-99, 491 RR 50 2T 99-01, 491 Racing 50 2T 98-99, 491 SP 50 2T 99-99, 491 ST 50 2T 99-01, 491 Sport 50 2T 98-99, K2 50 2T 98-01, K2 Liquid Cooled 50 2T 98-01, Naked 50 2T 02-02, Pepe 50 2T 99-01, Pepe LX 50 2T 03-04

Beta Ark 50 2T 96-08, Ark LC 50 2T 96-08, Chrono 50 2T 96-00, Eikon 50 2T 99-03, Quadra 50 2T 95-00, Tempo 50 2T 95-00

Italjet Dragster 50 2T -00
KTM K50 50 2T -00
Macal Thunder 50 2T -00

Malaguti Centro 50 2T -00, Ciak 50 2T -00, Ciak Euro 2 2,3 50 2T 03-03, Ciak Euro2 50 2T 01-03, Ciak Master Euro 2 50 2T 06-06, F10 50 2T -00, F10 Euro 2 50 2T -00, F10 Euro 2 2,3 50 2T 03-04, F10 Restyling Euro 2 50 2T 06-06, F12 Phantom 50 2T -00, F12 Phantom Euro 2 50 2T 02-02, F12 Phantom

Euro 2 2,3 50 2T 03-04, F12 Phantom LC 50 2T -00, F12 Phantom LC Euro 2 2,3 50 2T 03-04, F12 R Phantom LC 50 2T 07-09, F12 Restyling Euro 1 50 2T 99-02, F12 Restyling Euro 2 50 2T 06-06, F12 Restyling LC Euro 2 50 2T 06-06, F15 Firefox 50 2T -00, F15 Firefox Euro 2 50 2T 02-06, F15 Firefox Euro 2 2,3 50 2T 03-04, Yesterday 50 2T 97-00

Mbk Booster 50 2T -00, Booster Euro 2 50 2T 04-04, Booster NG 50 2T 03-00, Booster Rocket 50 2T 97-98, Booster Spirit 50 2T 03-00, Booster Track 50 2T 96-98, Evolis 50 2T 92-95, Fizz 50 2T 94-95, Flipper 50 2T -00, Flipper Euro 2 50 2T 03-03, Forte 50 2T 94-96, Mach G 50 2T 02-04, Mach G LC 50 2T 02-04, Nitro 50 2T -00, Nitro Euro 2 50 2T 03-03, Ovetto 50 2T -00, Ovetto Euro 2 50 2T 02-02, Stunt 50 2T 00-02

Motron Syncro 50 2T -00, Thunder 50 2T -00
Rieju First 50 2T -00, Windy 50 2T -00

Yamaha Aerox 50 2T -00, Aerox Euro 2 50 2T 03-03, Axis 50 2T 95-96, BWS 50 2T -00, BWS Bump 50 2T 97-98, BWS Euro 2 50 2T 03-03, BWS NG 50 2T -00, BWS NG Euro 2 50 2T 03-03, Breeze 50 2T 94-95, Jog 50 2T -00, Jog R 50 2T 02-10, Jog R LC 50 2T -00, Neo's 50 2T -00, Neo's Euro 2 50 2T 02-02, Slider 50 2T 00-02, Spy 50 2T 95-98, Why 50 2T -00, Why Euro 2 50 2T 03-03, Zest 50 2T -00, Zuma 50 2T 97-01



cod. **9922430**
Variatop "TPR" Suzuki AN Burgman 400 K3/K6

APPLICABILITÀ

Benelli Velvet Dusk 400 400 4T 03-04
Malaguti Madison K 400 400 4T 02-02

Suzuki AN Burgman 400 K3/K6 400 4T 03-06

RICAMBI

9922350	Serie 8 masse variatore ø 26x12,9 gr. 16
9922390	Serie 8 masse variatore ø 26x12,9 gr. 18

9922870	Boccola
---------	---------



cod. **9923250**
Variatop "TPR" Piaggio Beverly 500 cc

APPLICABILITÀ

Aprilia Atlantic 500 500 4T 01-04, Atlantic Arrecife 500 500 4T 05-08, Atlantic Sprint 500 500 4T 05-08, Scarabeo 500 500 4T 03-06, Scarabeo Light 500 500 4T 06-08
Gilera Fuoco 500 IE EU3 500 4T 07-13, Nexus 500 500 4T 03-05
Malaguti Spider Max 500 GT 500 4T 04-05, Spider Max 500 GT EU3 500 4T 06-06, Spider Max RS 500 500 4T 08-08

Peugeot Geopolis 500 IE EU3 500 4T 4V -00, Satelis 500 EU3 500 4T -00

Piaggio Beverly 500 500 4T 02-06, Beverly 500 ie EU3 500 4T 06-08, Beverly Cruiser 500 500 4T 07-11, MP3 500 LT Sport/Business 500 4T -, MP3 500 RL Sport 500 4T -, X9 500 500 4T 01-02, X9 Evolution 500 500 4T 03-07, X9 Evolution ABS 500 500 4T 06-07

RICAMBI

9923270	Boccola
9923280	Tasselli
9923290	Piattello portatasselli

9924530	Serie 8 masse variatore ø 25x17 gr. 16
9924550	Serie 8 masse variatore ø 25x17 gr. 17



cod. **9923330**
Variotop "TPR" Yamaha Majesty 400 2004-2008

APPLICABILITÀ

Yamaha Majesty 400 400 4T 04-08, Majesty 400 ABS 400 4T 07-08

RICAMBI

9923340	Boccola
9924610	Serie 8 masse variatore ø 25x15 gr. 11

9924630	Serie 8 masse variatore ø 25x15 gr. 12
----------------	--



cod. **9923410**
Variotop "TPR" Honda SH 125/150 cc fino al 2012

APPLICABILITÀ

Honda @ [NES] 125 125 4T 00-06, Bali 125 125 4T -00, Dylan 125 [SES] 125 4T 02-04, PS I 125 [PES] 125 4T 06-10, Pantheon 125 IE [FES] 125 4T-2V 03-05, SH 125 125 4T-2V 01-04, SH IE 125 Scoopy 125 4T-2V 05-12, Silver Wing 125 [FES] 125 4T-2V 07-12, @ [NES] 150 150 4T 00-06, Bali 150 150 4T -00, Dylan 150 [SES] 150 4T 02-04, PS I 150 [PES] 150 4T 06-10, Pantheon 150 IE [FES] 150 4T-2V 03-05, SH 150 150 4T-2V 01-04, SH IE 150 Scoopy 150 4T 05-12, Silver Wing 150 [FES] 150 4T-2V 07-12

Keeway Outlook 125 125 4T 07-08, Outlook 150 150 4T 07-08

RICAMBI

9916650	Serie 6 masse variatore ø 20x15 gr. 10
9916670	Serie 6 masse variatore ø 20x15 gr. 11

9923440	Boccola
----------------	---------



cod. **9923460**
Variotop "TPR" Suzuki Burgman 125/150 cc

APPLICABILITÀ

Suzuki Epicuro 125 125 4T 99-01, UH Burgman 125 K2/K6 125 4T 02-06, UH Burgman 125 K7/L0 125 4T 07-10, UX Sixteen 125 K8/L0 125 4T 08-10, Epicuro 150 150 4T 99-01, UH Burgman 150 K2/K6 150 4T 02-06, UX Sixteen 150 K8/L0 150 4T 08-10

RICAMBI

9923480	Tasselli di traino
9923510	Serie 6 masse variatore ø 20x17 gr. 10
9923520	Piattello portatasselli

9923540	Boccola
9923590	Serie 6 masse variatore ø 20x17 gr. 9



◀ **cod. 9923550**
Variotop "TPR" Yamaha Majesty 125/150/180 cc

APPLICABILITÀ

Benelli Velvet 125 125 4T 99-01, Velvet 150 150 4T 99-01
Italjet Jupiter 125 125 4T -00, Millenium 125 125 4T -00, Jupiter 150 150 4T -00, Millenium 150 150 4T -00
Malaguti Madison 125 125 4T 99-01, Madison R Restyling 125 125 4T 02-02, Madison R Restyling 125 EU2 125 4T 03-04, Phantom Max 125 125 4T 03-03, Madison T 150 150 4T 99-01

Mbk Doodo 125 125 4T 00-00, Skyliner 125 125 4T 98-02, Skyliner E 125 125 4T 03-03, Thunder 125 125 4T 01-02, Doodo 150 150 4T 01-02, Skyliner 150 150 4T 00-02, Thunder 150 150 4T 01-02, Skyliner E 180 180 4T 03-03
Yamaha Majesty 125 125 4T 98-02, Majesty 125 E 125 4T 03-09, Maxter 125 125 4T 01-02, Teo's 125 125 4T 00-00, Majesty 150 150 4T 00-02, Maxter 150 150 4T 01-02, Teo's 150 150 4T 01-02, Majesty 180 E 180 4T 03-06

RICAMBI

9923480	Tasselli di traino
9923510	Serie 6 masse variatore ø 20x17 gr. 10
9923560	Boccola

9923570	Piattello portatasselli
9923590	Serie 6 masse variatore ø 20x17 gr. 9



◀ **cod. 9923600**
Variotop "TPR" Piaggio Beverly 125 cc

APPLICABILITÀ

Aprilia Atlantic 125 125 4T 03-05, Atlantic 125 EU3 125 4T 06-08, Atlantic 125 EU3 125 4T 10-12, Atlantic Arrecife 125 125 4T -00, Mojito 125 125 4T 03-08, SR MAX 125 125 4T 11-14, SR Motard 125 125 4T-2V 12-12, Scarabeo 125 125 4T 03-06, Scarabeo EU3 125 125 4T 06-07, Scarabeo IE Light 125 125 4T 09-12, Scarabeo Light 125 125 4T 07-08, Sport City Street 125 125 4T 12-12, Sportcity 125 125 4T 04-06, Sportcity 125 EU3 125 4T 06-08, Sportcity Cube 125 125 4T 08-10, Sportcity One 4T EU3 125 125 4T 08-11, Mojito 150 150 4T 03-07, Scarabeo 150 150 4T 04-06, Scarabeo IE Light 200 200 4T 11-12
Benelli Adiva 125 125 4T 01-02, Adiva 150 150 4T 01-02
Derbi Boulevard 125 125 4T 02-04, GP1 125 EU 2 125 4T 06-06, Rambla 125 125 4T 08-09, Boulevard 150 150 4T 02-04
Gilera DNA 125 125 4T 01-01, Nexus 125 EU3 125 4T 07-08, Nexus 125 IE EU3 125 4T 08-10, Runner VX 125 125 4T 00-06, Runner 180 180 4T 00-01, Runner VXR 180 180 4T 00-01
Italjet Jet Set 125 125 4T -00, Torpedo 125 125 4T -00, Jet Set 150 150 4T -00, Torpedo 150 150 4T -00
Malaguti Madison 3 125 125 4T 06-09
Piaggio Beverly 125 125 4T 01-03, Beverly 125 EU3 125 4T 07-08, Beverly 125 EURO 3 MIC 125 4T 07-07, Beverly 125 EURO 3 SPORT 125 4T 07-08, Beverly 125 RST 4T 4V IE EU3 125 4T 10-15, Beverly 125 Tourer EU3 125 4T 07-10, Beverly RST 125 125 4T 04-07, Carnaby 125 125 4T 07-10, Fly 125 125 4T 05-07, Hexagon GTX 125 125 4T 00-00, Liberty 125 125 4T 98-02, Liberty RST 125 125 4T 04-05, MP3 125 125 4T 06-08, MP3 125 IE 125 4T 08-09, MP3 125 IE Touring 125 4T 11-12, MP3 125 Ibrido 125 4T 09-10, MP3 125 Yourban ERL 125 4T 11-11, Skyyper 125 4T 125 4T 00-02, Super Hexagon GTX 12 125 125 4T 01-02, Vespa ET4 125 125 4T 96-02, Vespa GRANTURISMO 125 125 4T 03-07,

Vespa GRANTURISMO 125 EU3 125 4T 06-07, Vespa GTS 125 EU3 125 4T 07-12, Vespa GTS 4T IE SUPER 125 4T 09-16, Vespa GTV 125 125 4T 06-08, Vespa GTV 4T NAVY EU3 125 125 4T 08-08, Vespa LX 125 125 4T 05-06, Vespa LX 4T EU3 TOURING 125 4T 10-11, Vespa LX 4T FL 125 4T 09-09, Vespa LX EU3 125 4T 06-08, Vespa LX EU3 IE 125 4T 09-10, Vespa LXV 4T EU3 125 4T 06-09, Vespa LXV IE 4T 125 4T 10-12, Vespa LXV NAVY EU3 125 4T 07-08, Vespa S 4T 125 4T 07-08, Vespa S 4T IE & COLLEGE 125 4T 09-11, X-Evo 125 125 4T 07-16, X7 125 EU3 125 4T 08-08, X7 Evo 125 IE EU3 125 4T 09-10, X8 125 125 4T 04-06, X8 125 Premium EU2 125 4T 06-06, X8 125 Premium EU3 125 4T 06-07, X9 125 125 4T 01-02, X9 Evolution 125 125 4T 03-03, X9 Evolution 125 125 4T 05-06, X9 Evolution EU3 125 125 4T 07-07, Zip 125 125 4T 00-02, Fly 150 150 4T 05-07, Liberty 150 150 4T 01-02, Skyyper 150 4T 150 4T 00-02, Vespa ET4 150 150 4T 99-02, Vespa LX 150 150 4T 05-06, Vespa LX 4T FL 150 4T 09-09, Vespa LX EU3 150 4T 06-08, Vespa LX EU3 IE 150 4T 09-11, Vespa LX TOURING 150 4T 10-12, Vespa S 4T 150 150 4T 08-09, Vespa S 4T IE & COLLEGE 150 4T 09-11, X8 Street 150 EU2 150 4T 06-08, Super Hexagon GTX 12 180 180 4T 01-02, Liberty RST 200 200 4T 04-04

Renault Fulltime 125 125 4T -00

RICAMBI

9923480	Tasselli di traino
9923590	Serie 6 masse variatore ø 20x17 gr. 9
9923620	Serie 6 masse variatore ø 20x17 gr. 14

9923630	Piattello portatasselli
9923640	Boccola



◀ cod. **9923650**
Variotop "TPR" Piaggio Beverly 200/250 cc

APPLICABILITÀ

- Aprilia** Atlantic 200 200 4T 03-05, Atlantic Arrecife 200 200 4T -00, Scarabeo EU3 200 200 4T 06-07, Scarabeo Light 200 200 4T 07-08, Sportcity 200 200 4T 04-06, Sportcity 200 EU3 200 4T 06-08, Atlantic 250 EU3 250 4T 06-08, Atlantic Arrecife 250 250 4T -00, Scarabeo 250 250 4T 04-06, Scarabeo Light 250 250 4T 06-08, Sportcity 250 250 4T -00, Sportcity 250 EU3 250 4T 06-08, Sportcity Cube 250 250 4T 08-12, Atlantic 300 300 4T 10-11, SR MAX 300 300 4T 11-14, Scarabeo Light 300 300 4T 09-10, Sportcity Cube 300 300 4T 08-10, Sprot City Street 300 300 4T-4V 12-12
- Benelli** Adiva 250 EU2 250 4T -00
- Derbi** Boulevard 200 EU2 200 4T 05-06, GP1 250 250 4T 06-07, Rambla 250 EU3 2VER 250 4T 08-08
- Gilera** Runner VXR 200 200 4T 02-06, Nexus 250 EU3 250 4T 06-07, Nexus 300 EU3 300 4T 08-11
- Malaguti** Madison R 180 180 4T 01-02, Madison S Restyling 200 200 4T 02-02, Phantom Max 200 200 4T 03-03, Madison 3 250 250 4T 06-09, Madison RS 250 250 4T 04-04, Phantom Max 250 250 4T 04-04
- Peugeot** Geopolis 250 IE EU3 250 4T-4V -00, Satelis 250 EU3 250 4T -00

- Piaggio** Beverly 200 200 4T 01-03, Carnaby 200 200 4T 07-08, Liberty 200 200 4T 06-06, Liberty 200 4T Sport EU3 200 4T 06-07, Vespa GRANTURISMO 200 200 4T 03-07, Vespa GTS 200 EU3 200 4T -00, Vespa GTV 200 EU3 200 4T -00, X8 200 200 4T 04-07, X9 200 200 4T 02-03, Beverly 250 250 4T 06-07, Beverly 250 ie EU3 250 4T 06-08, Beverly RST 250 250 4T 04-05, Carnaby 250 250 4T 08-08, MP3 250 250 4T 06-08, MP3 250 LT 250 4T 08-09, MP3 250 MIC 250 4T 08-09, Vespa GT 60 250 EU3 250 4T 06-07, Vespa GTS 250 250 4T 05-16, Vespa GTS ABS 250 250 4T 05-12, Vespa GTV 250 250 4T 06-09, Vespa GTV 4T NAVY EU3 250 250 4T 07-07, X-Evo 250 250 4T 07-16, X7 250 EU3 250 4T 08-08, X8 250 EU3 250 4T 05-08, X9 Evolution 250 250 4T 04-04, X9 Evolution 250 250 4T 06-06, Beverly Tourer 300 EU3 300 4T 09-10, Carnaby Cruiser 300 300 4T 09-12, MP3 300 4T 4V IE LT Ibrido 300 4T 10-11, MP3 300 IE LT 300 4T 10-11, MP3 300 IE LT Touring 300 4T 11-13, MP3 300 IE LT/Sport 300 4T 11-14, MP3 300 IE MIC 300 4T 10-11, MP3 300 IE Touring 300 4T 11-12, MP3 300 Yourban ERL 300 4T 11-15, MP3 300 Yourban LT ERL 300 4T 11-12, Vespa GTS Super 300 4T 08-15, X7 Evo 300 IE EU3 300 4T 09-10

RICAMBI

9924450	Serie 6 masse variatore ø 20x17 gr. 12
9923480	Tasselli di traino
9923620	Serie 6 masse variatore ø 20x17 gr. 14

9923630	Piattello portatasselli
9923660	Boccola



◀ cod. **9923670**
Variotop "TPR" Kymco 250 cc

APPLICABILITÀ

- Kymco** B&W 250 250 4T 00-00, Grand Dink 250 250 4T 01-02, People LC 250 250 4T 03-04, People S 250 250 4T 06-06, People S 250 I 250 4T 07-07, Xciting 250 250 4T 05-05, Xciting 250 I 250 4T 06-07, Yup 250 250 4T 03-03

RICAMBI

9923700	Serie 6 masse variatore ø 23x18 gr. 20
9923710	Piattello portatasselli
9923720	Tasselli

9923740	Boccola
9923770	Serie 6 masse variatore ø 23x18 gr. 18



◀ cod. **9923750**
Variotop "TPR" Honda Foresight 250 cc

APPLICABILITÀ

- Honda** Foresight 250 [FES] 250 4T 98-99

- Piaggio** X9 250 250 4T 00-01

RICAMBI

9923770	Serie 6 masse variatore ø 23x18 gr. 18
9923780	Boccola

9924470	Serie 6 masse variatore ø 23x18 gr. 16
---------	--



◀ cod. **9923790**
Variotop "TPR" Suzuki AN 250 cc

APPLICABILITÀ

- Suzuki** AN Burgman 250 K3/K6 250 4T 03-06, AN Burgman 250 W/K2 250 4T 98-02

RICAMBI

9923720	Tasselli
9923810	Serie 6 masse variatore ø 23x18 gr. 15
9923820	Cappellotto porta tasselli

9923830	Boccola
---------	---------



◀ cod. **9924760**
Variotop "TPR" Piaggio Beverly 400 cc

APPLICABILITÀ

Aprilia Atlantic Arrecife 400 400 4T -00, Atlantic Sprint 400 400 4T 05-08, Scarabeo Light 400 400 4T 06-08

Peugeot Geopolis 400 IE EU3 400 4T-4V -00, Satelis 400 EU3 400 4T -00

Piaggio

Beverly 400 EU3 400 4T 06-07, Beverly Tourer 400 EU3 400 4T 08-10, MP3 400 400 4T 07-08, MP3 400 IE LT Touring 400 4T 11-11, MP3 400 IE LT/Sport 400 4T 08-10, MP3 400 MIC 400 4T 08-10, MP3 400 RL Touring 400 4T 11-11, X-Evo 400 400 4T 07-11, X8 400 EU3 400 4T 06-08

RICAMBI

9923270	Boccola
9923280	Tasselli

9923290	Piattello portatasselli
9924490	Serie 8 masse variatore ø 25x17 gr. 14



◀ cod. **9925020**
Variotop "TPR" Yamaha X-Max 125 cc

APPLICABILITÀ

Mbk Cityliner 125 EU3 125 4T-4V 08-10, Skycruiser 125 125 4T-4V 07-07

Yamaha

X-City 125 EU3 125 4T-4V 08-11, X-Max R 125 125 4T-4V 06-16, X-Max R 125 ABS 125 4T-4V 11-11, X-Max RA 125 ABS 125 4T-4V 13-16

RICAMBI

9918060	Serie 8 masse variatore ø 20x12 gr. 12
---------	--

9925270	Boccola
---------	---------



◀ cod. **9926010**
Variotop "TPR" Suzuki Burgman 400 cc K7

APPLICABILITÀ

Suzuki AN Burgman 400 K7/L0 400 4T 07-10

RICAMBI

9922340	Serie 8 masse variatore ø 26x12,9 gr. 16
9927310	Serie 8 masse variatore ø 26x12,9 gr. 14

9923850	Serie rasamenti
9926030	Boccola



◀ cod. **9926040**
Variotop "TPR" Honda SH 300 cc

APPLICABILITÀ

Honda SH IE 300 Scoopy 300 4T-4V 07-16

RICAMBI

9923800	Serie 6 masse variatore ø 23x18 gr. 15
---------	--



◀ **cod. 9927130**
Variotop "TPR" Yamaha T-Max 500 cc 530 cc

APPLICABILITÀ

Yamaha T-Max 4BS 500 500 4T 09-11, T-Max 4BS ABS 500 500 4T 08-11, T-Max 5GJ 500 500 4T 01-03, T-Max 5VU 500 500 4T 04-08, T-Max 5VU ABS 500 500 4T 05-07, T-Max 5VU BLACK MAX 500 4T 06-06, T-Max 5VU BLACK MAX - NIGHT MAX 500 4T 07-07, T-Max 59C 530 530 4T 12-16, T-Max 59C 530 ABS 530 4T 12-16, T-Max 59C 530 SP 530 4T 15-15, T-Max 59C 530 SP ABS 530 4T 15-16

A RICAMBIO PER

9931500	Kit Variotop + Exhaust System Lv One T-Max 530
---------	--

RICAMBI

9922090	Boccola	9926840	Serie rasamenti
9922150	Serie masse Ø 25x15 gr.15	9927140	Cappello porta tasselli
9922170	Serie masse Ø 25x15 gr.16	9927150	Tasselli di traino



◀ **cod. 9927830**
Variotop "TPR" Kymco Agility 125 cc

APPLICABILITÀ

Kymco Agility 125 125 4T 06-06, Agility 125 R16 125 4T 08-09, Agility 125 RS 125 4T 09-09, Movie 125 EU3 125 4T 06-07, People 125 125 4T 99-00, People 125 EU3 125 4T 07-08, People S 125 125 4T 05-05, Super 8 125 125 4T 08-09, Vivio 125 125 4T 00-00, Agility 150 150 4T 06-08, Agility 150 R16 150 4T 08-09, People 150 150 4T 99-00, Vivio 150 150 4T 00-00, Agility 200i R16 200 4T 10-10, Agility R16 200 4T 12-12, Like 200 IE 200 4T 09-09, Like LX 200 4T 12-12

Malaguti Ciak Master 125 125 4T 04-04, Ciak Master 150 150 4T 04-04, Ciak Master 200 EU2 200 4T 06-06

RICAMBI

9922570	Serie 6 masse variatore ø 20x17 gr. 13,0	9927840	Boccola
9923480	Tasselli di traino	9927860	Cappello porta tasselli

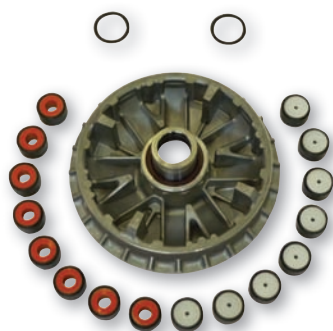

◀ **cod. 9930360**
Variotop "TPR" Yamaha Majesty 400 cc 2009

APPLICABILITÀ

Yamaha Majesty 400 400 4T 09-11, Majesty 400 ABS 400 4T 09-11, X-MAX 400 4T-4V 15-16, X-MAX ABS 400 4T-4V 14-16, X-MAX IRONMAX ABS 400 4T-4V 16-16, X-MAX MOMODESIGN 400 4T-4V 14-14, X-MAX MOMODESIGN ABS 400 4T-4V 14-14

RICAMBI

9922090	Boccola	9924650	Serie masse Ø 25x15 gr.13
9922170	Serie masse Ø 25x15 gr.16	9926840	Serie rasamenti

VARIATORI



◀ cod. **9931790**
Variotop TPR Yamaha Majesty 250 cc X-Max 250 cc

APPLICABILITÀ

Aprilia Leonardo 250 250 4T 99-04, Leonardo 250 ST 250 4T 01-01
Benelli Velvet 250 250 4T 99-03
Italjet Jupiter 250 250 4T 00-00
Malaguti Madison S 250 250 4T 99-01, Password 250 250 4T 05-06
Mbk Skyliner 250 250 4T 00-03, Skyliner 250 ABS 250 4T 03-03
Yamaha Majesty 250 250 4T 96-03, Majesty 250 ABS 250 4T 03-03, Majesty 250 DX 250 4T 98-99, X-City 250 250 4T 07-13, X-Max 250 250 4T 05-14, X-Max 250 ABS 250 4T 11-14, X-Max 250 Black 250 4T 09-09, X-Max 250 Sport 250 4T 11-12

RICAMBI

9918060	Serie Masse Ø 20X12 Gr.12
9918310	Serie Masse Ø 20X12 Gr.10
9923320	Boccola

AA00852	Tasselli Di Traino
PL04066	Piattello Porta Tasselli

NEW



◀ cod. **9932860**
Variotop TPR Kymco Xciting 400 cc

APPLICABILITÀ

Kymco Xciting 400 I 400 4T 13-13, Xciting 400 I 400 4T 15-15, Xciting 400 I ABS 400 4T 14-15

RICAMBI

9927140	Cappello porta tasselli
9927150	Tasselli di traino

9924590	SR Masse D .25x15 GR.10
9926840	Serie Rasamenti

NEW



◀ cod. **9934100**
Variotop TPR BMW C 650 Sport 2016, C 650 GT 2016

APPLICABILITÀ

BMW C 650 sport 2016, C 650 GT 2016

KIT SCARICO-VARIATORE



◀ cod. **9931500**
Kit Variotop + Exhaust System LV ONE T-MAX 530

APPLICABILITÀ

Yamaha T-Max 59C 530 530 4T 12-16, T-Max 59C 530 ABS 530 4T 12-16, T-Max 59C 530 SP 530 4T 15-15, T-Max 59C 530 SP ABS 530 4T 15-16

RICAMBI

9922130	Serie Masse Ø 25X15 Gr.14 T-Max
8588E	Marmitta SBK LV One Evo

9927130	New Variotop Tpr Yamaha T-Max (Tutti I Modelli)
---------	---



◀ cod. **9933800**
Variatore Top by J.Costa per Yamaha T-MAX 500

APPLICABILITÀ

Yamaha T-Max 4BS 500 500 4T 09-11, T-Max 4BS ABS 500 500 4T 08-11, T-Max 5VU 500 500 4T 04-08, T-Max 5VU ABS 500 500 4T 05-07, T-Max 5VU BLACK MAX 500 4T 06-06, T-Max 5VU BLACK MAX - NIGHT MAX 500 4T 07-07, T-Max SV 500 4T 11-11, T-Max SV ABS 500 4T 11-11, T-Max White Max 500 4T 10-10



◀ cod. **9933810**
Variatore Top by J.Costa per Yamaha T-MAX 530

APPLICABILITÀ

Yamaha T-Max 59C 530 530 4T 12-16, T-Max 59C 530 ABS 530 4T 12-16, T-Max 59C 530 SP 530 4T 15-15, T-Max 59C 530 SP ABS 530 4T 15-16



◀ cod. **9933820**
Variatore Top by J.Costa per Yamaha X-MAX 400

APPLICABILITÀ

Yamaha X-Max 400 4T-4V 15-16, X-Max Abs 400 4T-4V 14-16, X-Max Ironmax Abs 400 4T-4V 16-16, X-Max Momodesign 400 4T-4V 14-14, X-Max Momodesign Abs 400 4T-4V 14-14



◀ cod. **9933830**
Variatore Top by J.Costa per Honda Silver Wing 400

APPLICABILITÀ

Honda SW-T 400 [FJS] 400 4T 09-13, Silver Wing 400 [FJS] 400 4T 06-08



◀ cod. **9933840**
Variatore Top by J.Costa per Honda Silver Wing 600

APPLICABILITÀ

Honda SW-T 600 [FJS] 600 4T 11-13, Silver Wing 600 [FJS] 600 4T 01-10

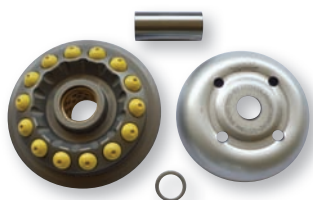

◀ cod. **9933850**
Variatore Top by J.Costa per Honda SH 300

APPLICABILITÀ

Honda SH IE 300 Scoopy 300 4T-4V 07-16

SCOOTER 50cc



◀ cod. **9907770**



Cinghia di trasmissione per motori scooter 50 cc Minarelli/Yamaha

RIFERIMENTO ORIGINALE

Aprilia	AP8206109
Benelli	R16140011A0

Yamaha	SRNE76411000
--------	--------------

APPLICABILITÀ: SCOOTER 50 CC

Aprilia	Amico 50 2T 94-94, Amico 50 2T 96-98, Amico GL/GLE 50 2T 93-95, Amico LX/Sport/Cat 50 2T 92-93, Area 51 50 2T 98-00, Gulliver 50 2T 95-98, Gulliver LC 50 2T 96-98, Rally 50 2T 95-03, Rally Liquid Cooled 50 2T 96-99, SR (Orizzontale) 50 2T 94-96, SR (Verticale) 50 2T 93-93, SR Liquid Cooled 50 2T 94-96, SR Racing 50 2T 97-99, SR Stealth 50 2T 97-99, SR WWW 50 2T 97-01, Scarabeo 50 2T 93-05
Atala	Carosello 50 2T -00
Benelli	491 GT 50 2T 98-99, 491 RR 50 2T 99-01, 491 Racing 50 2T 98-99, 491 SP 50 2T 99-99, 491 ST 50 2T 99-01, 491 Sport 50 2T 98-99, K2 50 2T 98-01, K2 Liquid Cooled 50 2T 98-01, Naked 50 2T 02-02, Pepe 50 2T 99-01, Pepe LX 50 2T 03-04
Beta	Ark 50 2T 96-08, Ark LC 50 2T 96-08, Chrono 50 2T 96-00, Eikon 50 2T 99-03, Quadra 50 2T 95-00, Tempo 50 2T 95-00
Italjet	Dragster 50 2T -00, Pista 2 50 2T -00, Scoop 2 50 2T -00, Yankee 50 2T -00
KTM	K50 50 2T -00
Macal	Thunder 50 2T -00

Malaguti	Centro 50 2T -00, Gak 50 2T -00, Gak Euro 2,2,3 50 2T 03-03, Gak Euro 2 50 2T 01-03, Gak Master Euro 2 50 2T 06-06, F12 Phantom 50 2T -00, F12 Phantom Euro 2 50 2T 02-02, F12 Phantom Euro 2,2,3 50 2T 03-04, F12 Phantom LC 50 2T -00, F12 Phantom LC Euro 2,2,3 50 2T 03-04, F12 R Phantom LC 50 2T 07-09, F12 Restyling Euro 1 50 2T 99-02, F12 Restyling Euro 2 50 2T 06-06, F12 Restyling LC Euro 2 50 2T 06-06, F15 Firefox 50 2T -00, F15 Firefox Euro 2 50 2T 02-06, F15 Firefox Euro 2,2,3 50 2T 03-04
Mbk	Booster 50 2T -00, Booster Euro 2 50 2T 04-04, Booster NG 50 2T 03-00, Booster Rocket 50 2T 97-98, Booster Spirit 50 2T 03-00, Booster Track 50 2T 96-98, Flipper 50 2T -00, Flipper Euro 2 50 2T 03-03, Mach G 50 2T 02-04, Mach G LC 50 2T 02-04, Nitro 50 2T -00, Nitro Euro 2 50 2T 03-03, Ovetto 50 2T -00, Ovetto Euro 2 50 2T 02-02, Stunt 50 2T 00-02
Motron	Syncro 50 2T -00, Thunder 50 2T -00
Rieju	First 50 2T -00, Windy 50 2T -00
Yamaha	Aerox 50 2T -00, Aerox Euro 2 50 2T 03-03, BWS 50 2T -00, BWS Bump 50 2T 97-98, BWS Euro 2 50 2T 03-03, BWS NG 50 2T -00, BWS NG Euro 2 50 2T 03-03, Jog R 50 2T 02-10, Jog R LC 50 2T -00, Neo's 50 2T -00, Neo's Euro 2 50 2T 02-02, Slider 50 2T 00-02, Spy 50 2T 95-98, Why 50 2T -00, Why Euro 2 50 2T 03-03, Zuma 50 2T 97-01

◀ cod. **9907900**



Cinghia di trasmissione per motori scooter 50 cc Minarelli/Yamaha tipo orizzontale corto

RIFERIMENTO ORIGINALE

Aprilia	AP8206818
---------	-----------

Yamaha	3WF176410000
--------	--------------

APPLICABILITÀ: SCOOTER 50 CC - ATV QUAD

Aprilia	Sonic 50 2T 98-07, Sonic GP 50 2T 98-08
Dini	Helix DL603 50 2T -00, Helix DL603 90 50 2T -00, T-Rex 50 2T -00
E-Ton	Viper RXL 50 2T -00
Laverda	Quasar 50 2T -00

Malaguti	F10 50 2T -00, F10 Euro 2 50 2T -00, F10 Euro 2,2,3 50 2T 03-04, F10 Restyling Euro 2 50 2T 06-06, Yesterday 50 2T 97-00
Mbk	Evolis 50 2T 92-95, Fizz 50 2T 94-95, Forte 50 2T 94-96
Yamaha	Axis 50 2T 95-96, Breeze 50 2T 94-95, CRZ 50 2T 91-95, Jog 50 2T -00, Zest 50 2T -00

◀ cod. **9910790**



Cinghia di trasmissione per motori scooter 50 cc Peugeot

RIFERIMENTO ORIGINALE

Peugeot	729171
---------	--------

APPLICABILITÀ

Peugeot	Buxy 50 2T -00, Buxy RS 50 2T -00, Elyseo 50 2T -00, Jet Force 50 2T -00, Ludix 50 2T -00, Speedake 50 2T -00, Speedfight 50 2T -00, Squab 50 2T -00, Trekker 50 2T -00, Vivacity 50 2T -00, X-Fight 50 2T -00
----------------	--



CINGHIE DI TRASMISSIONE

SCOOTER 50cc



◀ **cod. 9913280** 
Cinghia di trasmissione per motori scooter 50 cc Piaggio

RIFERIMENTO ORIGINALE

Benelli	R030424102000
Garelli	GA06570
Garelli	GA02165
Gilera	430728

Keeway	24107B01F000
Malaguti	59015000
Piaggio	430728

APPLICABILITÀ: SCOOTER 50 CC - ATV QUAD

Benelli	Pepe 50 2T 10-10, Pepe LX 50 2T 07-09, Pepe Old 50 2T 07-09, Pepe Old 50 2T 11-11, Quattronox 50 2T 08-11	Keeway	ATV 50 EC2 50 2T 06-06, ATV OFF ROAD 50 2T 07-07, F-Act 50 2T 07-08, Flash 50 2T 07-08, Focus 50 2T 06-06, Goccia 50 2T 09-09, Hurricane 50 2T 06-08, Matrix 50 2T 06-08, Pixel Euro 2 50 2T -00, RY8 50 2T 08-08
CPI	Aragon 50 2T 03-03, Hussar 50 2T 03-03, Oliver 50 2T 03-03, Pop Corn 50 2T 03-03	Malaguti	F10 Wap Euro 2 50 2T -00, F12 R Phantom 50 2T 07-07
Explorer	Cracker 50 2T 03-03	Piaggio	Free 50 2T 92-94, Free FL 50 2T 95-02, NRG 50 2T 94-96, NRG RST MC2 50 2T 96-98, NTT 50 2T 95-96, Vespa ET2 50 2T 97-05
Garelli	Tiesse 2T 50 2T 08-08, Vip 50 4T 06-06		
Gilera	Storm 50 2T 94-95, Typhoon 50 2T 94-97, Typhoon X 50 2T 98-99		
Hupper	Montecarlo 30 50 2T -00		

◀ **cod. 9913350** 
Cinghia di trasmissione per motori scooter 50 cc Piaggio

RIFERIMENTO ORIGINALE

Piaggio	431190
---------	--------

APPLICABILITÀ

Gilera	Easy Moving 50 2T 95-96
Piaggio	Quartz 50 2T 92-96, Sfera RST 50 2T 95-97, Zip 50 2T 95-96, Zip Bimodale 50 2T 94-97, Zip Fast Rider 50 2T 93-94, Zip Fast Rider RST 50 2T 96-97, Zip RST 50 2T 96-99, Zip Sp 50 2T 96-00

◀ **cod. 9913360** 
Cinghia di trasmissione per motori scooter 50 cc Piaggio

RIFERIMENTO ORIGINALE

Piaggio	286175
---------	--------

APPLICABILITÀ

Piaggio	Sfera 50 2T 91-93, Sfera Maquillage 2 50 2T 94-94, Zip 50 2T 92-93
----------------	--

◀ **cod. 9920440** 
Cinghia di trasmissione per motori scooter 50 cc Aprilia Ditech

RIFERIMENTO ORIGINALE

Aprilia	AP2MCA000014
---------	--------------

APPLICABILITÀ

Aprilia	Mojito Custom 50 2T 99-03, Mojito Retrò 50 2T 99-03, Sr Ditech Eu2 50 2T-le 02-03, Sr H2o Ditech 50 2T-le 00-03, Sr R Factory Motore Aprilia 50 2T-le 05-05, Scarabeo Ditech 50 2T-le 01-04	Suzuki	Katana 50 2T 97-04, Zillion 50 2T 99-99
		Sym	Symphony Euro 2 50 4T 09-09



◀ **cod. 9922030**
 Cinghia di trasmissione per motori scooter 50 cc Piaggio

RIFERIMENTO ORIGINALE

Piaggio	436864
---------	--------

APPLICABILITÀ

<p>Aprilia Mojito 50 2T -, SR R 50 2T 04-09, SR R FACTORY Carburatore 50 2T -, SR R FACTORY IE 50 2T -, SR Street Carburatore 50 2T 03-12</p> <p>Derbi Atlantis 2T 50 2T 10-10, Atlantis 2T EU2 50 2T 07-09, Atlantis O2 50 2T 02-02, Atlantis O2 Bullet 50 2T 03-05, Atlantis O2 City 50 2T 03-06, Atlantis O2 Red Bullet 50 2T 03-03, Atlantis O2 Two Chic 50 2T 05-05, GP1 50 2T 01-03, GP1 EU2 50 2T 05-05, GP1 Open EU2 50 2T 06-09, GP1 Race EU2 50 2T 05-07</p>	<p>Gilera Ice 50 2T 01-05, Runner 50 2T 97-00, Runner Pure Jet 50 2T-IE 02-07, Runner Pure Jet 50 2T-IE 10-11, Runner SP 50 2T 02-06, Stalker 50 2T 97-11, Stalker Naked 50 2T 08-08, Stalker Special Edition 50 2T 07-08, Storm Euro 2 50 2T 07-07, Typhoon XR 50 2T 00-00</p> <p>Italjet Jet Set 50 2T -00, Torpedo New 50 2T -00</p> <p>Piaggio Diesel 50 2T 01-01, Free Delivery 50 2T 00-01, NRG MC3 50 2T 01-04, NRG Power DD 50 2T 05-13, NRG Power DD Serie Speciale 50 2T -, NRG Power DT 50 2T 06-11, NRG Power DT Serie Speciale 50 2T 07-08, NRG Power Pure Jet 50 2T-IE 04-05, NRG Power PureJet 50 2T-IE 06-11, NRG PureJet 50 2T-IE 02-04, NRG PureJet 50 2T-IE 10-10, Typhoon 50 2T 01-11</p>
--	--

◀ **cod. 9922040**
 Cinghia di trasmissione per motori scooter 50 cc Piaggio

RIFERIMENTO ORIGINALE

Piaggio	82645R
---------	--------

APPLICABILITÀ

Piaggio	Vespa ET2 iniezione 50 2T 97-00, Vespa ET4 50 4T 00-05, Vespa LX 2T 50 2T 05-08, Vespa LX 2T FL 50 2T 09-10, Vespa LX 2T Touring 50 2T 10-11, Vespa LX 4T 50 4T 05-08, Vespa LX 4T 4V 50 4T 4V 09-11, Vespa LX 4T 4V Touring 50 4T 4V 10-11, Vespa LXV 2T 50 2T -, Vespa LXV 2T NAVY 50 2T 08-08, Vespa S 2T & College 50 2T 07-12, Vespa S 4T 4V & College 50 4T 4V 08-11, Zip 2T 50 2T -, Zip 4T 50 4T 00-13, Zip LC 50 2T 00-04, Zip Sp 50 2T 01-04, Zip Sp Euro 2 50 2T -, Zip 100 100 4T 06-10
----------------	---

◀ **cod. 9931580**
 Cinghia di trasmissione per motori scooter 50 cc Honda Vision

RIFERIMENTO ORIGINALE

Honda	23100GGP901
-------	-------------

APPLICABILITÀ

Honda	Vision 50 2T 88-95
--------------	--------------------

◀ **cod. 9931590**
 Cinghia di trasmissione per motori scooter 50 cc Kymco

RIFERIMENTO ORIGINALE

Kymco	00107541
-------	----------

APPLICABILITÀ

Kymco	Agility 4T Carry 50 4T 11-11, Agility 4T R12 50 4T 07-08, Agility R12 50 4T 05-05, Agility R16 50 4T 08-09, Agility R16 50 4T 12-12, Agility R16 2T 50 2T 10-10, Agility R16 2T 50 2T 12-12, Agility RS 50 4T 09-09, Agility RS Naked 50 2T 10-10, Bet & Win 50 2T 02-02, Bet & Win EU2 50 2T 03-03, Dink AC 50 2T 98-02, Dink LC 50 2T 98-02, Dink Classic EU2 50 2T 03-03, Dink Euro 2 50 4T 07-07, Like 50 2T 09-09, Like 50 4T 09-09, People 50 2T 99-04, People Euro 2 50 2T 03-03, People Euro 2 50 2T 08-08, People Euro 2 50 2T 11-11, People S 50 2T 05-08, People S 4T 50 4T 06-08, Super 8 50 2T 09-09, Super 8 4T 50 4T 07-07, Super 8 4T 50 4T 09-09, Super 9 50 2T 00-00, Super 9 EU2 50 2T 03-03, Top Boy 50 2T 97-00, Vitality 2T 50 2T 04-04, Vitality 4T 50 4T 04-04, Yup 50 2T 02-02, Yup EU2 50 2T 03-03
--------------	--

CINGHIA DI TRASMISSIONE POMPA ACQUA / MISCELATORE



◀ **cod. 9933440**
 Cinghia **Pompa Acqua/Miscelatore** Scooter Piaggio 50cc

SCOOTER 50cc



◀ **cod. 9935240** **MITSUBOSHI**
Cinghia di trasmissione per motori scooter 50 cc Honda

RIFERIMENTO ORIGINALE

Honda	23100GW2013
-------	-------------

APPLICABILITÀ

Honda HONDA BALI-SFX 50cc **Peugeot** GEO 50cc

◀ **cod. 9935270** **MITSUBOSHI**
Cinghia di trasmissione per motori scooter 50 cc Minarelli/Yamaha

RIFERIMENTO ORIGINALE

Aprilia	AP8206109
Benelli	R16140011A0

Yamaha	SRNE76411000
--------	--------------

APPLICABILITÀ: SCOOTER 50 CC

<p>Aprilia Amico 50 2T 94-94, Amico 50 2T 96-98, Amico GL/GLE 50 2T 93-95, Amico LX/Sport/Cat 50 2T 92-93, Area 51 50 2T 98-00, Gulliver 50 2T 95-98, Gulliver LC 50 2T 96-98, Rally 50 2T 95-03, Rally Liquid Cooled 50 2T 96-99, SR (Orizzontale) 50 2T 94-96, SR (Verticale) 50 2T 93-93, SR Liquid Cooled 50 2T 94-96, SR RACING 50 2T 97-99, SR Stealth 50 2T 97-99, SR WWW 50 2T 97-01, Scarabeo 50 2T 93-05</p> <p>Atala Carosello 50 2T -00</p> <p>Benelli 491 GT 50 2T 98-99, 491 RR 50 2T 99-01, 491 Racing 50 2T 98-99, 491 SP 50 2T 99-99, 491 ST 50 2T 99-01, 491 Sport 50 2T 98-99, K2 50 2T 98-01, K2 Liquid Cooled 50 2T 98-01, Naked 50 2T 02-02, Pepe 50 2T 99-01, Pepe LX 50 2T 03-04</p> <p>Beta Ark 50 2T 96-08, Ark LC 50 2T 96-08, Chrono 50 2T 96-00, Eikon 50 2T 99-03, Quadra 50 2T 95-00, Tempo 50 2T 95-00</p> <p>Italjet Dragster 50 2T -00, Pista 2 50 2T -00, Scoop 2 50 2T -00, Yankee 50 2T -00</p> <p>KTM K50 50 2T -00</p> <p>Macal Thunder 50 2T -00</p>	<p>Malaguti Centro 50 2T -00, Ciak 50 2T -00, Ciak Euro 2,2,3 50 2T 03-03, Ciak Euro 2 50 2T 01-03, Ciak Master Euro 2 50 2T 06-06, F12 Phantom 50 2T -00, F12 Phantom Euro 2 50 2T 02-02, F12 Phantom Euro 2,2,3 50 2T 03-04, F12 Phantom LC 50 2T -00, F12 Phantom LC Euro 2,2,3 50 2T 03-04, F12 R Phantom LC 50 2T 07-09, F12 Restyling Euro 1 50 2T 99-02, F12 Restyling Euro 2 50 2T 06-06, F12 Restyling LC Euro 2 50 2T 06-06, F15 Firefox 50 2T -00, F15 Firefox Euro 2 50 2T 02-06, F15 Firefox Euro 2,2,3 50 2T 03-04</p> <p>Mbk Booster 50 2T -00, Booster Euro 2 50 2T 04-04, Booster NG 50 2T 03-00, Booster Rocket 50 2T 97-98, Booster Spirit 50 2T 03-00, Booster Track 50 2T 96-98, Flipper 50 2T -00, Flipper Euro 2 50 2T 03-03, Mach G 50 2T 02-04, Mach G LC 50 2T 02-04, Nitro 50 2T -00, Nitro Euro 2 50 2T 03-03, Ovetto 50 2T -00, Ovetto Euro 2 50 2T 02-02, Stunt 50 2T 00-02</p> <p>Motron Syncro 50 2T -00, Thunder 50 2T -00</p> <p>Rieju First 50 2T -00, Windy 50 2T -00</p> <p>Yamaha Aerox 50 2T -00, Aerox Euro 2 50 2T 03-03, BWS 50 2T -00, BWS Bump 50 2T 97-98, BWS Euro 2 50 2T 03-03, BWS NG 50 2T -00, BWS NG Euro 2 50 2T 03-03, Jog R 50 2T 02-10, Jog R LC 50 2T -00, Neo's 50 2T -00, Neo's Euro 2 50 2T 02-02, Slider 50 2T 00-02, Spy 50 2T 95-98, Why 50 2T -00, Why Euro 2 50 2T 03-03, Zuma 50 2T 97-01</p>
---	--

◀ **cod. 9935340** **MITSUBOSHI**
Cinghia di trasmissione per motori scooter 50 cc Minarelli/Yamaha tipo orizzontale corto

RIFERIMENTO ORIGINALE

Aprilia	AP8206818
---------	-----------

Yamaha	3WF176410000
--------	--------------

APPLICABILITÀ: SCOOTER 50 CC - ATV QUAD

<p>Aprilia Sonic 50 2T 98-07, Sonic GP 50 2T 98-08</p> <p>Dinli Helix DL603 50 2T -00, Helix DL603 90 50 2T -00, T-Rex 50 2T -00</p> <p>E-Ton Viper RXL 50 2T -00</p> <p>Laverda Quasar 50 2T -00</p>	<p>Malaguti F10 50 2T -00, F10 Euro 2 50 2T -00, F10 Euro 2,2,3 50 2T 03-04, F10 Restyling Euro 2 50 2T 06-06, Yesterday 50 2T 97-00</p> <p>Mbk Evolis 50 2T 92-95, Fizz 50 2T 94-95, Forte 50 2T 94-96</p> <p>Yamaha Axis 50 2T 95-96, Breeze 50 2T 94-95, CRZ 50 2T 91-95, Jog 50 2T -00, Zest 50 2T -00</p>
---	---

◀ **cod. 9935370** **MITSUBOSHI**
Cinghia di trasmissione per motori scooter 50 cc Peugeot

RIFERIMENTO ORIGINALE

Peugeot	776648
---------	--------

APPLICABILITÀ

Peugeot Ludix - Kisbee - Jet - Fight 3

SCOOTER 50cc



- ◀ cod. **9935410**  **MITSUBISHI**
Cinghia di trasmissione per motori scooter 50 cc Peugeot

APPLICABILITÀ

Peugeot E-Vivacity (EC-45 km/H)

- ◀ cod. **9935420**  **MITSUBISHI**
Cinghia di trasmissione per motori scooter 50 cc Piaggio

RIFERIMENTO ORIGINALE

Piaggio	82712R
---------	--------

APPLICABILITÀ

Piaggio Liberty 50cc 2T 2004-2008 / Liberty 4T 2000-2016

- ◀ cod. **9935480**  **MITSUBISHI**
Cinghia di trasmissione per motori scooter 50 cc Piaggio

RIFERIMENTO ORIGINALE

Piaggio	842907
---------	--------

APPLICABILITÀ

Piaggio Fly 50 4st / Vespa primavera 2013-2016

- ◀ cod. **9935570**  **MITSUBISHI**
Cinghia di trasmissione per motori scooter 50 cc Peugeot

RIFERIMENTO ORIGINALE

Peugeot	729171
---------	--------

APPLICABILITÀ

Peugeot Buxy 50 2T -00, Buxy RS 50 2T -00, Elyseo 50 2T -00, Jet Force 50 2T -00, Ludix 50 2T -00, Speedake 50 2T -00, Speedfight 50 2T -00, Squab 50 2T -00, Trekker 50 2T -00, Vivacity 50 2T -00, X-Fight 50 2T -00

- ◀ cod. **9935590**  **MITSUBISHI**
Cinghia di trasmissione per motori scooter 50 cc Minarelli/Yamaha

RIFERIMENTO ORIGINALE

Yamaha	5C3-E7641-00
--------	--------------

APPLICABILITÀ

Yamaha GIGGLE 50 4T RCVS NS

- ◀ cod. **9935600**  **MITSUBISHI**
Cinghia di trasmissione per motori scooter 50 cc Minarelli/Yamaha

RIFERIMENTO ORIGINALE

Yamaha	5C3-E7641-00
--------	--------------

APPLICABILITÀ

Yamaha Neo's 50 4 tempi 2009

SCOOTER 50cc



◀ cod. **9935800** **MITSUBISHI**
Cinghia di trasmissione per motori scooter 50 cc Piaggio

RIFERIMENTO ORIGINALE

Benelli	R030424102000
Garelli	GA06570
Garelli	GA02165
Gilera	430728

Keeway	24107B01F000
Malaguti	59015000
Piaggio	430728

APPLICABILITÀ: SCOOTER 50 CC - ATV QUAD

Benelli	Pepe 50 2T 10-10, Pepe LX 50 2T 07-09, Pepe Old 50 2T 07-09, Pepe Old 50 2T 11-11, Quattrononex 50 2T 08-11	Keeway	ATV 50 EC2 50 2T 06-06, ATV OFF ROAD 50 2T 07-07, F-Act 50 2T 07-08, Flash 50 2T 07-08, Focus 50 2T 06-06, Goccia 50 2T 09-09, Hurricane 50 2T 06-08, Matrix 50 2T 06-08, Pixel Euro 2 50 2T -00, RY8 50 2T 08-08
CPI	Aragon 50 2T 03-03, Hussar 50 2T 03-03, Oliver 50 2T 03-03, Pop Corn 50 2T 03-03	Malaguti	F10 Wap Euro 2 50 2T -00, F12 R Phantom 50 2T 07-07
Explorer	Cracker 50 2T 03-03	Piaggio	Free 50 2T 92-94, Free FL 50 2T 95-02, NRG 50 2T 94-96, NRG RST MC2 50 2T 96-98, NTT 50 2T 95-96, Vespa ET2 50 2T 97-05
Garelli	Tiesse 2T 50 2T 08-08, Vip 50 4T 06-06		
Gilera	Storm 50 2T 94-95, Typhoon 50 2T 94-97, Typhoon X 50 2T 98-99		
Hupper	Montecarlo 30 50 2T -00		

◀ cod. **9935810** **MITSUBISHI**
Cinghia di trasmissione per motori scooter 50 cc Piaggio

RIFERIMENTO ORIGINALE

Piaggio	431190
---------	--------

APPLICABILITÀ

Gilera	Easy Moving 50 2T 95-96
Piaggio	Quartz 50 2T 92-96, Sfera RST 50 2T 95-97, Zip 50 2T 95-96, Zip Bimodale 50 2T 94-97, Zip Fast Rider 50 2T 93-94, Zip Fast Rider RST 50 2T 96-97, Zip RST 50 2T 96-99, Zip Sp 50 2T 96-00

◀ cod. **9935820** **MITSUBISHI**
Cinghia di trasmissione per motori scooter 50 cc Aprilia

RIFERIMENTO ORIGINALE

Aprilia	AP2MCA000014
---------	--------------

APPLICABILITÀ

Aprilia	Mojito Custom 50 2T 99-03, Mojito Retrò 50 2T 99-03, Sr Ditech Eu2 50 2T-le 02-03, Sr H2o Ditech 50 2T-le 00-03, Sr R Factory Motore Aprilia 50 2T-le 05-05, Scarabeo Ditech 50 2T-le 01-04	Suzuki	Katana 50 2T 97-04, Zillion 50 2T 99-99
		Sym	Symphony Euro 2 50 4T 09-09

◀ cod. **9935830** **MITSUBISHI**
Cinghia di trasmissione per motori scooter 50 cc Piaggio

RIFERIMENTO ORIGINALE

Piaggio	436864
---------	--------

APPLICABILITÀ

Aprilia	Mojito 50 2T -, SR R 50 2T 04-09, SR R FACTORY Carburatore 50 2T -, SR R FACTORY IE 50 2T -, SR Street Carburatore 50 2T 03-12	Gilera	Ice 50 2T 01-05, Runner 50 2T 97-00, Runner Pure Jet 50 2T-IE 02-07, Runner Pure Jet 50 2T-IE 10-11, Runner SP 50 2T 02-06, Stalker 50 2T 97-11, Stalker Naked 50 2T 08-08, Stalker Special Edition 50 2T 07-08, Storm Euro 2 50 2T 07-07, Typhoon XR 50 2T 00-00
Derbi	Atlantis 2T 50 2T 10-10, Atlantis 2T EU2 50 2T 07-09, Atlantis O2 50 2T 02-02, Atlantis O2 Bullet 50 2T 03-05, Atlantis O2 City 50 2T 03-06, Atlantis O2 Red Bullet 50 2T 03-03, Atlantis O2 Two Chic 50 2T 05-05, GP1 50 2T 01-03, GP1 EU2 50 2T 05-05, GP1 Open EU2 50 2T 06-09, GP1 Race EU2 50 2T 05-07	Italjet	Jet Set 50 2T -00, Torpedo New 50 2T -00
		Piaggio	Diesis 50 2T 01-01, Free Delivery 50 2T 00-01, NRG MC3 50 2T 01-04, NRG Power DD 50 2T 05-13, NRG Power DD Serie Speciale 50 2T -, NRG Power DT 50 2T 06-11, NRG Power DT Serie Speciale 50 2T 07-08, NRG Power Pure Jet 50 2T-IE 04-05, NRG Power PureJet 50 2T-IE 06-11, NRG PureJet 50 2T-IE 02-04, NRG PureJet 50 2T-IE 10-10, Typhoon 50 2T 01-11

◀ cod. **9935840** **MITSUBISHI**
Cinghia di trasmissione per motori scooter 50 cc Piaggio

RIFERIMENTO ORIGINALE

Piaggio	82645R
---------	--------

APPLICABILITÀ

Piaggio	Vespa ET2 iniezione 50 2T 97-00, Vespa ET4 50 4T 00-05, Vespa LX 2T 50 2T 05-08, Vespa LX 2T FL 50 2T 09-10, Vespa LX 2T Touring 50 2T 10-11, Vespa LX 4T 50 4T 05-08, Vespa LX 4T 4V 50 4T-4V 09-11, Vespa LX 4T 4V Touring 50 4T-4V 10-11, Vespa LXV 2T 50 2T -, Vespa LXV 2T NAVY 50 2T 08-08, Vespa S 2T & College 50 2T 07-12, Vespa S 4T 4V & College 50 4T-4V 08-11, Zip 2T 50 2T -, Zip 4T 50 4T 00-13, Zip LC 50 2T 00-04, Zip Sp 50 2T 01-04, Zip Sp Euro 2 50 2T -, Zip 100 100 4T 06-10
----------------	---

SCOOTER 100 cc



- ◀ cod. **9935200** **MITSUBISHI**
Cinghia di trasmissione per motori scooter 100 cc 2T Aprilia

RIFERIMENTO ORIGINALE

Aprilia	AP8510802	Yamaha	5FA176410
---------	-----------	--------	-----------

APPLICABILITÀ

Aprilia Scarabeo / Booster 100 2T

- ◀ cod. **9935210** **MITSUBISHI**
Cinghia di trasmissione per motori scooter 100 cc 4T Aprilia

RIFERIMENTO ORIGINALE

Aprilia	82646R
---------	--------

APPLICABILITÀ

Aprilia Scarabeo 100 4T

- ◀ cod. **9935440** **MITSUBISHI**
Cinghia di trasmissione per motori scooter 100 cc 4T Piaggio

RIFERIMENTO ORIGINALE

Piaggio	829484
---------	--------

APPLICABILITÀ

Piaggio Piaggio / Aprilia 100 4ST

MAXI SCOOTER



- ◀ cod. **9915220** **BANDO**
- ◀ cod. **9935660** **MITSUBISHI**
Cinghia di trasmissione per motori scooter 125/150 cc Aprilia - Rotax

RIFERIMENTO ORIGINALE

Aprilia	AP0280102	Kymco	00127985
Beta	3610750000	Malaguti	51700300

APPLICABILITÀ

Aprilia	Leonardo 125 125 4T 96-02, Leonardo ST 125 4T 03-04, Scarabeo 125 125 4T 99-03, Leonardo 150 150 4T 96-02, Scarabeo 150 150 4T 99-03	Kymco	B&W 125 125 4T 00-00, B&W 125 EU2 125 4T 03-04, Dink 125 125 4T 97-98, Dink 125 EU3 125 4T 06-07, Dink Classic 125 125 4T 02-02, Dink Classic 125 EU2 125 4T 03-03, Dink LX 125 125 4T 98-00, Grand Dink 125 125 4T 01-02, Grand Dink 125 EU2 125 4T 03-04, B&W 150 150 4T 00-00, B&W 150 EU2 150 4T 03-04, Dink 150 150 4T 97-98, Dink Classic 150 150 4T 02-02, Dink Classic 150 EU2 150 4T 03-03, Dink LX 150 150 4T 98-00, Grand Dink 150 150 4T 01-02, Grand Dink 150 EU2 150 4T 03-04
BMW	C1 125 125 4T 00-03, C1 200 200 4T 02-03	Malaguti	F18 Warrior 125 125 4T 00-02, F18 Warrior 150 150 4T 00-02
Beta	Eikon 125 125 4T 00-02, Eikon 150 150 4T 00-02		

- ◀ cod. **9915340** **BANDO**
- ◀ cod. **9935780** **MITSUBISHI**
Cinghia di trasmissione per motori scooter 180 cc Piaggio

RIFERIMENTO ORIGINALE

Piaggio	484497	Gilera	484497
---------	--------	--------	--------

APPLICABILITÀ

Gilera Runner FXR 180 180 2T 97-02

Piaggio Hexagon LXT180 180 2T 98-99

MAXI SCOOTER



◀ cod. **9915350** **BANDO**

◀ cod. **9935670** **MITSUBISHI**

Cinghia di trasmissione per motori scooter 125/150 cc Piaggio

RIFERIMENTO ORIGINALE

Piaggio	434812
---------	--------

Gilera	434812
--------	--------

APPLICABILITÀ

Aprilia SR 125 125 2T 99-01, SR 150 150 2T 99-01

Piaggio Skipper 125 LX 125 2T 98-99, Hexagon 150 150 2T 94-97, Skipper 150 LX 150 2T 98-99, Skypper 150 150 2T 94-97

Gilera Runner FX 125 125 2T 97-02, Typhoon 125 125 2T 95-98, Typhoon 125 X-XR 125 2T 99-00

◀ cod. **9915360** **BANDO**

◀ cod. **9935680** **MITSUBISHI**

Cinghia di trasmissione per motori scooter 125 cc Piaggio

RIFERIMENTO ORIGINALE

Piaggio	431258
---------	--------

APPLICABILITÀ

Piaggio Hexagon 125 125 2T 94-97, Hexagon LX 125 125 2T 98-99, Skypper 125 125 2T 94-97

◀ cod. **9915370** **BANDO**

◀ cod. **9935690** **MITSUBISHI**

Cinghia di trasmissione per motori scooter 125 cc Piaggio

RIFERIMENTO ORIGINALE

Piaggio	478547
---------	--------

APPLICABILITÀ

Piaggio Sfera 125 4T 95-97, Vespa ET4 125 125 4T 96-98

◀ cod. **9915380** **BANDO**

◀ cod. **9935700** **MITSUBISHI**

Cinghia di trasmissione per motori scooter 125/150/180 cc Minarelli/Yamaha

RIFERIMENTO ORIGINALE

Benelli	R16140631A0
Malaguti	71700900
Yamaha	SDS176410000
MBK	SDS176410000

Yamaha	5NSE76411000
Yamaha	5XME76410000
Aprilia	AP8550130
Italjet	4871702090

APPLICABILITÀ

Benelli Velvet 125 125 4T 99-01, Velvet 125 Touring 125 4T 02-03, Velvet 150 150 4T 99-01, Velvet 150 Touring 150 4T 02-03

Mbk Doodo 125 125 4T 00-00, Skyliner 125 125 4T 98-02, Skyliner E 125 125 4T 03-03, Thunder 125 125 4T 01-02, Doodo 150 150 4T 01-02, Skyliner 150 150 4T 00-02, Thunder 150 150 4T 01-02

Italjet Jupiter 125 125 4T -00, Millenium 125 125 4T -00, Jupiter 150 150 4T -00, Millenium 150 150 4T -00

Yamaha Majesty 125 125 4T 98-02, Majesty 125 E 125 4T 03-09, Maxter 125 125 4T 01-02, Teo's 125 125 4T 00-00, Majesty 150 150 4T 00-02, Maxter 150 150 4T 01-02, Teo's 150 150 4T 01-02, Majesty 180 E 180 4T 03-06

Malaguti Madison 125 125 4T 99-01, Madison R Restyling 125 125 4T 02-02, Madison R Restyling 125 EU2 125 4T 03-04, Phantom Max 125 125 4T 03-03, Madison T 150 150 4T 99-01

◀ cod. **9915410** **BANDO**

Cinghia di trasmissione per motori scooter 250 cc Honda

RIFERIMENTO ORIGINALE

Honda	23100KM1671
-------	-------------

Piaggio	495158
---------	--------

APPLICABILITÀ

Honda CN 250 Spazio/Helix 250 4T 86-99

Piaggio Hexagon GT 250 250 4T 98-00



◀ cod. **9915640** **BANDO**
Cinghia di trasmissione per motori scooter 125/150 cc Kymco

RIFERIMENTO ORIGINALE

Kymco	00127785
-------	----------

APPLICABILITÀ

Kymco Heroism 125 125 4T 95-97, Movie 125 125 4T 99-00, Vivio 125 125 4T 00-00, Heroism 150 150 4T 95-97, Vivio 150 150 4T 00-00

◀ cod. **9915790** **BANDO**
Cinghia di trasmissione per motori scooter 250 cc Suzuki

RIFERIMENTO ORIGINALE

Suzuki	27601-14F11-000
--------	-----------------

APPLICABILITÀ

Suzuki AN Burgman 250 K3/K6 250 4T 03-06, AN Burgman 250 W/K2 250 4T 98-02

◀ cod. **9915800** **BANDO**
◀ cod. **9935710** **MITSUBOSHI**
Cinghia di trasmissione per motori scooter 250 cc Yamaha

RIFERIMENTO ORIGINALE

Aprilia	AP8122639
Benelli	R16040171A0
Malaguti	91700200

Yamaha	5CG176410000
MBK	5CG176410000

APPLICABILITÀ

Aprilia Leonardo 250 250 4T 99-04, Leonardo 250 ST 250 4T 01-01, Leonardo 300 300 4T 02-04
Benelli Velvet 250 250 4T 99-03
Italjet Jupiter 250 250 4T 00-00
Malaguti Madison S 250 250 4T 99-01
Mbk Skyliner 250 250 4T 00-03, Skyliner 250 ABS 250 4T 03-03
Yamaha Majesty 250 250 4T 96-03, Majesty 250 ABS 250 4T 03-03, Majesty 250 DX 250 4T 98-99

◀ cod. **9917990** **BANDO**
◀ cod. **9935720** **MITSUBOSHI**
Cinghia di trasmissione per motori scooter 250 cc Honda

RIFERIMENTO ORIGINALE

Honda	23100KFG003
Honda	23100KTB003

Piaggio	496304
---------	--------

APPLICABILITÀ

Honda Foresight 250 [FES] 250 4T 98-99, Foresight 250 [FES] D.D. 250 4T 00-05, Forza 250 [NSS] 250 4T-2V 02-07, Jazz 250 ES Reflex [NSS] 250 4T-2V 01-04, Jazz 250 Reflex[NSS] 250 4T-2V 01-01
Piaggio X9 250 250 4T 00-01

◀ cod. **9918000** **BANDO**
Cinghia di trasmissione per motori scooter 125/150 cc Honda

RIFERIMENTO ORIGINALE

Honda	23100KFF901
-------	-------------

APPLICABILITÀ

Honda Pantheon 125 [FES] 125 2T 98-02, Pantheon 150 [FES] 150 2T 98-02

◀ cod. **9920430** **BANDO**
◀ cod. **9935730** **MITSUBOSHI**
Cinghia di trasmissione per motori scooter 400 cc Suzuki

RIFERIMENTO ORIGINALE

Suzuki	27601-15F10-000
--------	-----------------

APPLICABILITÀ

Suzuki AN Burgman 400 K3/K6 400 4T 03-06

MAXI SCOOTER



◀ **cod. 9922420**
Cinghia di trasmissione per motori scooter 250 cc Kymco

RIFERIMENTO ORIGINALE

Kymco	00127998
-------	----------

APPLICABILITÀ

Kymco B&W 250 250 4T 00-00, B&W 250 EU2 250 4T 03-03, Grand Dink 250 250 4T 01-02, Grand Dink 250 EU2 250 4T 03-04, Yup 250 250 4T 03-03

◀ **cod. 9923140**

◀ **cod. 9935770** **MITSUBISHI**
Cinghia di trasmissione per motori scooter 125/150 cc Honda

RIFERIMENTO ORIGINALE

Honda	23100KGF901
Honda	23100KGG911

Keeway	200013160000
Malaguti	65044800

APPLICABILITÀ

Honda @ [NES] 125 125 4T 00-06, Bali 125 125 4T -00, Dylan 125 [SES] 125 4T 02-04, PS I 125 [PES] 125 4T 06-10, Pantheon 125 IE [FES] 125 4T-2V 03-05, SH 125 125 4T-2V 01-04, SH IE 125 Scoopy 125 4T-2V 05-12, Silver Wing 125 [FES] 125 4T-2V 07-12, @ [NES] 150 150 4T 00-06, Bali 150 150 4T -00, Dylan 150 [SES] 150 4T 02-04, PS I 150 [PES] 150 4T 06-10, Pantheon 150 IE [FES] 150 4T-2V 03-05, SH 150 150 4T-2V 01-04, SH IE 150 Scoopy 150 4T 05-12, Silver Wing 150 [FES] 150 4T-2V 07-12

Keeway Outlook 125 125 4T 07-08, Outlook DR 125 125 4T 07-11, Silverblade 4T 125 125 4T 11-11, Outlook 150 150 4T 07-08, Outlook DR 150 150 4T 07-11

Malaguti Blog 125 125 4T 11-11, Blog 125 IE 125 4T 09-10, Centro 125 IE EU3 125 4T 08-09, Centro SL 125 125 4T 11-11, Centro SL 125 IE EU3 125 4T 09-10, Blog 160 160 4T 11-11, Blog 160 IE 160 4T 09-10, Centro 160 IE EU3 160 4T 08-09, Centro SL 160 160 4T 11-11, Centro SL 160 IE EU3 160 4T 09-10

WT Motors Atene 150 150 4T -00

◀ **cod. 9925280** **MITSUBISHI**
Cinghia di trasmissione per motori scooter 125 cc Minarelli/Yamaha

RIFERIMENTO ORIGINALE

Yamaha	1B9E76410000
--------	--------------

MBK	1B9E76410000
-----	--------------

APPLICABILITÀ

Mbk Cityliner 125 EU3 125 4T-4V 08-10, Skycruiser 125 125 4T-4V 07-07

Yamaha X-City 125 EU3 125 4T-4V 08-11, X-Max R 125 125 4T-4V 06-16, X-Max R 125 ABS 125 4T-4V 11-11, X-Max RA 125 ABS 125 4T-4V 13-16

◀ **cod. 9925600** **MITSUBISHI**
Cinghia di trasmissione per motori scooter 250/300 cc Minarelli/Yamaha

RIFERIMENTO ORIGINALE

Malaguti	71701100
Yamaha	5SEE76410200

Malaguti	71701100
----------	----------

APPLICABILITÀ

Malaguti Password 250 250 4T 05-06, Password 250 EU3 250 4T 07-08

Yamaha X-City 250 250 4T 07-12, X-Max 250 250 4T 05-12, Versy 300 300 4T 03-06

Mbk Kilibre 300 300 4T 03-06

◀ **cod. 9925850** **BANDO**

◀ **cod. 9935790** **MITSUBISHI**
Cinghia di trasmissione per motori scooter 125/250 cc Sym

RIFERIMENTO ORIGINALE

Sym	1B01HMA01
-----	-----------

APPLICABILITÀ

Sym GTS Joymax 125 125 4T 06-07, GTS 250 250 4T-4V 07-08, JoyMax 250 250 4T-4V 05-07, JoyMax EU3 I 250 250 4T-4V 07-08





◀ cod. **9925860** **BANDO**
Cinghia di trasmissione per motori scooter 200 cc Sym

RIFERIMENTO ORIGINALE

Sym	1B01HHA01
-----	-----------

APPLICABILITÀ

Sym Hd Eu2 200 200 4T-4V 03-04, Hd Eu3 I 200 200 4T-4V 07-07, Hd Evo Eu2 200 200 4T-4V 05-06, Hd Evo Eu3 I 200 200 4T-4V 07-07, Hd Evo I Eu3 200 4T-4V 10-10, Hd Evo I Tamburo Eu3 200 200 4T-4V 08-09, Hd2 I 200 200 4T-4V 11-11

◀ cod. **9926420** **BANDO**
Cinghia di trasmissione per motori scooter 125/200 cc Kymco

RIFERIMENTO ORIGINALE

Kymco	00127099	Sym	1B01KN701
-------	----------	-----	-----------

APPLICABILITÀ

Kymco Dink 200 IE EU3 200 4T 06-07
Sym Fiddle II 125 125 4T 08-09, Symply 125 125 4T 07-08, Symply II 125 125 4T 09-10



◀ cod. **9926430** **BANDO**
◀ cod. **9935740** **MITSUBOSHI**
Cinghia di trasmissione per motori scooter 125/150/200 cc Kymco

RIFERIMENTO ORIGINALE

Kymco	00127541	Malaguti	51700600
Kymco	00127542	Malaguti	51700700

APPLICABILITÀ

Kymco Agility 125 125 4T 06-06, Agility 125 EU3 125 4T 06-08, Agility 125 R16 125 4T 08-09, Agility 125 RS 125 4T 09-09, Like 125 125 4T 09-09, Movie 125 EU3 125 4T 06-07, Movie XL 125 125 4T 01-01, Movie XL 125 EU2 125 4T 03-04, People 125 125 4T 99-00, People 125 EU2 125 4T 03-03, People 125 EU3 125 4T 07-08, People EU3 125 4T 11-11, People S 125 125 4T 05-05, People S DD EU3 125 125 4T 07-08, Super 8 125 125 4T 08-09, Agility 150 R16 150 4T 08-09, Movie 150 EU3 150 4T 06-07, Movie XL 150 150 4T 01-01, Movie XL 150 EU2 150 4T 03-04, People 150 150 4T 99-00, People 150 EU2 150 4T 03-03, Agility 200I R16 200 4T 10-10, Agility R16 200 4T 12-12, Like 200 IE 200 4T 09-09, Like LX 200 4T 12-12, People S 200 200 4T 05-05, People S 200 I 200 4T 07-07

Malaguti Ciak 125 125 4T 00-01, Ciak Master EU3 125 125 4T 06-06, Ciak Master 125 125 4T 04-04, Ciak Restyking EU2 125 125 4T 03-03, Ciak 150 150 4T 00-02, Ciak Master 150 150 4T 04-04, Ciak Restyking EU2 150 150 4T 03-03, Ciak Master 200 EU2 200 4T 06-06

◀ cod. **9927480** **MITSUBOSHI**
Cinghia di trasmissione per motori scooter 300 cc Honda

RIFERIMENTO ORIGINALE

Honda	23100KTW901
-------	-------------

APPLICABILITÀ

Honda SH IE 300 Scoopy 300 4T-4V 07-16

◀ cod. **9927490** **MITSUBOSHI**
Cinghia di trasmissione per motori scooter 400 cc Honda

RIFERIMENTO ORIGINALE

Honda	23100MEF003
-------	-------------

APPLICABILITÀ

Honda SW-T 400 [FJS] 400 4T 09-13, Silver Wing 400 [FJS] 400 4T 06-08

◀ cod. **9927500** **MITSUBOSHI**
Cinghia di trasmissione per motori scooter 125/150 cc Suzuki

RIFERIMENTO ORIGINALE

Suzuki	27601-21F11-000
--------	-----------------

APPLICABILITÀ

Suzuki Epicuro 125 125 4T 99-01, UH Burgman 125 K2/K6 125 4T 02-06, Epicuro 150 150 4T 99-01, UH Burgman 150 K2/K6 150 4T 02-06

MAXI SCOOTER



- ◀ cod. **9927510** **MITSUBISHI**
Cinghia di trasmissione per motori scooter 125 cc Suzuki

RIFERIMENTO ORIGINALE

Suzuki	27601-03H00-000
--------	-----------------

APPLICABILITÀ

Suzuki UH Burgman 125 K7/LO 125 4T 07-10, UH Burgman 125 L1 125 4T 11-11

- ◀ cod. **9927520** **MITSUBISHI**
Cinghia di trasmissione per motori scooter 200 cc Suzuki

RIFERIMENTO ORIGINALE

Suzuki	27601-14F30-000
--------	-----------------

APPLICABILITÀ

Suzuki UH Burgman 200 K7/LO 200 4T 07-10, UH Burgman 200 L1 200 4T 11-11

- ◀ cod. **9927530** **MITSUBISHI**
Cinghia di trasmissione per motori scooter 400 cc Yamaha

RIFERIMENTO ORIGINALE

Yamaha	SRU176410000
--------	--------------

APPLICABILITÀ

Yamaha Majesty 400 400 4T 04-06

- ◀ cod. **9927550** **MITSUBISHI**
Cinghia di trasmissione per motori scooter 500 cc Minarelli/Yamaha

RIFERIMENTO ORIGINALE

Yamaha	5VU176410000
--------	--------------

APPLICABILITÀ

Yamaha T-Max 4BS 500 500 4T 09-11, T-Max 4BS ABS 500 500 4T 08-11, T-Max 5GJ 500 500 4T 01-03, T-Max 5VU 500 500 4T 04-08, T-Max 5VU ABS 500 500 4T 05-07, T-Max 5VU BLACK MAX 500 4T 06-06, T-Max 5VU BLACK MAX - NIGHT MAX 500 4T 07-07

- ◀ cod. **9927630** **MITSUBISHI**
Cinghia di trasmissione per motori scooter 400/500 cc Piaggio

RIFERIMENTO ORIGINALE

Piaggio	832738
Piaggio	849090

Malaguti	41701600
----------	----------

APPLICABILITÀ

Aprilia Atlantic Arrecife 400 400 4T -00, Atlantic Sprint 400 400 4T 05-08, Scarabeo Light 400 400 4T 06-08, Atlantic 500 500 4T 01-04, Atlantic Arrecife 500 500 4T 05-08, Atlantic Sprint 500 500 4T 05-08, Scarabeo 500 500 4T 03-06, Scarabeo Light 500 500 4T 06-08

Gilera Fuoco 500 IE EU3 500 4T 07-13, Nexus 500 500 4T 03-05, Nexus 500 EU3 500 4T 06-11, Nexus SP 500 EU3 500 4T 06-07

Malaguti Spider Max 500 GT 500 4T 04-05, Spider Max 500 GT EU3 500 4T 06-06, Spider Max RS 500 500 4T 08-08

Peugeot Geopolis 400 IE EU3 400 4T-4V -00, Satelis 400 EU3 400 4T -00, Geopolis 500 IE EU3 500 4T-4V -00, Satelis 500 EU3 500 4T -00

Piaggio Beverly 400 EU3 400 4T 06-07, Beverly Tourer 400 EU3 400 4T 08-10, MP3 400 400 4T 07-08, MP3 400 IE LT Touring 400 4T 11-11, MP3 400 IE LT/Sport 400 4T 08-10, MP3 400 MIC 400 4T 08-10, MP3 400 RL Touring 400 4T 11-11, X-Evo 400 400 4T 07-11, X8 400 EU3 400 4T 06-08, Beverly 500 500 4T 02-06, Beverly 500 IE EU3 500 4T 06-08, X9 Evolution 500 500 4T 03-07, X9 Evolution ABS 500 500 4T 06-07

- ◀ cod. **9927640** **MITSUBISHI**
Cinghia di trasmissione per motori scooter Piaggio Beverly 250 cc

RIFERIMENTO ORIGINALE

Piaggio	B013360
Aprilia	B013360

Derbi	B013360
-------	---------

APPLICABILITÀ

Aprilia Scarabeo 250 250 4T 04-06, Scarabeo Light 250 250 4T 06-08, Sportcity 250 250 4T -00, Sportcity 250 EU3 250 4T 06-08, Sportcity Cube 250 250 4T 08-12, Scarabeo Light 300 300 4T 09-10, Sportcity Cube 300 300 4T 08-10, Sprot City Street 300 300 4T-4V 12-12

Derbi Rambla 250 250 4T 08-09, Rambla 250 EU3 2VER 250 4T 08-08, Rambla 300 300 4T 10-11

Piaggio Beverly 250 250 4T 06-07, Beverly 250 CRUISER 250 4T 07-09, Beverly 250 EURO 3 MIC 250 4T 07-07, Beverly 250 SPORT 250 4T 06-08, Beverly 250 Tourer EU3 250 4T 07-09, Beverly 250 IE EU3 250 4T 06-08, Beverly RST 250 250 4T 04-05, Carnaby 250 250 4T 08-08, Beverly 300 RST 4T 4V IE EU3 300 4T 10-15, Beverly Tourer 300 EU3 300 4T 09-10, Carnaby Cruiser 300 300 4T 09-12



◀ cod. **9927650** **MITSUBISHI**
Cinghia di trasmissione per motori scooter 125/150 cc Piaggio

RIFERIMENTO ORIGINALE

Piaggio	841213
Benelli	R13440941A0
Aprilia	841213

Derbi	841213
Gilera	841213

APPLICABILITÀ

Aprilia Atlantic 125 125 4T 03-05, Atlantic 125 EU3 125 4T 06-08, Atlantic 125 EU3 125 4T 10-12, Atlantic Arrecife 125 125 4T -00, Mojito 125 125 4T 03-08, SR MAX 125 125 4T 11-14, SR Motard 125 125 4T 2V 12-12, Sportcity One 4T EU3 125 125 4T 08-11, Mojito 150 150 4T 03-07

Benelli Adiva 125 125 4T 01-02, Adiva 150 150 4T 01-02

Derbi Boulevard 125 125 4T 02-04, Boulevard 125 EU3 125 4T 04-07, Boulevard 4T EU3 125 4T 08-12, GP1 125 EU 2 125 4T 06-06, GP1 Low Seat EU3 125 4T 07-08, Sonar 4T 125 125 4T 09-11, Variant Sport 4T EU3 125 4T 12-12, Boulevard 150 150 4T 02-04, Boulevard 150 EU3 150 4T 04-07, Boulevard 4T E3 150 4T 10-10, Sonar 4T 150 150 4T 09-09

Gilera DNA 125 125 4T 01-01, Nexus 125 EU3 125 4T 07-08, Nexus 125 IE EU3 125 4T 08-10, Runner 4T ST EU3 125 125 4T 08-13, Runner VX 125 125 4T 00-06, Runner VX 4T EU3 125 125 4T 06-07, Runner VX Race 125 125 4T 06-06, Runner VX SC 125 4T 06-07

Piaggio Fly 125 125 4T 05-07, Fly 125 EU3 125 4T 07-11, Hexagon GTX 125 125 4T 00-00, Liberty 125 125 4T 01-02, Liberty 125 4T 125 4T 06-07, Liberty 125 4T EU3 125 4T 07-08, Liberty 125 4T EU3 Delivery - TNT 125 4T 08-15, Liberty 125 4T Sport EU3 125 4T 06-08, Liberty 125 Sport 125 4T 06-06, Liberty 4T 2V Euro3 125 4T 09-12, Liberty RST 125 125 4T 04-05, Liberty RST PTT 125 125 4T 05-11, MP3 125 125 4T 06-08, MP3 125 IE 125 4T 08-09, MP3 125 IE Touring 125 4T 11-12, MP3 125 Ibrido 125 4T 09-10, MP3 125 Yourban ERL 125 4T 11-11, Skyyper 125 4T 125 4T 00-02, Super Hexagon GTX 12 125 125 4T 01-02, Typhoon 125 4T 2V E3 125 4T 10-11, Vespa ET4 125 125 4T 99-02,

Vespa GRANTURISMO 125 125 4T 03-07, Vespa GRANTURISMO 125 EU3 125 4T 06-07, Vespa GTS 125 EU3 125 4T 07-12, Vespa GTS 4T IE SUPER 125 4T 09-16, Vespa GTV 125 125 4T 06-08, Vespa GTV 4T NAVY EU3 125 125 4T 08-08, Vespa LX 125 125 4T 05-06, Vespa LX 4T EU3 TOURING 125 4T 10-11, Vespa LX 4T FL 125 4T 09-09, Vespa LX EU3 125 4T 06-08, Vespa LX EU3 IE 125 4T 09-10, Vespa LXV 4T EU3 125 4T 06-09, Vespa LXV IE 4T 125 4T 10-12, Vespa LXV NAVY EU3 125 4T 07-08, Vespa S 4T 125 EU3 125 4T 07-08, Vespa S 4T IE & COLLEGE 125 4T 09-11, X-Evo 125 125 4T 07-16, X7 125 EU3 125 4T 08-08, X7 Evo 125 IE EU3 125 4T 09-10, X8 125 125 4T 04-06, X8 125 Premium EU2 125 4T 06-06, X8 125 Premium EU3 125 4T 06-07, X8 Street 125 EU2 125 4T 06-07, X9 125 125 4T 01-02, X9 Evolution 125 125 4T 03-03, X9 Evolution 125 125 4T 05-06, X9 Evolution EU3 125 125 4T 07-07, Zip 125 125 4T 00-02, Fly 150 150 4T 05-07, Fly 150 EU3 150 4T 08-11, Liberty 150 150 4T 01-02, Liberty 150 4T EU3 150 4T 08-08, Liberty 150 4T Sport EU3 150 4T 08-08, Liberty 150 Moc 4T 150 4T 09-13, Skyyper 150 4T 150 4T 00-02, Vespa ET4 150 150 4T 99-02, Vespa LX 150 150 4T 05-06, Vespa LX 4T FL 150 4T 09-09, Vespa LX EU3 150 4T 06-08, Vespa LX EU3 IE 150 4T 09-11, Vespa LX TOURING 150 4T 10-12, Vespa S 4T 150 150 4T 08-09, Vespa S 4T IE & COLLEGE 150 4T 09-11, X8 Street 150 EU2 150 4T 06-08

Renault Fulltime 125 125 4T -00

◀ cod. **9927660** **MITSUBISHI**
Cinghia di trasmissione per motori scooter 400 cc Suzuki

RIFERIMENTO ORIGINALE

Suzuki	27601-05H00-000
--------	-----------------

APPLICABILITÀ

Suzuki AN Burgman 400 K7/L0 400 4T 07-10, AN Burgman 400 L1 400 4T 11-11

◀ cod. **9928540** **MITSUBISHI**
Cinghia di trasmissione per motori scooter 125/250 cc Piaggio

RIFERIMENTO ORIGINALE

Piaggio	842009
Aprilia	842009

Derbi	842009
-------	--------

APPLICABILITÀ

Aprilia Scarabeo 125 125 4T 03-06, Scarabeo EU3 125 125 4T 06-07, Sport City Street 125 125 4T 12-12, Sportcity 125 125 4T 04-06, Sportcity 125 EU3 125 4T 06-08, Sportcity Cube 125 125 4T 08-10, Scarabeo 150 150 4T 04-06

Derbi Rambla 125 125 4T 08-09

Piaggio Beverly 125 125 4T 01-03, Beverly 125 EU3 125 4T 07-08, Beverly 125 EURO 3 MIC 125 4T 07-07, Beverly 125 EURO 3 SPORT 125 4T 07-08, Beverly 125 RST 4T 4V IE EU3 125 4T 10-15, Beverly 125 Tourer EU3 125 4T 07-10, Beverly RST 125 125 4T 04-07, Carnaby 125 125 4T 07-10

WT Motors Miami 250 250 4T -00

MAXI SCOOTER



- ◀ cod. **9929770** **MITSUBOSHI**
Cinghia di trasmissione per motori scooter 300 cc Kymco

RIFERIMENTO ORIGINALE

Kymco	00123195
-------	----------

APPLICABILITÀ

Kymco Xciting 300 I 300 4T 08-08, Xciting R 300i 300 4T 08-09



- ◀ cod. **9931550** **BANDO**
Cinghia di trasmissione per motori scooter 125 cc Yamaha

RIFERIMENTO ORIGINALE

Yamaha	4CW176410200
--------	--------------

APPLICABILITÀ

Mbk Flame F 125 125 4T 00-00, Flame R 125 125 4T 96-99, **Yamaha** Cygnus R 125 (XCX) 125 4T 97-98, Cygnus R 125 (XC) 125 4T 99-03, Cygnus 125 (XCT) 125 4T 95-98

- ◀ cod. **9931560** **BANDO**

- ◀ cod. **9935750** **MITSUBOSHI**
Cinghia di trasmissione per motori scooter 125 cc Yamaha

RIFERIMENTO ORIGINALE

Yamaha	5ML176410000
--------	--------------

APPLICABILITÀ

Yamaha Cygnus X 125 (NXC) 125 4T 04-06, Cygnus X 125 ie EU3 (NXC) 125 4T 07-11

- ◀ cod. **9931610**

- ◀ cod. **9935760** **MITSUBOSHI**
Cinghia di trasmissione per motori scooter 150 cc Yamaha

RIFERIMENTO ORIGINALE

Yamaha	525E76410000
--------	--------------

APPLICABILITÀ

Yamaha Xenter 125/150 cc

- ◀ cod. **9931680** **BANDO**
Cinghia di trasmissione per motori scooter 150 cc Sym

RIFERIMENTO ORIGINALE

Sym	1B01ARA01
-----	-----------

APPLICABILITÀ

Sym Symphony 125 125 4T 09-09, Symphony S 125 125 4T 09-10, Symphony S 125 125 4T 12-14, Symphony SR 125 125 4T 10-10, Symphony SR 125 125 4T 12-12, Symphony 150 150 4T 09-09, Symphony S 150 150 4T 10-10, Symphony S 150 150 4T 12-14, Symphony SR 150 150 4T 10-10, Symphony SR 150 150 4T 12-12

- ◀ cod. **9935220** **MITSUBOSHI**
Cinghia di trasmissione per motori scooter 125/200 cc Aprilia

RIFERIMENTO ORIGINALE

Aprilia	856026
---------	--------

APPLICABILITÀ

Aprilia Scarabeo light 125/200 RCVS N5

- ◀ cod. **9935230** **MITSUBOSHI**
Cinghia di trasmissione per motori scooter 600cc BMW

RIFERIMENTO ORIGINALE

BMW	24827729767
-----	-------------

APPLICABILITÀ

Bmw 600 C Sport, 650 C GT (2011-2016)



- ◀ cod. **9935250**  **MITSUBISHI**
Cinghia di trasmissione per motori scooter 600cc Honda

RIFERIMENTO ORIGINALE

Honda	23100MCT003
-------	-------------

APPLICABILITÀ

Kymco Silver Wing 600

- ◀ cod. **9935260**  **MITSUBISHI**
Cinghia di trasmissione per motori scooter 125/150 cc Keeway

RIFERIMENTO ORIGINALE

Keeway	24160-J05-F000
--------	----------------

APPLICABILITÀ

Keeway Matrix 125/150

- ◀ cod. **9935280**  **MITSUBISHI**
Cinghia di trasmissione per motori scooter 250 cc Kymco

RIFERIMENTO ORIGINALE

Kymco	23100-LLJ3-E00 (00127543)
-------	---------------------------

APPLICABILITÀ

Kymco People 250 / Xciting 250

- ◀ cod. **9935290**  **MITSUBISHI**
Cinghia di trasmissione per motori scooter 500cc Kymco

RIFERIMENTO ORIGINALE

Kymco	23100-LBA2-E001 (00127038)
-------	----------------------------

APPLICABILITÀ

Kymco Xciting 500

- ◀ cod. **9935300**  **MITSUBISHI**
Cinghia di trasmissione per motori scooter 250 cc Kymco

RIFERIMENTO ORIGINALE

Kymco	23100-LDF2-9000 (00127086)
-------	----------------------------

APPLICABILITÀ

Kymco Xciting 250 ie RCVS NS (2006/2007)

- ◀ cod. **9935310**  **MITSUBISHI**
Cinghia di trasmissione per motori scooter 125 cc Kymco

RIFERIMENTO ORIGINALE

Kymco	23100-LFA7-EOA (00123267)
-------	---------------------------

APPLICABILITÀ

Kymco 125 Down Town ie (09)

- ◀ cod. **9935320**  **MITSUBISHI**
Cinghia di trasmissione per motori scooter 300cc Kymco

RIFERIMENTO ORIGINALE

Kymco	23100LEA7 E00 (00123257)
-------	--------------------------

APPLICABILITÀ

Kymco 300 Down Town ie (09)

MAXI SCOOTER



◀ cod. **9935330**  **MITSUBOSHI**
Cinghia di trasmissione per motori scooter 200 cc Kymco

RIFERIMENTO ORIGINALE

Kymco	23100-LGF9-E0B (00123279)
-------	---------------------------

APPLICABILITÀ

Kymco Down Town 200 cc, People GT 250 cc 10-14

◀ cod. **9935350**  **MITSUBOSHI**
Cinghia di trasmissione per motori scooter 125 cc Peugeot

RIFERIMENTO ORIGINALE

Peugeot	771534
---------	--------

APPLICABILITÀ

Peugeot Satelis 125

◀ cod. **9935360**  **MITSUBOSHI**
Cinghia di trasmissione per motori scooter 400 cc Peugeot

RIFERIMENTO ORIGINALE

Peugeot	781317
---------	--------

APPLICABILITÀ

Peugeot Metropolis 400

◀ cod. **9935380**  **MITSUBOSHI**
Cinghia di trasmissione per motori scooter 125 cc Peugeot

RIFERIMENTO ORIGINALE

Peugeot	775218
---------	--------

APPLICABILITÀ

Peugeot Geopolis/Executive ie, Geopolis RS/Premium/E ie, Satelis

◀ cod. **9935390**  **MITSUBOSHI**
Cinghia di trasmissione per motori scooter 125 cc Peugeot

RIFERIMENTO ORIGINALE

Peugeot	772816
---------	--------

APPLICABILITÀ

Peugeot Satelis Kompressor

◀ cod. **9935400**  **MITSUBOSHI**
Cinghia di trasmissione per motori scooter 400 cc Peugeot

RIFERIMENTO ORIGINALE

Peugeot	786232
---------	--------

APPLICABILITÀ

Peugeot Metropolis (New) 400



◀ cod. **9935430**  **MITSUBISHI**
Cinghia di trasmissione per motori scooter 125 cc Piaggio

RIFERIMENTO ORIGINALE

Piaggio	825059
---------	--------

APPLICABILITÀ

Piaggio Liberty, Hexagon 125cc 4str

◀ cod. **9935450**  **MITSUBISHI**
Cinghia di trasmissione per motori scooter 200 cc Piaggio

RIFERIMENTO ORIGINALE

Piaggio	842011
---------	--------

APPLICABILITÀ

Piaggio Beverly 200 cc 01-03, Carnaby 200 cc 07-08

◀ cod. **9935460**  **MITSUBISHI**
Cinghia di trasmissione per motori scooter 500cc Piaggio

RIFERIMENTO ORIGINALE

Piaggio	827826
---------	--------

APPLICABILITÀ

Piaggio X9 500cc 2001-2002

◀ cod. **9935470**  **MITSUBISHI**
Cinghia di trasmissione per motori scooter 250 cc Piaggio

RIFERIMENTO ORIGINALE

Piaggio	82941R
---------	--------

APPLICABILITÀ

Piaggio X9 250cc short W/B

◀ cod. **9935490**  **MITSUBISHI**
Cinghia di trasmissione per motori scooter 350cc Piaggio

RIFERIMENTO ORIGINALE

Piaggio	83025R
---------	--------

APPLICABILITÀ

Piaggio Beverly Sport Touring 350 cc, X10 4T-4V

◀ cod. **9935500**  **MITSUBISHI**
Cinghia di trasmissione per motori scooter 500cc Piaggio

RIFERIMENTO ORIGINALE

Piaggio	849090
---------	--------

APPLICABILITÀ

Piaggio X10 500 cc 12-14, MP3 500 cc 11-16

MAXI SCOOTER



- ◀ **cod. 9935510**  **MITSUBOSHI**
Cinghia di trasmissione per motori scooter 250 cc Suzuki

RIFERIMENTO ORIGINALE

Suzuki	27601-14F01-000
--------	-----------------

APPLICABILITÀ

Suzuki Burgman 250W-K2

- ◀ **cod. 9935520**  **MITSUBOSHI**
Cinghia di trasmissione per motori scooter 400 cc Suzuki

RIFERIMENTO ORIGINALE

Suzuki	27601-15F03-000
--------	-----------------

APPLICABILITÀ

Suzuki Burgman 400 X-K2

- ◀ **cod. 9935530**  **MITSUBOSHI**
Cinghia di trasmissione per motori scooter 125cc Suzuki

RIFERIMENTO ORIGINALE

Suzuki	27601-20H00-000
--------	-----------------

APPLICABILITÀ

Suzuki Ux 125 sixteen K8-L1

- ◀ **cod. 9935540**  **MITSUBOSHI**
Cinghia di trasmissione per motori scooter 150 cc Suzuki

RIFERIMENTO ORIGINALE

Suzuki	27601-20H60-000
--------	-----------------

APPLICABILITÀ

Suzuki Ux 150 Sixteen K8-L1

- ◀ **cod. 9935550**  **MITSUBOSHI**
Cinghia di trasmissione per motori scooter 300cc Sym

RIFERIMENTO ORIGINALE

Sym	1B01LEA01 (23100-LEA-000)
-----	---------------------------

APPLICABILITÀ

Sym Citycom 300 / 2008

- ◀ **cod. 9935560**  **MITSUBOSHI**
Cinghia di trasmissione per motori scooter 300cc Sym

RIFERIMENTO ORIGINALE

Sym	1B01HWA01
-----	-----------

APPLICABILITÀ

Sym 300 GTS Joymax EVO (09) EVO ie (10)



◀ cod. **9935580**  **MITSUBOSHI**
Cinghia di trasmissione per motori scooter 400 cc Yamaha

RIFERIMENTO ORIGINALE

Yamaha	5RU176411000
--------	--------------

APPLICABILITÀ

Yamaha Majesty 400 2007/2008

◀ cod. **9935610**  **MITSUBOSHI**
Cinghia di trasmissione per motori scooter 400 cc Yamaha

RIFERIMENTO ORIGINALE

Yamaha	34B176410000
--------	--------------

APPLICABILITÀ

Yamaha YP Majesty 400cc (09)

◀ cod. **9935620**  **MITSUBOSHI**
Cinghia di trasmissione per motori scooter 125cc 4T Yamaha

RIFERIMENTO ORIGINALE

Yamaha	5NWE76410000
--------	--------------

APPLICABILITÀ

Yamaha Vity 125cc 2008/2012

◀ cod. **9935630**  **MITSUBOSHI**
Cinghia di trasmissione per motori scooter 125cc 4T Yamaha

RIFERIMENTO ORIGINALE

Yamaha	5S9E76410000
--------	--------------

APPLICABILITÀ

Yamaha BW'S 125

◀ cod. **9935640**  **MITSUBOSHI**
Cinghia di trasmissione per motori scooter 125cc 4T Yamaha

RIFERIMENTO ORIGINALE

Yamaha	5NWE76410000
--------	--------------

APPLICABILITÀ

Yamaha 125 Vity

◀ cod. **9935650**  **MITSUBOSHI**
Cinghia di trasmissione per motori scooter 400 cc Minarelli/Yamaha

RIFERIMENTO ORIGINALE

Yamaha	1SDE76410000
--------	--------------

APPLICABILITÀ

Yamaha X-Max 400

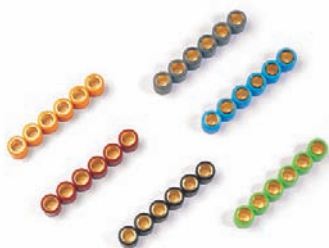

◀ Serie 6 masse variatore ø 15x12

APPLICABILITÀ

Aprilia - Atala - Benelli - Beta - Italjet - KTM - Macal - Malaguti - MBK - Motron - Rieju - Yamaha applicabili a tutti i variatori Top Performances

Codice	Colore	Peso
9912900	ROSSO	4
9912920	VERDE	4,5
9912910	GIALLO	5

Codice	Colore	Peso
9906140	GRIGIO	5,5
9912940	NERO	6
9915570	NERO	7,5

Codice	Colore	Peso
9927160	NERA	3,8
9912930	AZZURRO	6,5
9925610	ROSSO	6,9

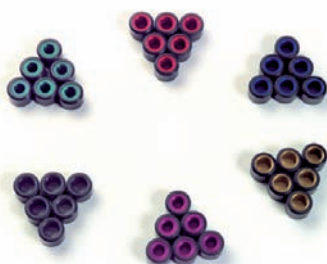

◀ Serie 6 masse variatore ø 15x12 in alluminio

APPLICABILITÀ

Aprilia - Atala - Benelli - Beta - Italjet - KTM - Macal - Malaguti - MBK - Motron - Rieju - Yamaha applicabili a tutti i variatori Top Performances

Codice	Colore	Peso
9912870	FUME	2,5
9912840	ORO	2,8

Codice	Colore	Peso
9912880	BLU	3
9912850	ROSSO	3,3

Codice	Colore	Peso
9912890	VIOLA	3,5
9912860	VERDE	3,8



◀ Serie 6 masse variatore ø 16x13 per variatori originali

APPLICABILITÀ

BSV - Gilera - Honda - HSC - Peugeot - Piaggio

Codice	Colore	Peso
9920030	NERO	4,2
9920040	NERO	4,6
9920050	NERO	5
9914390	ARANCIONE	5,5
9914380	ROSSO	6

Codice	Colore	Peso
9914400	BIANCO	6,5
9914370	VERDE	7
9914410	BLU	7,5
9914360	GIALLO	8
9915400	NERO	8,5

Codice	Colore	Peso
9920060	NERO	8,8
9920070	NERO	9,2
9920080	NERO	9,5
9920090	NERO	9,7
9920100	NERO	10,2



◀ Serie 6 masse variatore ø 16x13 in alluminio

APPLICABILITÀ

BSV - Gilera - Honda - HSC - Peugeot - Piaggio

Codice	Colore	Peso
9911960	ORO	3
9911990	GRIGIO	3,3

Codice	Colore	Peso
9911980	BLU	3,8
9911970	VIOLA	4,2

Codice	Colore	Peso
9911950	VERDE	4,6
9911940	ROSSO	5



◀ Serie 6 masse variatore ø 17x12,5

APPLICABILITÀ

Suzuki - Morini - Italjet - Malaguti - Aprilia SR

Codice	Colore	Peso
9919870	NERO	4
9919880	NERO	4,5
9919890	NERO	5
9919900	NERO	5,5

Codice	Colore	Peso
9915190	NERO	5,9
9919910	NERO	6
9919920	NERO	6,5
9915200	NERO	6,8

Codice	Colore	Peso
9919930	NERO	7
9920540	NERO	7,5
9915210	NERO	11,3



◀ Serie 6 masse variatore ø 18x13,8

APPLICABILITÀ

Kymco People

Codice	Colore	Peso	Codice	Colore	Peso
9917640	NEUTRA	13	9917660	NEUTRA	12

◀ Serie 6 masse variatore ø 19x13,8

APPLICABILITÀ

Piaggio Liberty 125 cc

Codice	Colore	Peso	Codice	Colore	Peso	Codice	Colore	Peso
9922810	ROSSO	10	9922830	VERDE	11	9922850	BIANCO	12

◀ Serie 6 masse variatore ø 19x15,5

APPLICABILITÀ

Derbi - Gilera - Piaggio

Codice	Colore	Peso	Codice	Colore	Peso	Codice	Colore	Peso
9919940	NERO	4,8	9919970	NERO	6	9922890	NERO	7,5
9919950	NERO	5,2	9919980	NERO	6,5	9920000	NERO	8
9919960	NERO	5,6	9919990	NERO	7	9920010	NERO	9

◀ Serie 6 masse variatore ø 19x17

APPLICABILITÀ

Gilera - Piaggio

Codice	Colore	Peso	Codice	Colore	Peso	Codice	Colore	Peso
9922710	ROSSO	5,4	9922790	GIALLO	7,7	9916400	VERDE	10
9922730	VERDE	6,1	9916340	BIANCO	8,5	9916420	NERO	11
9922750	BIANCO	6,6	9916360	ROSSO	9	9915290	GRIGIO	13
9922770	BLU	7,3	9916380	GIALLO	9,5			

◀ Serie 6 masse variatore ø 20x12

APPLICABILITÀ

Minarelli / Yamaha 125-150 cc

Codice	Colore	Peso	Codice	Colore	Peso	Codice	Colore	Peso
9916120	VERDE	8	9915270	GRIGIO	9	9916200	MARRONE	10,5
9916140	NERO	8,5	9916160	AZZURRO	9,5	9916220	BLU	11

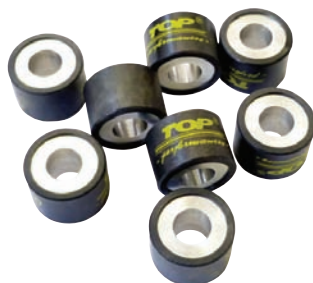

◀ Serie 8 masse variatore ø 20x12

APPLICABILITÀ

Minarelli / Yamaha 250 cc

Codice	Colore	Peso	Codice	Colore	Peso	Codice	Colore	Peso
9918280	VERDE	8	9918310	VIOLA	10	9918040	ROSSO	13
9918290	NERO	8,5	9918320	MARRONE	10,5	9918020	GIALLO	14
9918270	GRIGIO	9	9918330	BLU	11			
9918300	AZZURRO	9,5	9918060	BIANCO	12			



MASSE VARIATORE



◀ Serie 6 masse variatore ø 20x15

APPLICABILITÀ

Kymco 125/150 - Honda SH 125/150

Codice	Colore	Peso
9924280	ROSSO	9
9916650	GIALLO	10
9916670	VERDE	11

Codice	Colore	Peso
9924320	MARRONE	12
9916690	NERO	13
9915820	ROSSO	13,5

Codice	Colore	Peso
9915150	GRIGIO	14,5
9916710	BLU	15,5

◀ Serie 6 masse variatore ø 20x17

APPLICABILITÀ

Aprilia - Peugeot e Variatori Top Performances TPR cod. 9923460 - 9923550 - 9923600 - 9923650

Codice	Colore	Peso
9922490	ROSSO	6,8
9922510	VERDE	7,5
9916240	GIALLO	8
9916260	VERDE	8,5
9923590	BLU	9
9915310	GRIGIO	9,5

Codice	Colore	Peso
9923510	GIALLO	10
9922530	BIANCO	10,5
9916320	VIOLA	11
9924450	PORPORA	12
9922550	BLU	12,5
9922570	GIALLO	13

Codice	Colore	Peso
9922590	ROSA	13,5
9923620	ROSSO	14
9922630	NERO	14,5
9922650	AZZURRO	15
9922670	NEUTRO	15,5
9922690	ARANCIONE	16

◀ Serie 6 masse variatore ø 20,6x17,1

APPLICABILITÀ

Aprilia - Gilera - Piaggio

Codice	Colore	Peso
9932790	NERO	10,7

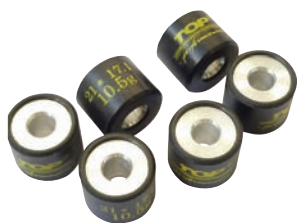

◀ Serie 6 masse variatore ø 21x17,1

APPLICABILITÀ

Aprilia - Gilera - Piaggio

Codice	Colore	Peso
9931870	NERO	10,5

Codice	Colore	Peso
9931880	NERO	13,8



◀ Serie 6 masse variatore ø 23x18

APPLICABILITÀ

Honda - Kymko e Variatori Top Performances TPR cod. 9923670 - 9923750 - 9923790

Codice	Colore	Peso	Codice	Colore	Peso	Codice	Colore	Peso
9931410	NERO	10	9923810	NEUTRO	15	9932390	NERO	19
9931420	NERO	11	9924470	ROSSO	16	9916080	VERDE	20
9916020	BIANCO	13	9931890	NERO	17,5	9916100	NERO	22
9916040	ROSSO	14	9916060	GIALLO	18	9915990	ORO	27

◀ Serie 6 masse variatore ø 23,8x18

APPLICABILITÀ

Suzuki

Codice	Colore	Peso	Codice	Colore	Peso	Codice	Colore	Peso
9918390	VERDE	27	9918370	NERO	29	9918350	NEUTRO	31

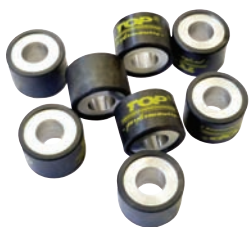

◀ Serie 8 masse variatore ø 25x15

APPLICABILITÀ

Yamaha

Codice	Colore	Peso	Codice	Colore	Peso	Codice	Colore	Peso
9924590	PORPORA	10	9922130	ROSSO	14	9922210	GIALLO	18
9924610	NERO	11	9922150	VERDE	15	9922230	MARRONE	19
9924630	NEUTRO	12	9922170	BIANCO	16	9922250	ROSA	20
9924650	ARANCIONE	13	9922190	BLU	17			

◀ Serie 8 masse variatore ø 25x17

APPLICABILITÀ

Piaggio

Codice	Colore	Peso	Codice	Colore	Peso	Codice	Colore	Peso
9924490	ROSSO	14	9924530	BIANCO	16	9924570	BLU	20,5
9924510	VERDE	15	9924550	MARRONE	17			



◀ Serie 6 masse variatore ø 25x22,10

APPLICABILITÀ

Piaggio

Codice	Colore	Peso	Codice	Colore	Peso
9922270	ROSSO	20	9922310	BIANCO	25
9922290	VERDE	22	9922330	BLU	28,5

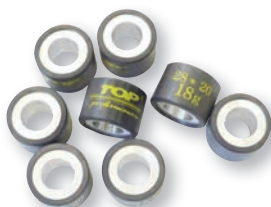

◀ Serie 8 masse variatore ø 26x12,90

APPLICABILITÀ

Suzuki

Codice	Colore	Peso	Codice	Colore	Peso	Codice	Colore	Peso
9922370	VERDE	17	9922410	BLU	19	9922350	ROSSO	16
9922390	BIANCO	18	9918410	NEUTRO	21	9922330	BLU	28,5

◀ Serie 8 masse variatore ø 28x20

APPLICABILITÀ

Honda SW-T 400 [FJS] 400 4T 09-13, Silver Wing 400 [FJS] 400 4T 06-08, SW-T 600 [FJS] 600 4T 11-13, Silver Wing 600 [FJS] 600 4T 01-10

Codice	Colore	Peso	Codice	Colore	Peso
9931810	NERO	18	9931840	NERO	25
9931820	NERO	20	9931860	NERO	28
9931830	NERO	22			



◀ **cod. 9923030**
Convertitore di coppia per motori scooter 50 cc Minarelli/Yamaha

APPLICABILITÀ

- Aprilia** Amico 50 2T 94-94, Amico 50 2T 96-98, Amico GL/GLE 50 2T 93-95, Amico LX/Sport/Cat 50 2T 92-93, Area 51 50 2T 98-00, Gulliver 50 2T 95-98, Gulliver LC 50 2T 96-98, Rally 50 2T 95-03, Rally Liquid Cooled 50 2T 96-99, SR (Orizzontale) 50 2T 94-96, SR (Verticale) 50 2T 93-93, SR Liquid Cooled 50 2T 94-96, SR Recing 50 2T 97-99, SR Stealth 50 2T 97-99, SR WWW 50 2T 97-01, Scarabeo 50 2T 93-05, Sonic 50 2T 98-07, Sonic GP 50 2T 98-08
- Atala** Carosello 50 2T -00
- Benelli** 491 GT 50 2T 98-99, 491 RR 50 2T 99-01, 491 Racing 50 2T 98-99, 491 SP 50 2T 99-99, 491 ST 50 2T 99-01, 491 Sport 50 2T 98-99, K2 50 2T 98-01, K2 Liquid Cooled 50 2T 98-01, Naked 50 2T 02-02, Pepe 50 2T 99-01, Pepe 50 2T 10-10, Pepe LX 50 2T 03-04, Pepe LX 50 2T 07-09, Pepe Old 50 2T 07-09, Pepe Old 50 2T 11-11, Quattrononex 50 2T 08-11
- Beta** Ark 50 2T 96-08, Ark LC 50 2T 96-08, Chrono 50 2T 96-00, Eikon 50 2T 99-03, Quadra 50 2T 95-00, Tempo 50 2T 95-00
- CPI** Aragon 50 2T 03-03, Hussar 50 2T 03-03, Oliver 50 2T 03-03, Pop Corn 50 2T 03-03
- Explorer** Cracker 50 2T 03-03
- Italjet** Dragster 50 2T -00
- KTM** K50 50 2T -00
- Keeway** ATV 50 EC2 50 2T 06-06, ATV OFF ROAD 50 2T 07-07, F-Act 50 2T 07-08, Flash 50 2T 07-08, Focus 50 2T 06-06, Goccia 50 2T 09-09, Hurricane 50 2T 06-08, Matrix 50 2T 06-08, Pixel Euro 2 50 2T -00, RY8 50 2T 08-08
- Macal** Thunder 50 2T -00

- Malaguti** Centro 50 2T -00, Ciak 50 2T -00, Ciak Euro 2,3 50 2T 03-03, Ciak Euro 2 50 2T 01-03, Ciak Master Euro 2 50 2T 06-06, F10 50 2T -00, F10 Euro 2 50 2T -00, F10 Euro 2,3 50 2T 03-04, F10 Restyling Euro 2 50 2T 06-06, F10 Wap Euro 2 50 2T -00, F12 Phantom 50 2T -00, F12 Phantom Euro 2 50 2T 02-02, F12 Phantom Euro 2,3 50 2T 03-04, F12 Phantom LC 50 2T -00, F12 Phantom LC Euro 2,3 50 2T 03-04, F12 R Phantom 50 2T 07-07, F12 R Phantom LC 50 2T 07-09, F12 Restyling Euro 1 50 2T 99-02, F12 Restyling Euro 2 50 2T 06-06, F12 Restyling LC Euro 2 50 2T 06-06, F15 Firefox Euro 2 50 2T 02-06, F15 Firefox Euro 2,3 50 2T 03-04, Yesterday 50 2T 97-00

- Mbk** Booster 50 2T -00, Booster Euro 2 50 2T 04-04, Booster NG 50 2T 03-00, Booster Rocket 50 2T 97-98, Booster Spirit 50 2T 03-00, Booster Track 50 2T 96-98, Evolis 50 2T 92-95, Fizz 50 2T 94-95, Flipper 50 2T -00, Flipper Euro 2 50 2T 03-03, Forte 50 2T 94-96, Mach G 50 2T 02-04, Mach G LC 50 2T 02-04, Nitro 50 2T -00, Nitro Euro 2 50 2T 03-03, Ovetto 50 2T -00, Ovetto Euro 2 50 2T 02-02, Stunt 50 2T 00-02

- Motron** Syncro 50 2T -00, Thunder 50 2T -00

- Rieju** First 50 2T -00, Windy 50 2T -00
- Yamaha** Aerox 50 2T -00, Aerox Euro 2 50 2T 03-03, Axis 50 2T 95-96, BWS 50 2T -00, BWS Bump 50 2T 97-98, BWS Euro 2 50 2T 03-03, BWS NG 50 2T -00, BWS NG Euro 2 50 2T 03-03, Breeze 50 2T 94-95, Jog 50 2T -00, Jog R 50 2T 02-10, Jog R LC 50 2T -00, Neo's 50 2T -00, Neo's Euro 2 50 2T 02-02, Slider 50 2T 00-02, Spy 50 2T 95-98, Why 50 2T -00, Why Euro 2 50 2T 03-03, Zest 50 2T -00, Zuma 50 2T 97-01

RICAMBI

9913790	Molla (carico 26 kg)
---------	----------------------



◀ **cod. 9923150**
Convertitore di coppia per motori scooter 50 cc Piaggio

APPLICABILITÀ

- Aprilia** Mojito 50 2T -, SR R 50 2T 04-09, SR R FACTORY Carburatore 50 2T -, SR R FACTORY IE 50 2T -, SR Street Carburatore 50 2T 03-12, Scarabeo 2T EU2 Motore Piaggio 50 2T 10-12, Scarabeo 2T Net 50 2T 09-10, Scarabeo 4T 50 4T 02-06, Scarabeo 4T 4V 50 4T-4V 10-12, Scarabeo 4T 4V NET 50 4T-4V 09-10, Scarabeo 4T Restyling EU3 50 4T 06-09, Scarabeo Quattro 50 4T-4V 09-09, Scarabeo Street 50 2T 05-06, Scarabeo Street 2T Restyling 50 2T 06-09, Sport City One 2T 50 2T 08-11, Sport City One 4T 50 4T 08-10
- Derbi** Atlantis 2T 50 2T 10-10, Atlantis 2T EU2 50 2T 07-09, Atlantis O2 50 2T 02-02, Atlantis O2 Bullet 50 2T 03-05, Atlantis O2 City 50 2T 03-06, Atlantis O2 Red Bullet 50 2T 03-03, Atlantis O2 Two Chic 50 2T 05-05, Boulevard 50 2T 09-12, GP1 50 2T 01-03, GP1 EU2 50 2T 05-05, GP1 Open EU2 50 2T 06-09, GP1 Race EU2 50 2T 05-07, Sonar 2T 50 2T 09-09
- Gilera** Easy Moving 50 2T 95-96, Ice 50 2T 01-05, Runner 50 2T 97-00, Runner Pure Jet 50 2T-IE 02-07, Runner Pure Jet 50 2T-IE 10-11, Runner SP 50 2T 02-06, Stalker 50 2T 97-11, Stalker Naked 50 2T 08-08, Stalker Special Edition 50 2T 07-08, Storm 50 2T 94-95, Storm Euro 2 50 2T 07-07, Typhoon 50 2T 94-97, Typhoon X 50 2T 98-99, Typhoon XR 50 2T 00-00
- Italjet** Jet Set 50 2T -00, Torpedo New 50 2T -00
- Piaggio** Diesis 50 2T 01-01, Fly 2T 50 2T 05-07, Fly 2T 50 2T 10-11, Fly 4T 50 4T 05-07, Fly 4T & 25-30 KM/H 50 4T 08-11, Fly 4T Motore CHN 50 4T 06-07, Free 50 2T 92-94, Free Delivery 50

- 50 2T 97-05, Liberty 2T 50 2T 06-08, Liberty 2T PTT EU2 50 2T 04-05, Liberty 2T RST 50 2T 04-04, Liberty 2T Sport 50 2T 06-08, Liberty 4T 50 4T 00-02, Liberty 4T 50 4T 05-08, Liberty 4T Delivery 50 4T 10-11, Liberty 4T Delivery TNT 50 4T 09-09, Liberty 4T PTT 50 4T 09-11, Liberty 4T RST 50 4T 04-04, Liberty 4T Sport 50 4T 06-08, Liberty MOC 2T & Elle 50 2T 09-12, Liberty MOC 4T & Elle 50 4T 09-11, NRG 50 2T 94-96, NRG Extreme 50 2T 99-00, NRG MC3 50 2T 01-04, NRG Power DD 50 2T 05-11, NRG Power DD Serie Speciale 50 2T 07-11, NRG Power DT 50 2T 06-11, NRG Power DT Serie Speciale 50 2T 07-08, NRG Power Pure Jet 50 2T-IE 04-05, NRG Power PureJet 50 2T-IE 06-11, NRG PureJet 50 2T-IE 02-04, NRG PureJet 50 2T-IE 10-10, NRG RST MC2 50 2T 96-98, NRG 50 2T 95-96, Quartz 50 2T 92-96, Sfera 50 2T 91-93, Sfera Maquillage 2 50 2T 94-94, Sfera RST 50 2T 95-97, Typhoon 50 2T 01-09, Typhoon 2T E2 50 2T 10-12, Typhoon 2T E3 CH 50 2T 11-11, Vespa ET2 50 2T 97-05, Vespa ET2 iniezione 50 2T 97-00, Vespa ET4 50 4T 00-05, Vespa LX 2T 50 2T 05-08, Vespa LX 2T FL 50 2T 09-10, Vespa LX 2T Touring 50 2T 10-11, Vespa LX 4T 50 4T 05-08, Vespa LX 4T 4V 50 4T-4V 09-11, Vespa LX 4T 4V Touring 50 4T-4V 10-11, Vespa LXV 2T 50 2T 06-08, Vespa LXV 2T NAVY 50 2T 08-08, Vespa S 2T & College 50 2T 07-12, Vespa S 4T 4V & College 50 4T-4V 08-11, Zip 50 2T 92-93, Zip 50 2T 95-96, Zip 2T 50 2T 08-12, Zip 4T 50 4T 00-12, Zip Bimodale 50 2T 94-97, Zip Fast Rider 50 2T 93-94, Zip Fast Rider RST 50 2T 96-97, Zip LC 50 2T 00-04, Zip RST 50 2T 96-99, Zip Sp 50 2T 96-04, Zip Sp Euro 2 50 2T 06-12

RICAMBI

9912590	Molla (carico 37 kg)
---------	----------------------



◀ **cod. 9930200** **RACING**
Coperchio trasmissione con raffreddamento forzato
 Per motori serie Minarelli/Yamaha 50 cc tipo orizzontale lungo

APPLICABILITÀ

Aprilia	Area 51 50 2T 98-00, Gulliver 50 2T 95-98, Gulliver LC 50 2T 96-98, Rally 50 2T 95-03, Rally Liquid Cooled 50 2T 96-99, SR (Orizzontale) 50 2T 94-96, SR Liquid Cooled 50 2T 94-96, SR Recing 50 2T 97-99, SR Stealth 50 2T 97-99, SR WWW 50 2T 97-01, Scarabeo 50 2T 93-05	Macal	Thunder 50 2T -00
Atala	Carosello 50 2T -00	Malaguti	Centro 50 2T -00, Ciak 50 2T -00, Ciak Euro 2 2,3 50 2T 03-03, Ciak Euro2 50 2T 01-03, Ciak Master Euro 2 50 2T 06-06, F12 Phantom 50 2T -00, F12 Phantom Euro 2 2,3 50 2T 03-04, F12 Phantom LC 50 2T -00, F12 R Phantom LC 50 2T 07-09, F12 Restyling Euro 2 50 2T 06-06, F15 Firefox 50 2T -00, F15 Firefox Euro 2 50 2T 02-06, F15 Firefox Euro 2 2,3 50 2T 03-04
Benelli	491 GT 50 2T 98-99, 491 RR 50 2T 99-01, 491 Racing 50 2T 98-99, 491 SP 50 2T 99-99, 491 ST 50 2T 99-01, 491 Sport 50 2T 98-99, K2 50 2T 98-01, K2 Liquid Cooled 50 2T 98-01, Naked 50 2T 02-02, Pepe 50 2T 99-01, Pepe LX 50 2T 03-04	Mbk	Flipper 50 2T -00, Flipper Euro 2 50 2T 03-03, Mach G 50 2T 02-04, Mach G LC 50 2T 02-04, Nitro 50 2T -00, Nitro Euro 2 50 2T 03-03, Ovetto 50 2T -00, Ovetto Euro 2 50 2T 02-02
Beta	Ark 50 2T 96-08, Ark LC 50 2T 96-08, Chrono 50 2T 96-00, Eikon 50 2T 99-03, Quadra 50 2T 95-00, Tempo 50 2T 95-00	Motron	Syncro 50 2T -00, Thunder 50 2T -00
Italjet	Dragster 50 2T -00	Rieju	First 50 2T -00, Windy 50 2T -00
KTM	K50 50 2T -00	Yamaha	Aerox 50 2T -00, Aerox Euro 2 50 2T 03-03, Jog R 50 2T 02-10, Jog R LC 50 2T -00, Neo's 50 2T -00, Neo's Euro 2 50 2T 02-02, Why 50 2T -00, Why Euro 2 50 2T 03-03

RICAMBI

9915420	Scodellino dentato
----------------	--------------------



◀ **cod. 9930300** **RACING**
Coperchio scatola ingranaggi Nardo
 Per tutti i motori di derivazione Minarelli/Yamaha 50cc. di tipo orizzontale lungo e verticale

APPLICABILITÀ

Aprilia	Amico 50 2T 94-94, Amico 50 2T 96-98, Amico GL/GLE 50 2T 93-95, Amico LX/Sport/Cat 50 2T 92-93, Area 51 50 2T 98-00, Gulliver 50 2T 95-98, Gulliver LC 50 2T 96-98, Rally 50 2T 95-03, Rally Liquid Cooled 50 2T 96-99, SR (Orizzontale) 50 2T 94-96, SR (Verticale) 50 2T 93-93, SR Liquid Cooled 50 2T 94-96, SR Recing 50 2T 97-99, SR Stealth 50 2T 97-99, SR WWW 50 2T 97-01, Scarabeo 50 2T 93-05	Malaguti	Centro 50 2T -00, Ciak 50 2T -00, Ciak Euro 2 2,3 50 2T 03-03, Ciak Euro2 50 2T 01-03, Ciak Master Euro 2 50 2T 06-06, F12 Phantom 50 2T -00, F12 Phantom Euro 2 50 2T 02-02, F12 Phantom Euro 2 2,3 50 2T 03-04, F12 Phantom LC 50 2T -00, F12 Phantom LC Euro 2 2,3 50 2T 03-04, F12 R Phantom LC 50 2T 07-09, F12 Restyling Euro 1 50 2T 99-02, F12 Restyling Euro 2 50 2T 06-06, F12 Restyling LC Euro 2 50 2T 06-06, F15 Firefox 50 2T -00, F15 Firefox Euro 2 50 2T 02-06, F15 Firefox Euro 2 2,3 50 2T 03-04
Atala	Carosello 50 2T -00	Mbk	Booster 50 2T -00, Booster Euro 2 50 2T 04-04, Booster NG 50 2T 03-00, Booster Rocket 50 2T 97-98, Booster Spirit 50 2T 03-00, Booster Track 50 2T 96-98, Flipper 50 2T -00, Flipper Euro 2 50 2T 03-03, Mach G 50 2T 02-04, Mach G LC 50 2T 02-04, Nitro 50 2T -00, Nitro Euro 2 50 2T 03-03, Ovetto 50 2T -00, Ovetto Euro 2 50 2T 02-02, Stunt 50 2T 00-02
Benelli	491 GT 50 2T 98-99, 491 RR 50 2T 99-01, 491 Racing 50 2T 98-99, 491 SP 50 2T 99-99, 491 ST 50 2T 99-01, 491 Sport 50 2T 98-99, K2 50 2T 98-01, K2 Liquid Cooled 50 2T 98-01, Naked 50 2T 02-02, Pepe 50 2T 99-01, Pepe LX 50 2T 03-04	Motron	Syncro 50 2T -00, Thunder 50 2T -00
Beta	Ark 50 2T 96-08, Ark LC 50 2T 96-08, Chrono 50 2T 96-00, Eikon 50 2T 99-03, Quadra 50 2T 95-00, Tempo 50 2T 95-00	Rieju	First 50 2T -00, Windy 50 2T -00
Italjet	Dragster 50 2T -00	Yamaha	Aerox 50 2T -00, Aerox Euro 2 50 2T 03-03, BWS 50 2T -00, BWS Bump 50 2T 97-98, BWS Euro 2 50 2T 03-03, BWS NG 50 2T -00, BWS NG Euro 2 50 2T 03-03, Jog R 50 2T 02-10, Jog R LC 50 2T -00, Neo's 50 2T -00, Neo's Euro 2 50 2T 02-02, Slider 50 2T 00-02, Spy 50 2T 95-98, Why 50 2T -00, Why Euro 2 50 2T 03-03, Zuma 50 2T 97-01
KTM	K50 50 2T -00		
Macal	Thunder 50 2T -00		



◀ **cod. 9908010**
Serie 3 molle contrasto variatore per motori 50 cc Minarelli/Yamaha

◀ **cod. 9914440**
Molla contrasto variatore colore verde (carico 25 Kg)

◀ **cod. 9914430**
Molla contrasto variatore colore viola (carico 27 Kg)

◀ **cod. 9914420**
Molla contrasto variatore colore rosa (carico 29 Kg)

APPLICABILITÀ

Aprilia	Amico 50 2T 94-94, Amico 50 2T 96-98, Amico GL/GLE 50 2T 93-95, Amico LX/Sport/Cat 50 2T 92-93, Area 51 50 2T 98-00, Gulliver 50 2T 95-98, Gulliver LC 50 2T 96-98, Rally 50 2T 95-03, Rally Liquid Cooled 50 2T 96-99, SR (Orizzontale) 50 2T 94-96, SR (Verticale) 50 2T 93-93, SR Liquid Cooled 50 2T 94-96, SR Recing 50 2T 97-99, SR Stealth 50 2T 97-99, SR WWW 50 2T 97-01, Scarabeo 50 2T 93-05, Sonic 50 2T 98-07, Sonic GP 50 2T 98-08
Atala	Carosello 50 2T -00
Benelli	491 GT 50 2T 98-99, 491 RR 50 2T 99-01, 491 Racing 50 2T 98-99, 491 SP 50 2T 99-99, 491 ST 50 2T 99-01, 491 Sport 50 2T 98-99, K2 50 2T 98-01, K2 Liquid Cooled 50 2T 98-01, Naked 50 2T 02-02, Pepe 50 2T 99-01, Pepe 50 2T 10-10, Pepe LX 50 2T 03-04, Pepe LX 50 2T 07-09, Pepe Old 50 2T 07-09, Pepe Old 50 2T 11-11, Quattronex 50 2T 08-11
Beta	Ark 50 2T 96-08, Ark LC 50 2T 96-08, Chrono 50 2T 96-00, Eikon 50 2T 99-03, Quadra 50 2T 95-00, Tempo 50 2T 95-00
CPI	Aragon 50 2T 03-03, Hussar 50 2T 03-03, Oliver 50 2T 03-03, Pop Corn 50 2T 03-03

Explorer Cracker 50 2T 03-03
Garelli GPS 50 2T 09-11

Italjet Dragster 50 2T -00

KTM K50 50 2T -00

Keeway F-Act 50 2T 07-08, Flash 50 2T 07-08, Focus 50 2T 06-06, Goccia 50 2T 09-09, Hurricane 50 2T 06-08, Matrix 50 2T 06-08, Pixel Euro 2 50 2T -00, RY8 50 2T 08-08

Macal Sting 50 2T -00, Thunder 50 2T -00

Malaguti Centro 50 2T -00, Ciak 50 2T -00, Ciak Euro 2,3 50 2T 03-03, Ciak Euro2 50 2T 01-03, Ciak Master Euro 2 50 2T 06-06, F10 50 2T -00, F10 Euro 2 50 2T -00, F10 Euro 2,3 50 2T 03-04, F10 Restyling Euro 2 50 2T 06-06, F10 Wap Euro 2 50 2T -00, F12 Phantom 50 2T -00, F12 Phantom Euro 2 50 2T 02-02, F12 Phantom Euro 2,3 50 2T 03-04, F12 Phantom LC 50 2T -00, F12 Phantom LC Euro 2,3 50 2T 03-04, F12 R Phantom 50 2T 07-07, F12 R Phantom LC 50 2T 07-09, F12 Restyling Euro 1 50 2T 99-02, F12 Restyling Euro 2 50 2T 06-06, F12 Restyling LC Euro 2 50 2T 06-06, F15 Firefox 50 2T -00, F15 Firefox Euro 2 50 2T 02-06, F15 Firefox Euro 2,3 50 2T 03-04, Yesterday 50 2T 97-00

Mbk Booster 50 2T -00, Booster Euro 2 50 2T 04-04, Booster NG 50 2T 03-00, Booster Rocket 50 2T 97-98, Booster Spirit 50 2T 03-00, Booster Track 50 2T 96-98, Booster X ie 50 4T-3V 08-08, Evolis 50 2T 92-95, Fizz 50 2T 94-95, Flipper 50 2T -00, Flipper Euro 2 50 2T 03-03, Forte 50 2T 94-96, Mach G 50 2T 02-04, Mach G LC 50 2T 02-04, Nitro 50 2T -00, Nitro Euro 2 50 2T 03-03, Ovetto 50 2T -00, Ovetto 4T 50 4T-3V 09-11, Ovetto Euro 2 50 2T 02-02, Stunt 50 2T 00-02

Motron Sting 50 2T -00, Syncro 50 2T -00, Thunder 50 2T -00

PGO Big Max 50 2T -00

Rieju First 50 2T -00, Windy 50 2T -00

Yamaha Aerox 50 2T -00, Aerox Euro 2 50 2T 03-03, Axis 50 2T 95-96, BWS 50 2T -00, BWS Bump 50 2T 97-98, BWS Euro 2 50 2T 03-03, BWS NG 50 2T -00, BWS NG Euro 2 50 2T 03-03, Breeze 50 2T 94-95, Giggie 50 4T-3V 08-08, Jog R 50 2T 02-10, Jog R LC 50 2T -00, Neo's 50 2T -00, Neo's 4 50 4T-3V 09-11, Neo's Euro 2 50 2T 02-02, Slider 50 2T 00-02, Spy 50 2T 95-98, Why 50 2T -00, Why Euro 2 50 2T 03-03, Zest 50 2T -00, Zuma 50 2T 97-01



◀ **cod. 9908470**
Serie 3 molle contrasto variatore per motori 50 cc Gilera/Piaggio

◀ **cod. 9914800**
Molla contrasto variatore colore verde (carico 35 Kg)

◀ **cod. 9914810**
Molla contrasto variatore colore viola (carico 37,5 Kg)

◀ **cod. 9914820**
Molla contrasto variatore colore rosa (carico 39,5 Kg)

APPLICABILITÀ

Aprilia	Mojito 50 2T -, SR R 50 2T 04-09, SR R FACTORY Carburatore 50 2T -, SR R FACTORY IE 50 2T -, SR Street Carburatore 50 2T 03-12, Scarabeo 2T EU2 Motore Piaggio 50 2T 10-12, Scarabeo 2T Net 50 2T 09-10, Scarabeo 4T 50 4T 02-06, Scarabeo 4T 4V 50 4T-4V 10-12, Scarabeo 4T 4V NET 50 4T-4V 09-10, Scarabeo 4T Restyling EU3 50 4T 06-09, Scarabeo Quattro 50 4T-4V 09-09, Scarabeo Street 50 2T 05-06, Scarabeo Street 2T Restyling 50 2T 06-09, Sport City One 2T 50 2T 08-11, Sport City One 4T 50 4T 08-10
Derbi	Atlantis 2T 50 2T 10-10, Atlantis 2T EU2 50 2T 07-09, Atlantis 4T 50 4T 04-06, Atlantis 4T EU2 50 4T 07-07, Atlantis O2 50 2T 02-02, Atlantis O2 Bullet 50 2T 03-05, Atlantis O2 City 50 2T 03-06, Atlantis O2 Red Bullet 50 2T 03-03, Atlantis O2 Two Chic 50 2T 05-05, Boulevard 50 2T 09-12, Boulevard 4T EU2 25KM/H 50 4T -, GP1 50 2T 01-03, GP1 EU2 50 2T 05-05, GP1 Open EU2 50 2T 06-09, GP1 Race EU2 50 2T 05-07, Sonar 2T 50 2T 09-09
Gilera	DNA 50 2T 00-02, DNA 50 2T 05-07, DNA GP Experience 50 2T 03-04, Easy Moving 50 2T 95-96, Ice 50 2T 01-05, Runner 50 2T 97-00, Runner Poggiali 50 2T 02-02, Runner Pure Jet 50 2T-IE 02-07, Runner Pure Jet 50 2T-IE 10-11, Runner Pure Jet ST 50 2T-IE 08-08, Runner SP 50 2T 02-07, Runner SP 50 2T 10-12,

Runner SP ST & Simoncelli 50 2T 08-09, Runner SP Special Edition 50 2T 07-07, Stalker 50 2T 97-11, Stalker Naked 50 2T 08-08, Stalker Special Edition 50 2T 07-08, Storm 50 2T 94-95, Storm Euro 2 50 2T 07-07, Typhoon 50 2T 94-97, Typhoon X 50 2T 98-99, Typhoon XR 50 2T 00-00

Italjet Jet Set 50 2T -00, Torpedo 50 4T -00, Torpedo New 50 2T -00

Malaguti Centro Euro 2 50 4T 08-08, Centro SL 4T 50 4T 10-10, Ciak Master 4T 50 4T 05-06, Ciak Master Euro 2 50 4T 05-06

Piaggio Diesis 50 2T 01-01, Fly 2T 50 2T 05-07, Fly 2T 50 2T 10-11, Fly 4T 50 4T 05-07, Fly 4T & 25-30 KM/H 50 4T 08-11, Fly 4T Motore CHN 50 4T 06-07, Free 50 2T 92-94, Free Delivery 50 2T 00-01, Free FL 50 2T 95-02, Liberty 50 2T 97-05, Liberty 2T 50 2T 06-08, Liberty 2T PTT EU2 50 2T 04-05, Liberty 2T RST 50 2T 04-04, Liberty 2T Sport 50 2T 06-08, Liberty 4T 50 4T 00-02, Liberty 4T 50 4T 05-08, Liberty 4T Delivery - Single 50 4T 10-12, Liberty 4T Delivery TNT 50 4T 09-09, Liberty 4T PTT - DOUBLE 50 4T 09-12, Liberty 4T RST 50 4T 04-04, Liberty 4T Sport 50 4T 06-08, Liberty MOC 2T & Elle 50 2T -, Liberty MOC 4T & Elle 50 4T 09-13, NRG 50 2T 94-96, NRG Extreme 50 2T 99-00,

NRG MC3 50 2T 01-04, NRG Power DD 50 2T 05-11, NRG Power DD Serie Speciale 50 2T 07-11, NRG Power DT 50 2T 06-11, NRG Power DT Serie Speciale 50 2T 07-08, NRG Power Pure Jet 50 2T-IE 04-05, NRG Power PureJet 50 2T-IE 06-11, NRG PureJet 50 2T-IE 02-04, NRG PureJet 50 2T-IE 10-10, NRG RST MC2 50 2T 96-98, NTT 50 2T 95-96, Quartz 50 2T 92-96, Sfera 50 2T 91-93, Sfera Maquillage 2 50 2T 94-94, Sfera RST 50 2T 95-97, Typhoon 50 2T 01-09, Typhoon 2T E2 50 2T 10-12, Typhoon 2T E3 CH 50 2T 11-11, Vespa ET2 50 2T 97-05, Vespa ET2 iniezione 50 2T 97-00, Vespa ET4 50 4T 00-05, Vespa LX 2T 50 2T 05-08, Vespa LX 2T FL 50 2T 09-10, Vespa LX 2T Touring 50 2T 10-11, Vespa LX 4T 50 4T 05-08, Vespa LX 4T 4V 50 4T-4V 09-11, Vespa LX 4T 4V Touring 50 4T-4V 10-11, Vespa LXV 2T 50 2T 06-08, Vespa LXV 2T NAVY 50 2T 08-08, Vespa S 2T & College 50 2T 07-12, Vespa S 4T 4V & College 50 4T-4V 08-11, Zip 50 2T 92-93, Zip 50 2T 95-96, Zip 2T 50 2T 08-12, Zip 4T 50 4T 00-12, Zip Bimodale 50 2T 94-97, Zip Fast Rider 50 2T 93-94, Zip Fast Rider RST 50 2T 96-97, Zip LC 50 2T 00-04, Zip RST 50 2T 96-99, Zip Sp 50 2T 96-04, Zip Sp Euro 2 50 2T 06-12



cod. **9925630** **RACING**
Serie 3 molle contrasto variatore per motori 50 cc Gilera/Piaggio Racing

cod. **9914450**
Molla contrasto variatore colore giallo (carico 37 Kg)

cod. **9914460**
Molla contrasto variatore colore verde (carico 41 Kg)

cod. **9924970**
Molla contrasto variatore colore rosso (carico 46 Kg)

APPLICABILITÀ

Aprilia Mojito 50 2T -, SR R 50 2T 04-09, SR R FACTORY Carburatore 50 2T -, SR R FACTORY IE 50 2T -, SR Street Carburatore 50 2T 03-12, Scarabeo 2T EU2 Motore Piaggio 50 2T 10-12, Scarabeo 2T Net 50 2T 09-10, Scarabeo 4T 50 4T 02-06, Scarabeo 4T 4V 50 4T-4V 10-12, Scarabeo 4T 4V NET 50 4T-4V 09-10, Scarabeo 4T Restyling EU3 50 4T 06-09, Scarabeo Quattro 50 4T-4V 09-09, Scarabeo Street 50 2T 05-06, Scarabeo Street 2T Restyling 50 2T 06-09, Sport City One 2T 50 2T 08-11, Sport City One 4T 50 4T 08-10

Derbi Atlantis 2T 50 2T 10-10, Atlantis 2T EU2 50 2T 07-09, Atlantis 4T 50 4T 04-06, Atlantis 4T EU2 50 4T 07-07, Atlantis O2 50 2T 02-02, Atlantis O2 Bullet 50 2T 03-05, Atlantis O2 City 50 2T 03-06, Atlantis O2 Red Bullet 50 2T 03-03, Atlantis O2 Two Chic 50 2T 05-05, Boulevard 50 2T 09-12, Boulevard 4T EU2 25KM/H 50 4T -, GP1 50 2T 01-03, GP1 EU2 50 2T 05-05, GP1 Open EU2 50 2T 06-09, GP1 Race EU2 50 2T 05-07, Sonar 2T 50 2T 09-09

Gilera DNA 50 2T 00-02, DNA 50 2T 05-07, DNA GP Experience 50 2T 03-04, Easy Moving 50 2T 95-96, Ice 50 2T 01-05, Runner 50 2T 97-00, Runner Poggiali 50 2T 02-02, Runner Pure Jet 50 2T-IE 02-07, Runner Pure Jet 50 2T-IE 10-11, Runner Pure Jet ST 50 2T-IE 08-08, Runner SP 50 2T 02-07, Runner SP 50 2T 10-12, Runner SP ST & Simoncelli 50 2T 08-09, Runner SP Special Edition 50 2T 07-07, Stalker 50 2T 97-11, Stalker Naked 50 2T 08-08,

Stalker Special Edition 50 2T 07-08, Storm 50 2T 94-95, Storm Euro 2 50 2T 07-07, Typhoon 50 2T 94-97, Typhoon X 50 2T 98-99, Typhoon XR 50 2T 00-00

Italjet Jet Set 50 2T -00, Torpedo 50 4T -00, Torpedo New 50 2T -00

Malaguti Centro Euro 2 50 4T 08-08, Centro SL 4T 50 4T 10-10, Ciak Master 4T 50 4T 05-06, Ciak Master Euro 2 50 4T 05-06

Piaggio Diesis 50 2T 01-01, Fly 2T 50 2T 05-07, Fly 2T 50 2T 10-11, Fly 4T 50 4T 05-07, Fly 4T & 25-30 KM/H 50 4T 08-11, Fly 4T Motore CHN 50 4T 06-07, Free 50 2T 92-94, Free Delivery 50 2T 00-01, Free FL 50 2T 95-02, Liberty 50 2T 97-05, Liberty 2T 50 2T 06-08, Liberty 2T PTT EU2 50 2T 04-05, Liberty 2T RST 50 2T 04-04, Liberty 2T Sport 50 2T 06-08, Liberty 4T 50 4T 00-02, Liberty 4T 50 4T 05-08, Liberty 4T Delivery - Single 50 4T 10-12, Liberty 4T Delivery TNT 50 4T 09-09, Liberty 4T PTT - DOUBLE 50 4T 09-12, Liberty 4T RST 50 4T 04-04, Liberty 4T Sport 50 4T 06-08, Liberty MOC 2T & Elle 50 2T -, Liberty MOC 4T & Elle 50 4T 09-13, NRG 50 2T 94-96, NRG Extreme 50 2T 99-00, NRG MC3 50 2T 01-04, NRG Power DD 50 2T 05-13, NRG Power DD Serie Speciale 50 2T -, NRG Power DT 50 2T 06-11, NRG Power DT Serie Speciale 50 2T 07-08, NRG Power Pure Jet 50 2T-IE 04-05, NRG Power PureJet 50 2T-IE 06-11, NRG PureJet 50 2T-IE 02-04, NRG PureJet 50 2T-IE 10-10, NRG RST MC2 50 2T 96-98, NTT 50 2T 95-96,

Quartz 50 2T 92-96, Sfera 50 2T 91-93, Sfera Maquillage 2 50 2T 94-94, Sfera RST 50 2T 95-97, Typhoon 50 2T 01-11, Typhoon 2T E2 50 2T 10-12, Typhoon 2T E3 CH 50 2T 11-11, Vespa ET2 50 2T 97-05, Vespa ET2 iniezione 50 2T 97-00, Vespa ET4 50 4T 00-05, Vespa LX 2T 50 2T 05-08, Vespa LX 2T FL 50 2T 09-10, Vespa LX 2T Touring 50 2T 10-11, Vespa LX 4T 50 4T 05-08, Vespa LX 4T 4V 50 4T-4V 09-11, Vespa LX 4T 4V Touring 50 4T-4V 10-11, Vespa LXV 2T 50 2T -, Vespa LXV 2T NAVY 50 2T 08-08, Vespa S 2T & College 50 2T 07-12, Vespa S 4T 4V & College 50 4T-4V 08-11, Zip 50 2T 92-93, Zip 50 2T 95-96, Zip 2T 50 2T -, Zip 4T 50 4T 00-13, Zip Bimodale 50 2T 94-97, Zip Fast Rider 50 2T 93-94, Zip Fast Rider RST 50 2T 96-97, Zip LC 50 2T 00-04, Zip RST 50 2T 96-99, Zip Sp 50 2T 96-04, Zip Sp Euro 2 50 2T



◀ cod. **9925620** **RACING**
Serie 3 molle contrasto variatore per motori 50 cc Minarelli/Yamaha Racing

◀ cod. **9914470**
Molla contrasto variatore colore giallo (carico 26 kg)

◀ cod. **9914480**
Molla contrasto variatore colore verde (carico 29 kg)

◀ cod. **9924840**
Molla contrasto variatore colore rosso (carico 32 kg)

APPLICABILITÀ

Aprilia	Amico 50 2T 94-94, Amico 50 2T 96-98, Amico GL/GLE 50 2T 93-95, Amico LX/Sport/Cat 50 2T 92-93, Area 51 50 2T 98-00, Gulliver 50 2T 95-98, Gulliver LC 50 2T 96-98, Rally 50 2T 95-03, Rally Liquid Cooled 50 2T 96-99, SR (Orizzontale) 50 2T 94-96, SR (Verticale) 50 2T 93-93, SR Liquid Cooled 50 2T 94-96, SR Recing 50 2T 97-99, SR Stealth 50 2T 97-99, SR WWW 50 2T 97-01, Scarabeo 50 2T 93-05, Sonic 50 2T 98-07, Sonic GP 50 2T 98-08	Explorer	Cracker 50 2T 03-03	Mbk	Booster 50 2T -00, Booster Euro 2 50 2T 04-04, Booster NG 50 2T 03-00, Booster Rocket 50 2T 97-98, Booster Spirit 50 2T 03-00, Booster Track 50 2T 96-98, Booster X ie 50 4T-3V 08-08, Evois 50 2T 92-95, Fizz 50 2T 94-95, Flipper 50 2T -00, Flipper Euro 2 50 2T 03-03, Forte 50 2T 94-96, Mach G 50 2T 02-04, Mach GLC 50 2T 02-04, Nitro 50 2T -00, Nitro Euro 2 50 2T 03-03, Ovetto 50 2T -00, Ovetto 4T 50 4T-3V 09-11, Ovetto Euro 2 50 2T 02-02, Stunt 50 2T 00-02
Atala	Carosello 50 2T -00	Garelli	GPS 50 2T 09-11	Motron	Sting 50 2T -00, Syncro 50 2T -00, Thunder 50 2T -00
Benelli	491 GT 50 2T 98-99, 491 RR 50 2T 99-01, 491 Racing 50 2T 98-99, 491 SP 50 2T 99-99, 491 ST 50 2T 99-01, 491 Sport 50 2T 98-99, K2 50 2T 98-01, K2 Liquid Cooled 50 2T 98-01, Naked 50 2T 02-02, Pepe 50 2T 99-01, Pepe 50 2T 10-10, Pepe LX 50 2T 03-04, Pepe LX 50 2T 07-09, Pepe Old 50 2T 07-09, Pepe Old 50 2T 11-11, Quattrononex 50 2T 08-11	Italjet	Dragster 50 2T -00	PGO	Big Max 50 2T -00
Beta	Ark 50 2T 96-08, Ark LC 50 2T 96-08, Chrono 50 2T 96-00, Eikon 50 2T 99-03, Quadra 50 2T 95-00, Tempo 50 2T 95-00	KTM	K50 50 2T -00	Rieju	First 50 2T -00, Windy 50 2T -00
CPI	Aragon 50 2T 03-03, Hussar 50 2T 03-03, Oliver 50 2T 03-03, Pop Corn 50 2T 03-03	Keeway	F-Act 50 2T 07-08, Flash 50 2T 07-08, Focus 50 2T 06-06, Goccia 50 2T 09-09, Hurricane 50 2T 06-08, Matrix 50 2T 06-08, Pixel Euro 2 50 2T -00, RY8 50 2T 08-08	Yamaha	Aerox 50 2T -00, Aerox Euro 2 50 2T 03-03, Axis 50 2T 95-96, BWS 50 2T -00, BWS Bump 50 2T 97-98, BWS Euro 2 50 2T 03-03, BWS NG 50 2T -00, BWS NG Euro 2 50 2T 03-03, Breeze 50 2T 94-95, Giggie 50 4T-3V 08-08, Jog R 50 2T 02-10, Jog R LC 50 2T -00, Neo's 50 2T -00, Neo's 4 50 4T-3V 09-11, Neo's Euro 2 50 2T 02-02, Slider 50 2T 00-02, Spy 50 2T 95-98, Why 50 2T -00, Why Euro 2 50 2T 03-03, Zest 50 2T -00, Zuma 50 2T 97-01
		Macal	Sting 50 2T -00, Thunder 50 2T -00		
		Malaguti	Centro 50 2T -00, Ciak 50 2T -00, Ciak Euro 2 2,3 50 2T 03-03, Ciak Euro2 50 2T 01-03, Ciak Master Euro 2 50 2T 06-06, F10 50 2T -00, F10 Euro 2 50 2T -00, F10 Euro 2 2,3 50 2T 03-04, F10 Restyling Euro 2 50 2T 06-06, F10 Wap Euro 2 50 2T -00, F12 Phantom 50 2T -00, F12 Phantom Euro 2 50 2T 02-02, F12 Phantom Euro 2 2,3 50 2T 03-04, F12 Phantom LC 50 2T -00, F12 Phantom LC Euro 2 2,3 50 2T 03-04, F12 R Phantom 50 2T 07-07, F12 R Phantom LC 50 2T 07-09, F12 Restyling Euro 1 50 2T 99-02, F12 Restyling Euro 2 50 2T 06-06, F12 Restyling LC Euro 2 50 2T 06-06, F15 Firefox 50 2T -00, F15 Firefox Euro 2 50 2T 02-06, F15 Firefox Euro 2,3 50 2T 03-04, Yesterday 50 2T 97-00		



◀ cod. **9914750**
Molla contrasto variatore colore verde per motori 50 cc Suzuki (carico 35,5 kg)

APPLICABILITÀ

Atala	Hacker 50 2T -00, Vamos 50 2T -00	Malaguti	Crosser CR1 50 2T 95-98
Benelli	491 RR Morini 50 2T 03-04, 491 ST Morini 50 2T 03-03, Naked Morini 50 2T 03-04	Suzuki	AH Address 50 2T 92-95, AJ ZZ 50 2T 95-97, AP 50 2T 94-97, Estilete UF 50 2T 00-00, Katana 50 2T 97-04, Street Magic 50 2T 98-98, Zillion 50 2T 99-99
Italjet	Formula 50 2T -00, Velocifero 50 2T -00		



◀ cod. **9914760**
Molla contrasto variatore colore rosa per motori 50 cc Suzuki (carico 40 kg)

APPLICABILITÀ

Atala	Hacker 50 2T -00, Vamos 50 2T -00	Malaguti	Crosser CR1 50 2T 95-98
Benelli	491 RR Morini 50 2T 03-04, 491 ST Morini 50 2T 03-03, Naked Morini 50 2T 03-04	Suzuki	AH Address 50 2T 92-95, AJ ZZ 50 2T 95-97, AP 50 2T 94-97, Estilete UF 50 2T 00-00, Katana 50 2T 97-04, Street Magic 50 2T 98-98, Zillion 50 2T 99-99
Italjet	Formula 50 2T -00, Velocifero 50 2T -00		



cod. 9926760

Molla contrasto variatore colore giallo per Yamaha X-Max 125 cc (carico 44 kg)

APPLICABILITÀ

Mbk Cityliner 125 EU3 125 4T-4V 08-10, Skycruiser 125 125 4T-4V 07-07

Yamaha X-City 125 EU3 125 4T-4V 08-11, X-Max R 125 125 4T-4V 06-16, X-Max R 125 ABS 125 4T-4V 11-11, X-Max RA 125 ABS 125 4T-4V 13-16

cod. 9926770

Molla contrasto variatore colore bianco per Honda SH 125/150 cc (carico 44,5 kg)

APPLICABILITÀ

Honda @ [NES] 125 125 4T 00-06, Dylan 125 [SES] 125 4T 02-04, PS I 125 [PES] 125 4T 06-10, Pantheon 125 IE [FES] 125 4T-2V 03-05, SH 125 125 4T-2V 01-04, SH IE 125 Scoopy 125 4T-2V 05-12, Silver Wing 125 [FES] 125 4T-2V 07-12, @ [NES] 150 150 4T 00-06, Dylan 150 [SES] 150 4T 02-04, PS I 150 [PES] 150 4T 06-10, Pantheon 150 IE [FES] 150 4T-2V 03-05, SH 150 150 4T-2V 01-04, SH IE 150 Scoopy 150 4T 05-12, Silver Wing 150 [FES] 150 4T-2V 07-12

Keeway Outlook 125 125 4T 07-08, Outlook 150 150 4T 07-08

cod. 9926780

Molla contrasto variatore colore bianco per Piaggio 500 cc (carico 78 kg)

APPLICABILITÀ

Aprilia Atlantic Arrecife 400 400 4T -00, Atlantic Sprint 400 400 4T 05-08, Scarabeo Light 400 400 4T 06-08, Atlantic 500 500 4T 01-04, Atlantic Arrecife 500 500 4T 05-08, Atlantic Sprint 500 500 4T 05-08, Scarabeo 500 500 4T 03-06, Scarabeo Light 500 500 4T 06-08

Gilera Nexus 500 500 4T 03-05

Malaguti Spider Max 500 GT 500 4T 04-05, Spider Max 500 GT EU3 500 4T 06-06, Spider Max RS 500 500 4T 08-08

Peugeot Geopolis 400 IE EU3 400 4T-4V -00, Satelis 400 EU3 400 4T -00, Geopolis 500 IE EU3 500 4T-4V -00, Satelis 500 EU3 500 4T -00

Piaggio Beverly 400 EU3 400 4T 06-07, Beverly Tourer 400 EU3 400 4T 08-10, MP3 400 400 4T 07-08, MP3 400 IE LT Touring 400 4T 11-11, MP3 400 IE LT/Sport 400 4T 08-10, MP3 400 MIC 400 4T 08-10, MP3 400 RL Touring 400 4T 11-11, X-Evo 400 400 4T 07-11, X8 400 EU3 400 4T 06-08, Beverly 500 500 4T 02-06, Beverly 500 ie EU3 500 4T 06-08, Beverly Cruiser 500 500 4T 07-11, MP3 500 LT Sport/Business 500 4T -, MP3 500 RL Sport 500 4T -, X9 500 500 4T 01-02, X9 Evolution 500 500 4T 03-07, X9 Evolution ABS 500 500 4T 06-07

cod. 9926790

Molla contrasto variatore colore bianco per Suzuki Burgman 400 cc (carico 67 kg)

APPLICABILITÀ

Suzuki AN Burgman 400 K3/K6 400 4T 03-06, AN Burgman 400 K7/L0 400 4T 07-10

cod. 9926800

Molla contrasto variatore colore bianco per Honda Forsight 250 cc (carico 59 kg)

APPLICABILITÀ

Honda Foresight 250 [FES] D.D. 250 4T 00-05, Forza 250 [NSS] 250 4T-2V 02-07, Forza X 250 [NSS] 250 4T-2V 05-07, Jazz 250 ES Reflex [NSS] 250 4T-2V 01-04, Jazz 250 Reflex [NSS] 250 4T-2V 01-01

cod. 9929170

Molla contrasto variatore colore bianco per Yamaha Majesty 125/150 cc (carico 39 kg)

APPLICABILITÀ

Benelli Velvet 125 125 4T 99-01, Velvet 150 150 4T 99-01

Italjet Jupiter 125 125 4T -00, Millenium 125 125 4T -00, Jupiter 150 150 4T -00, Millenium 150 150 4T -00

Malaguti Madison 125 125 4T 99-01, Madison R Restyling 125 125 4T 02-02, Madison R Restyling 125 EU2 125 4T 03-04, Phantom Max 125 125 4T 03-03, Madison T 150 150 4T 99-01

Mbk Doodo 125 125 4T 00-00, Skyliner 125 125 4T 98-02, Skyliner E 125 125 4T 03-03, Thunder 125 125 4T 01-02, Doodo 150 150 4T 01-02, Skyliner 150 150 4T 00-02, Thunder 150 150 4T 01-02

Yamaha Majesty 125 125 4T 98-02, Majesty 125 E 125 4T 03-09, Maxter 125 125 4T 01-02, Teo's 125 125 4T 00-00, Majesty 150 150 4T 00-02, Maxter 150 150 4T 01-02, Teo's 150 150 4T 01-02



◀ **cod. 9929870**

Molla contrasto variatore colore giallo per Yamaha X-Max 250 cc (carico 56 kg)

APPLICABILITÀ

Aprilia	Leonardo 250 250 4T 99-04, Leonardo 250 ST 250 4T 01-01	Mbk	Skyliner 250 250 4T 00-03, Skyliner 250 ABS 250 4T 03-03
Benelli	Velvet 250 250 4T 99-03	Yamaha	Majesty 250 250 4T 96-03, Majesty 250 ABS 250 4T 03-03, Majesty 250 DX 250 4T 98-99, X-City 250 250 4T 07-12, X-Max 250 250 4T 05-12
Italjet	Jupiter 250 250 4T 00-00		
Malaguti	Madison S 250 250 4T 99-01, Password 250 250 4T 05-06, Password 250 EU3 250 4T 07-08		

◀ **cod. 9929880**

Molla contrasto variatore colore giallo per Yamaha T-Max 500 cc (carico 93,5 kg)

APPLICABILITÀ

Yamaha	T-Max 4BS 500 500 4T 09-11, T-Max 4BS ABS 500 500 4T 08-11, T-Max 5GJ 500 500 4T 01-03, T-Max 5VU 500 500 4T 04-08, T-Max 5VU ABS 500 500 4T 05-07, T-Max 5VU BLACK MAX 500 4T 06-06, T-Max 5VU BLACK MAX - NIGHT MAX 500 4T 07-07, T-Max 59C 530 530 4T 12-16, T-Max 59C 530 ABS 530 4T 12-16, T-Max 59C 530 SP 530 4T 15-15, T-Max 59C 530 SP ABS 530 4T 15-16
---------------	--

◀ **cod. 9929890**

Molla contrasto variatore colore giallo per Honda SH 300 cc (carico 68 kg)

APPLICABILITÀ

Honda	SH IE 300 Scoopy 300 4T-4V 07-16
--------------	----------------------------------

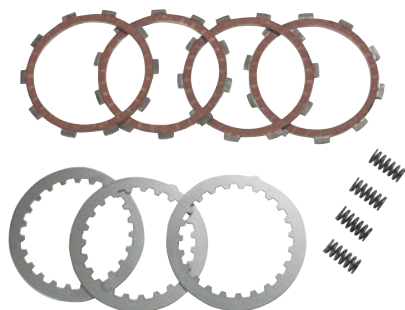

◀ cod. **9920250**
Serie dischi frizione AM 345/6

APPLICABILITÀ

Aprilia	Classic 50 2T 92-99, Europa 50 2T 91-92, MX 50 50 2T 04-04, MX 50 Motard 50 2T 95-03, Pegaso 50 2T 92-94, RS 50 50 2T 91-05, RX 50 50 2T 03-04, RX 50 3-5 Marce 50 2T 91-94, RX 50 Enduro 50 2T 95-03, RX 50 Racing 50 2T 03-06, Tuono 50 50 2T 03-04
Beta	RR Alu 50 2T 00-, RR Enduro 50 50 2T 00-, RR Motard 50 50 2T 00
CH Husqvarna	SM 50 50 2T -00, WR 50 50 2T -00, WSM 50 50 2T -00
CMC	Enduro 50 50 2T 11-11, Motard 50 50 2T 11-11
Fantic	Caballero Motard 50 2T 06-10, Caballero Regolarità 50 2T 06-10
HM	Baja, Derapage Basic 50 2T 10-11, CMC 50 2T 10-11, CRE Baja RR, Derapage RR 50 2T 07-11, CRE Baja, Derapage 50 2T 07-11, CRE Six Competition 50 2T 10-11, CRE Six, Baia, Derapage 50 2T 95-06, CRE Six, Derapage Competition 50 2T 07-09, Derapage Competition 50 2T 10-11

Malaguti	CNK Drakon 50 2T 05-07, Fifty Evolution 50 2T 90-93, XSM 50 50 2T -00, XTM 50 50 2T -00
Mbk	X Limit 50 2T -00, X Power 50 2T -00
Minarelli	AM 345 Motori Minarelli 50 2T -00
Motor Hispania	Furia 50 50 2T -00, Furia Max 50 50 2T -00, RX 50 50 2T -00, RX 50 R 50 2T -00
Peugeot	Supermotard 50 2T -00, XP6 Trail S/Avv. Elettrico 50 2T -00, XR6 Racing Cat. C/avv.elett. 50 2T -00
Rieju	MRT 50 50 2T -00, MRT 50 PRO 50 2T -00, MRT 50 PRO SM 50 2T -00, MRT 50 SM 50 2T -00, MRX 50 50 2T -00, MRX 50 PRO 50 2T -00, RR 50 50 2T -00, RS1 50 50 2T -00, RS2 50 Matrix 50 2T -00, RS2 50 Matrix Pro 50 2T -00, RS2 Naked 50 50 2T -00, SMX 50 E.S./K.S. 50 2T -00, SMX 50 PRO E.S./K.S. 50 2T -00, Spike 50 50 2T -00
Sherco	HRD Enduro 50 50 2T -00, HRD Motard 50 50 2T -00
Yamaha	DT R 50 2T 03-10, DT RSM 50 2T 03-05, DT X 50 2T 06-10, TZR 50 2T 03-08, TZR 50 2T 10-11, TZR RR 50 2T 05-05

RICAMBI

9920580	Serie molle frizione AM rinforzate 100 kg
---------	---

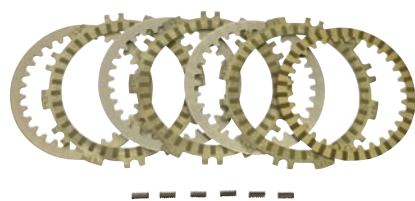

◀ cod. **9931020**
Serie dischi frizione con molle Piaggio

APPLICABILITÀ

Piaggio	Beverly 350 4T 4V IE EU3 350 4T 11-13
----------------	---------------------------------------

◀ cod. **9918550** **RACING**
Frizione a denti dritti Z=18/68 per motori Minarelli AM

NB: Montando questa coppia frizione è indispensabile eliminare il miscelatore automatico ed il contagiri meccanico.

APPLICABILITÀ

Aprilia	Classic 50 2T 92-99, Europa 50 2T 91-92, MX 50 50 2T 04-04, MX 50 Motard 50 2T 95-03, Pegaso 50 2T 92-94, RS 50 50 2T 91-05, RX 50 50 2T 03-04, RX 50 3-5 Marce 50 2T 91-94, RX 50 Enduro 50 2T 95-03, RX 50 Racing 50 2T 03-06, Tuono 50 50 2T 03-04
Beta	RR Alu 50 2T 00-, RR Enduro 50 50 2T 00-, RR Motard 50 50 2T 00
CH Husqvarna	SM 50 50 2T -00, WR 50 50 2T -00, WSM 50 50 2T -00
CMC	Enduro 50 50 2T 11-11, Motard 50 50 2T 11-11
Fantic	Caballero Motard 50 2T 06-10, Caballero Regolarità 50 2T 06-10
HM	Baja, Derapage Basic 50 2T 10-11, CMC 50 2T 10-11, CRE Baja RR, Derapage RR 50 2T 07-11, CRE Baja, Derapage 50 2T 07-11, CRE Six Competition 50 2T 10-11, CRE Six, Baia, Derapage 50 2T 95-06, CRE Six, Derapage Competition 50 2T 07-09, Derapage Competition 50 2T 10-11

Malaguti	CNK Drakon 50 2T 05-07, Fifty Evolution 50 2T 90-93, XSM 50 50 2T -00, XTM 50 50 2T -00
Mbk	X Limit 50 2T -00, X Power 50 2T -00
Minarelli	AM 345 Motori Minarelli 50 2T -00
Motor Hispania	Furia 50 50 2T -00, Furia Max 50 50 2T -00, RX 50 50 2T -00, RX 50 R 50 2T -00
Peugeot	Supermotard 50 2T -00, XP6 Trail S/Avv. Elettrico 50 2T -00, XR6 Racing Cat. C/avv.elett. 50 2T -00
Rieju	MRT 50 50 2T -00, MRT 50 PRO 50 2T -00, MRT 50 PRO SM 50 2T -00, MRT 50 SM 50 2T -00, MRX 50 50 2T -00, MRX 50 PRO 50 2T -00, RR 50 50 2T -00, RS1 50 50 2T -00, RS2 50 Matrix 50 2T -00, RS2 50 Matrix Pro 50 2T -00, RS2 Naked 50 50 2T -00, SMX 50 E.S./K.S. 50 2T -00, SMX 50 PRO E.S./K.S. 50 2T -00, Spike 50 50 2T -00
Sherco	HRD Enduro 50 50 2T -00, HRD Motard 50 50 2T -00
Yamaha	DT R 50 2T 03-10, DT RSM 50 2T 03-05, DT X 50 2T 06-10, TZR 50 2T 03-08, TZR 50 2T 10-11, TZR RR 50 2T 05-05

RICAMBI

9918510	Ingranaggio pompa acqua condotto Z=30
9920580	Serie molle frizione am rinforz. 100 Kg.

◀ cod. **9921180** **RACING**
Serie dischi frizione AM cellulosa/kevlar per motori Minarelli AM

APPLICABILITÀ

Aprilia	Classic 50 2T 92-99, Europa 50 2T 91-92, MX 50 50 2T 04-04, MX 50 Motard 50 2T 95-03, Pegaso 50 2T 92-94, RS 50 50 2T 91-05, RX 50 50 2T 03-04, RX 50 3-5 Marce 50 2T 91-94, RX 50 Enduro 50 2T 95-03, RX 50 Racing 50 2T 03-06, Tuono 50 50 2T 03-04
Beta	RR Alu 50 2T 00-, RR Enduro 50 50 2T 00-, RR Motard 50 50 2T 00
CH Husqvarna	SM 50 50 2T -00, WR 50 50 2T -00, WSM 50 50 2T -00
CMC	Enduro 50 50 2T 11-11, Motard 50 50 2T 11-11
Fantic	Caballero Motard 50 2T 06-10, Caballero Regolarità 50 2T 06-10
HM	Baja, Derapage Basic 50 2T 10-11, CMC 50 2T 10-11, CRE Baja RR, Derapage RR 50 2T 07-11, CRE Baja, Derapage 50 2T 07-11, CRE Six Competition 50 2T 10-11, CRE Six, Baia, Derapage 50 2T 95-06, CRE Six, Derapage Competition 50 2T 07-09, Derapage Competition 50 2T 10-11

Malaguti	CNK Drakon 50 2T 05-07, Fifty Evolution 50 2T 90-93, XSM 50 50 2T -00, XTM 50 50 2T -00
Mbk	X Limit 50 2T -00, X Power 50 2T -00
Minarelli	AM 345 Motori Minarelli 50 2T -00
Motor Hispania	Furia 50 50 2T -00, Furia Max 50 50 2T -00, RX 50 50 2T -00, RX 50 R 50 2T -00
Peugeot	Supermotard 50 2T -00, XP6 Trail S/Avv. Elettrico 50 2T -00, XR6 Racing Cat. C/avv.elett. 50 2T -00
Rieju	MRT 50 50 2T -00, MRT 50 PRO 50 2T -00, MRT 50 PRO SM 50 2T -00, MRT 50 SM 50 2T -00, MRX 50 50 2T -00, MRX 50 PRO 50 2T -00, RR 50 50 2T -00, RS1 50 50 2T -00, RS2 50 Matrix 50 2T -00, RS2 50 Matrix Pro 50 2T -00, RS2 Naked 50 50 2T -00, SMX 50 E.S./K.S. 50 2T -00, SMX 50 PRO E.S./K.S. 50 2T -00, Spike 50 50 2T -00
Sherco	HRD Enduro 50 50 2T -00, HRD Motard 50 50 2T -00
Yamaha	DT R 50 2T 03-10, DT RSM 50 2T 03-05, DT X 50 2T 06-10, TZR 50 2T 03-08, TZR 50 2T 10-11, TZR RR 50 2T 05-05

RICAMBI

9920580	Serie molle frizione AM rinforzate 100 KG
---------	---





cod. **9923190** **RACING**
Serie dischi frizione cellulosa/kevlar Derbi

APPLICABILITÀ

Aprilia RS 50 50 2T 06-10, RS4 50 2T 11-13, RX 50 50 2T 06-, SX 50 2T 06-10, SX 50 50 2T

Derbi Bultaco Lobito 50 2T 98-01, GPR 2T EU2 50 2T 09-10, GPR NUDE 50 2T 04-05, GPR NUDE & GPR NUDE Tuning 50 2T 06-08, GPR NUDE Sport 50 2T 06-06, GPR R 50 2T 97-00, GPR R EU2 - GPR Replica EU2 50 2T 08-08, GPR Racing 50 2T 04-05, GPR Racing EU2 50 2T 06-06, GPR Replica 50 2T 99-01, GPR Replica & GPR R EU2 50 2T 06-06, GPR Replica 2T Malossi 50 2T 07-07, GPR Replica Pesek EU2 50 2T 07-07, GPR Replica Racing 50 2T 02-03, GPR Replica Racing EU2 50 2T 05-05, Sebba R Racer 50 2T 03-03, Senda Black Edition 50 2T 03-03, Senda HYP DRD Evo EU2 50 2T 08-09, Senda HYP DRD Evo Limited Edition EU2 50 2T 08-08, Senda R 50 2T 99-01, Senda R DRD EU1 EU1R 50 2T 02-02, Senda R DRD PRO EU2 50 2T 05-11, Senda R DRD Racing 50 2T 04-05, Senda R DRD Racing EU2 50 2T 05-08, Senda R DRD Racing LTD 50 2T 05-05, Senda R X-RACE 50 2T 04-05,

Senda R X-RACE 2T EU2 50 2T 10-10, Senda R X-RACE EU2 50 2T 06-09, Senda R X-TREME 50 2T 03-03, Senda R X-TREME 50 2T 05-05, Senda R X-TREME 2T EU2 50 2T -, Senda R X-TREME EU2 50 2T 04-08, Senda SM 50 2T 00-01, Senda SM DRD EU1 EU1R 50 2T 02-03, Senda SM DRD Edition Black 50 2T 05-05, Senda SM DRD PRO EU2 50 2T 05-11, Senda SM DRD Racing 50 2T 04-05, Senda SM DRD Racing EU2 50 2T 05-08, Senda SM DRD Racing LTD 50 2T 05-05, Senda SM DRD Racing LTD EU2 50 2T 07-07, Senda SM X-RACE 50 2T 04-05, Senda SM X-RACE 2T EU2 50 2T 10-10, Senda SM X-RACE EU2 50 2T 06-09, Senda SM X-TREME 50 2T 02-03, Senda SM X-TREME 2T EU2 50 2T 10-10, Senda SM X-TREME EU2 50 2T 04-08

Gilera Gsm H@K 50 2T 01-01, RCR 50 2T 03-03, RCR 50 2T 06-07, RCR 50 2T 11-12, SMT 50 2T 03-, SMT Racing 50 2T 11-12

RICAMBI

9923180 Serie molle frizione rinforzate per Derbi

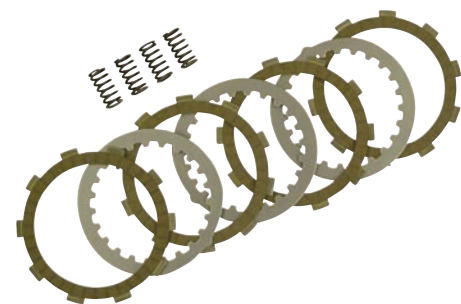

cod. **9930850** **RACING**
Serie dischi frizione TPR per AM 345/6

APPLICABILITÀ

Aprilia Classic 50 2T 92-99, Europa 50 2T 91-92, MX 50 50 2T 04-04, MX 50 Motard 50 2T 95-03, Pegaso 50 2T 92-94, RS 50 50 2T 91-05, RX 50 50 2T 03-04, RX 50 3-5 Marce 50 2T 91-94, RX 50 Enduro 50 2T 95-03, RX 50 Racing 50 2T 03-06, Tuono 50 50 2T 03-04

Beta RR Alu 50 2T 00-, RR Enduro 50 50 2T 00-, RR Motard 50 50 2T 00

CH Husqvarna SM 50 50 2T -00, WR 50 50 2T -00, WSM 50 50 2T -00

CMC Enduro 50 50 2T 11-11, Motard 50 50 2T 11-11

Fantic Caballero Motard 50 2T 06-10, Caballero Regolarità 50 2T 06-10

HM Baja, Derapage Basic 50 2T 10-11, CMC 50 2T 10-11, CRE Baja RR, Derapage RR 50 2T 07-11, CRE Baja, Derapage 50 2T 07-11, CRE Six Competition 50 2T 10-11, CRE Six, Baia, Derapage 50 2T 95-06, CRE Six, Derapage Competition 50 2T 07-09, Derapage Competition 50 2T 10-11

Malaguti CNK Drakon 50 2T 05-07, Fifty Evolution 50 2T 90-93, XSM 50 50 2T -00, XTM 50 50 2T -00

Mbk X Limit 50 2T -00, X Power 50 2T -00

Minarelli AM 345 Motori Minarelli 50 2T -00

Motor Hispania Furia 50 50 2T -00, Furia Max 50 50 2T -00, RX 50 50 2T -00, RX R 50 50 2T -00

Peugeot Supermotard 50 2T -00, XP6 Trail S/Avv. Elettrico 50 2T -00, XR6 Racing Cat. C/avv.elett. 50 2T -00

Rieju MRT 50 50 2T -00, MRT 50 PRO 50 2T -00, MRT 50 PRO SM 50 2T -00, MRT 50 SM 50 2T -00, MRX 50 50 2T -00, MRX 50 PRO 50 2T -00, RR 50 50 2T -00, RS1 50 50 2T -00, RS2 50 Matrix 50 2T -00, RS2 50 Matrix Pro 50 2T -00, RS2 Naked 50 50 2T -00, SMX 50 E.S./K.S. 50 2T -00, SMX 50 PRO E.S./K.S. 50 2T -00, Spike 50 50 2T -00

Sherco HRD Enduro 50 50 2T -00, HRD Motard 50 50 2T -00

Yamaha DT R 50 2T 03-10, DT RSM 50 2T 03-05, DT X 50 2T 06-10, TZR 50 2T 03-08, TZR 50 2T 10-11, TZR RR 50 2T 05-05

A RICAMBIO PER

9931900 Kit frizione completo Tamburo+dischi tpr per am 345/6

RICAMBI

9920580 Serie molle frizione AM rinforzate 100 kg

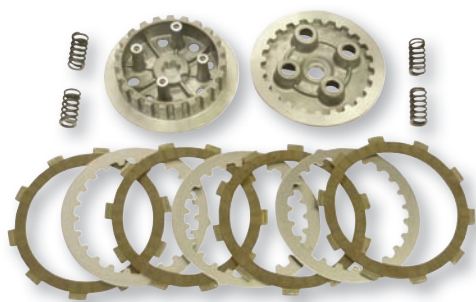

cod. **9931900** **RACING**
Kit frizione completa tamburo e dischi "TPR" per AM 345/6

APPLICABILITÀ

Aprilia Classic 50 2T 92-99, Europa 50 2T 91-92, MX 50 50 2T 04-04, MX 50 Motard 50 2T 95-03, Pegaso 50 2T 92-94, RS 50 50 2T 91-05, RX 50 50 2T 03-04, RX 50 3-5 Marce 50 2T 91-94, RX 50 Enduro 50 2T 95-03, RX 50 Racing 50 2T 03-06, Tuono 50 50 2T 03-04

Beta RR Alu 50 2T 00-, RR Enduro 50 50 2T 00-, RR Motard 50 50 2T 00

CH Husqvarna SM 50 50 2T -00, WR 50 50 2T -00, WSM 50 50 2T -00

CMC Enduro 50 50 2T 11-11, Motard 50 50 2T 11-11

Fantic Caballero Motard 50 2T 06-10, Caballero Regolarità 50 2T 06-10

HM Baja, Derapage Basic 50 2T 10-11, CMC 50 2T 10-11, CRE Baja RR, Derapage RR 50 2T 07-11, CRE Baja, Derapage 50 2T 07-11, CRE Six Competition 50 2T 10-11, CRE Six, Baia, Derapage 50 2T 95-06, CRE Six, Derapage Competition 50 2T 07-09, Derapage Competition 50 2T 10-11

Malaguti CNK Drakon 50 2T 05-07, Fifty Evolution 50 2T 90-93, XSM 50 50 2T -00, XTM 50 50 2T -00

Mbk X Limit 50 2T -00, X Power 50 2T -00

Minarelli AM 345 Motori Minarelli 50 2T -00

Motorhispania Furia 50 50 2T -00, Furia Max 50 50 2T -00, RX 50 50 2T -00, RX R 50 50 2T -00

Peugeot Supermotard 50 2T -00, XP6 Trail S/Avv. Elettrico 50 2T -00, XR6 Racing Cat. C/avv.elett. 50 2T -00

Rieju MRT 50 50 2T -00, MRT 50 PRO 50 2T -00, MRT 50 PRO SM 50 2T -00, MRT 50 SM 50 2T -00, MRX 50 50 2T -00, MRX 50 PRO 50 2T -00, RR 50 50 2T -00, RS1 50 50 2T -00, RS2 50 Matrix 50 2T -00, RS2 50 Matrix Pro 50 2T -00, RS2 Naked 50 50 2T -00, SMX 50 E.S./K.S. 50 2T -00, SMX 50 PRO E.S./K.S. 50 2T -00, Spike 50 50 2T -00

Sherco HRD Enduro 50 50 2T -00, HRD Motard 50 50 2T -00

Yamaha DT R 50 2T 03-10, DT RSM 50 2T 03-05, DT X 50 2T 06-10, TZR 50 2T 03-08, TZR 50 2T 10-11, TZR RR 50 2T 05-05

RICAMBI

9920580 Serie Molle Frizione Am Rinforz.100 Kg.

9930850 Serie Dischi Friz.Tpr Per Am345/6



◀ **cod. 9927810**
Serie molle frizione rinforzate WR 125 (carico 31,5 kg)

APPLICABILITÀ

Beta RR 125 4T-4V 10-10

Fantic Caballero Motard 125 4T-4V 08-08, Caballero Regularità 125 4T-4V 08-08

HM City 125 4T-4V 11-13, Cre F125x 125 4T-4V 08-09, Cre F125x Baja 125 4T-4V 10-12, Cre F125x Baja Rr 125 4T-4V 10-12, Cre F125x Six 125 4T-4V 10-11, Crm F125x 125 4T-4V 08-09, Crm F125x Derapage 125 4T-4V 10-12, Crm F125x Derapage Competition 125 4T-4V 10-11, Crm F125x Derapage Rr 125 4T-4V 10-12, Locusta 125 4T-4V 11-13, City 200 4T-4V 11-13, Locusta 200 4T-4V 11-13

Husqvarna SM 125 4T-4V 10-10, TE 125 4T-4V 10-10

Motor Hispania KN1 125 4T-4V 08-08, MH7 125 4T-4V 08-08, RX-R 125 4T-4V 08-08

Rieju Marathon 125 4T-4V 09-09, Marathon Pro 125 4T-4V 09-09, Marathon Pro Competition 125 4T-4V 11-11, RS3 125 4T-4V 11-11

Yamaha Mt 125 125 4T 4V le 15-15, Mt 125 A 125 4T 4V le 15-15, Wt-R le 125 4T 4V le 09-11, Wt-X le 125 4T 4V le 09-11, Wt-X le 125 4T 4V le 13-14, Yzf-R A le 125 4T 4V le 15-15, Yzf-R le 125 4T 4V le 08-15

KIT FRIZIONE



◀ **cod. 9928150** **RACING**
Serie dischi frizione con molle Racing Yamaha T-Max

APPLICABILITÀ

Yamaha T-Max 4BS 500 500 4T 09-11, T-Max 4BS ABS 500 500 4T 08-11, T-Max 5GJ 500 500 4T 01-03, T-Max 5VU 500 500 4T 04-08, T-Max 5VU ABS 500 500 4T 05-07, T-Max 5VU BLACK MAX 500 4T 06-06, T-Max 5VU BLACK MAX - NIGHT MAX 500 4T 07-07

RICAMBI

9927930 Serie molle frizione carico differenziato Yamaha T-Max



◀ **cod. 9930880** **RACING**
Serie dischi frizione con molle Racing Yamaha T-Max 530

APPLICABILITÀ

Yamaha T-Max 59C 530 530 4T 12-16, T-Max 59C 530 ABS 530 4T 12-16, T-Max 59C 530 SP 530 4T 15-15, T-Max 59C 530 SP ABS 530 4T 15-16

RICAMBI

9930890 Serie molle frizione



◀ **cod. 9910020**
Frizione alleggerita per tutti i motori scooter 50 cc. Minarelli, Yamaha, Piaggio, Gilera, Derbi, Peugeot, Honda, con campana Ø interno 107 mm

APPLICABILITÀ

Aprilia Amico 50 2T 94-94, Amico 50 2T 96-98, Amico GL/GLE 50 2T 93-95, Amico LX/Sport/Cat 50 2T 92-93, Area 51 50 2T 98-00, Gulliver 50 2T 95-98, Gulliver LC 50 2T 96-98, Mojito 50 2T -, Rally 50 2T 95-03, Rally Liquid Cooled 50 2T 96-99, SR (Orizzontale) 50 2T 94-96, SR (Verticale) 50 2T 93-93, SR Liquid Cooled 50 2T 94-96, SR R 50 2T 04-09, SR R FACTORY Carburatore 50 2T -, SR R FACTORY IE 50 2T -, SR RACING 50 2T 97-99, SR Stealth 50 2T 97-99, SR Street Carburatore 50 2T 03-12, SR WWW 50 2T 97-01, Scarabeo 50 2T 93-05, Scarabeo 2T EU2 Motore Piaggio 50 2T 10-12, Scarabeo 2T Net 50 2T 09-10, Scarabeo 4T 50 4T 02-06, Scarabeo 4T 4V 50 4T-4V 10-12, Scarabeo 4T 4V NET 50 4T-4V 09-10, Scarabeo 4T Restyling EU3 50 4T 06-09, Scarabeo Quattro 50 4T-4V 09-09, Scarabeo Street 50 2T 05-06, Scarabeo Street 2T Restyling 50 2T 06-09, Sonic 50 2T 98-07, Sonic GP 50 2T 98-08, Sport City One 50 2T 08-11, Sport City One 4T 50 4T 08-10

Atala Carosello 50 2T -00

BSV Dio GP 50 2T -00, Dio SP 50 2T -00, Dio ZX 50 2T -00

Benelli 491 GT 50 2T 98-99, 491 RR 50 2T 99-01, 491 Racing 50 2T 98-99, 491 SP 50 2T 99-99, 491 ST 50 2T 99-01, 491 Sport 50 2T 98-99, K2 50 2T 98-01, K2 Liquid Cooled 50 2T 98-01, Naked 50 2T 02-02, Pepe 50 2T 99-01, Pepe LX 50 2T 03-04

Beta Ark 50 2T 96-08, Ark LC 50 2T 96-08, Chrono 50 2T 96-00, Eikon 50 2T 99-03, Quadra 50 2T 95-00, Tempo 50 2T 95-00

Derbi Atlantis 2T 50 2T 10-10, Atlantis 2T EU2 50 2T 07-09, Atlantis O2 50 2T 02-02, Atlantis O2 Bullet 50 2T 03-05, Atlantis O2 City 50 2T 03-06, Atlantis O2 Red Bullet 50 2T 03-03, Atlantis O2 Two Chic 50 2T 05-05, Boulevard 50 2T 09-12, GP1 50 2T 01-03, GP1 EU2 50 2T 05-05, GP1 Open EU2 50 2T 06-09, GP1 Race EU2 50 2T 05-07, Sonar 2T 50 2T 09-09

Gilera DNA 50 2T 00-02, DNA 50 2T 05-07, DNA GP Experience 50 2T 03-04, Easy Moving 50 2T 95-96, Ice 50 2T 01-05, Runner 50 2T 97-00, Runner Poggiali 50 2T 02-02, Runner SP 50 2T 02-07, Runner SP 50 2T 10-12, Runner SP ST & Simoncelli 50 2T 08-09, Runner SP Special Edition 50 2T 07-07, Stalker 50 2T 97-11, Stalker Naked 50 2T 08-08, Stalker Special Edition 50 2T 07-08, Storm 50 2T 94-95, Storm Euro 2 50 2T 07-07, Typhoon 50 2T 94-97, Typhoon X 50 2T 98-99

HSC SC 01 50 2T -00, SC 01 L 50 2T -00

Honda Bali 50 2T 93-99, Dio ZX 50 2T -00, SFX / SXR 50 2T -, SGX SKY 50 2T -, SH New 50 2T 96-01

Italjet Bazooka 50 2T -00, Dragster 50 2T -00, Jet Set 50 2T -00, Pista 50 2T -00, Pista 2 50 2T -00, Scoop 50 2T -00, Scoop 2 50 2T -00, Torpedo New 50 2T -00, Yankee 50 2T -00

KTM K50 50 2T -00

Kymco Agility R12 50 4T 05-05

Macal Thunder 50 2T -00

Malaguti Centro 50 2T -00, Ciak 50 2T -00, Ciak Euro 2,3 50 2T 03-03, Ciak Euro 2.50 2T 01-03, F10 50 2T -00, F10 Euro 2 50 2T -00, F10 Euro 2.2 50 2T 03-04, F12 Phantom 50 2T -00, F12 Phantom Euro 2 50 2T 02-02, F12 Phantom Euro 2.2 50 2T 03-04, F12 Phantom LC 50 2T -00, F12 Phantom LC Euro 2,3 50 2T 03-04, F12 Restyling Euro 1 50 2T 99-02, F12 Restyling Euro 2 50 2T 06-06, F15 Firefox 50 2T -00, F15 Firefox Euro 2 50 2T 02-03, F15 Firefox Euro 2.2 50 2T 03-04, Yesterday 50 2T 97-00

Mbk Booster 50 2T -00, Booster Euro 2 50 2T 04-04, Booster NG 50 2T 03-00, Booster Rocket 50 2T 97-98, Booster Spirit 50 2T 03-00, Booster Track 50 2T 96-98, Flipper 50 2T -00, Flipper Euro 2 50 2T 03-03, Mach G 50 2T 02-04, Mach G LC 50 2T 02-04, Nitro 50 2T -00, Nitro Euro 2 50 2T 03-03, Ovetto 50 2T -00, Ovetto Euro 2 50 2T 02-02, Somiso 50 2T 95-96, Stunt 50 2T 00-02, Target 50 2T 91-95

Peugeot Buxy 50 2T -00, Buxy RS 50 2T -00, Elyseo 50 2T -00, Jet Force 50 2T -00, Looxor 50 2T -00, Metal X 50 2T -00, SV Geo 50 2T -00, Speedake 50 2T -00, Speedfight 50 2T -00, Squab 50 2T -00, Trekker 50 2T -00, Vvacity 50 2T -00, X-Fight 50 2T -00, Zenith 50 2T -00

Piaggio Diesis 50 2T 01-01, Fly 2T 50 2T 05-07, Fly 2T 50 2T 10-11, Fly 4T 50 4T 05-07, Fly 4T & 25-30 KM/H 50 4T 08-11, Fly 4T Motore CHN 50 4T 06-07, Free 50 2T 92-94, Free Delivery 50 2T 00-01, Liberty 50 2T 97-05, Liberty 2T 50 2T 06-08, Liberty 2T PTT EU2 50 2T 04-05, Liberty 2T RST 50 2T 04-04, Liberty 2T Sport 50 2T 06-08, Liberty 4T 50 4T 00-02, Liberty 4T 50 4T 05-08, Liberty 4T Delivery - Single 50 4T 10-12, Liberty 4T Delivery TNT 50 4T 09-09, Liberty 4T PTT - DOUBLE 50 4T 09-12, Liberty 4T RST 50 4T 04-04, Liberty 4T Sport 50 4T 06-08, Liberty MOC 2T & Elle 50 2T -, Liberty MOC 4T & Elle 50 4T 09-13, NRG 50 2T 94-96, NRG Power DT 50 2T 06-11, NRG Power DT Serie Speciale 50 2T 07-08, NRG RST MC2 50 2T 96-98, NTT 50 2T 95-96, Quartz 50 2T 92-96, Sfera 50 2T 91-93, Sfera Maquillage 2 50 2T 94-94, Sfera RST 50 2T 95-97, Typhoon 2T E2 50 2T 10-12, Typhoon 2T E3 CH 50 2T 11-11, Vespa ET2 50 2T 97-05, Vespa ET4 50 4T 00-05, Zip 50 2T 92-93, Zip 50 2T 95-96, Zip 4T 50 4T 00-13, Zip Bimodale 50 2T 94-97, Zip Fast Rider 50 2T 93-94, Zip Fast Rider RST 50 2T 96-97, Zip RST 50 2T 96-99, Zip Sp 50 2T 96-00

Rieju First 50 2T -00, Windy 50 2T -00

Yamaha Aerox 50 2T -00, Aerox Euro 2 50 2T 03-03, BWS 50 2T -00, BWS Bump 50 2T 97-98, BWS Euro 2 50 2T 03-03, BWS NG 50 2T -00, BWS NG Euro 2 50 2T 03-03, CRZ 50 2T 91-95, CT 50 2T 90-95, Jog R 50 2T 02-10, Jog R LC 50 2T -00, Neo's 50 2T -00, Neo's Euro 2 50 2T 02-02, Slider 50 2T 00-02, Spy 50 2T 95-98, Why 50 2T -00, Why Euro 2 50 2T 03-03, Zuma 50 2T 97-01



cod. 9911060

Frizione alleggerita per tutti i motori scooter 50 cc Minarelli/Yamaha, con campana Ø interno 105 mm

APPLICABILITÀ

Aprilia	Amico 50 2T 94-94, Amico 50 2T 96-98, Amico GL/GLE 50 2T 93-95, Amico LX/Sport/Cat 50 2T 92-93, Area 51 50 2T 98-00, Gulliver 50 2T 95-98, Gulliver LC 50 2T 96-98, Rally 50 2T 95-03, Rally Liquid Cooled 50 2T 96-99, SR (Orizzontale) 50 2T 94-96, SR (Verticale) 50 2T 93-93, SR Liquid Cooled 50 2T 94-96, SR Recing 50 2T 97-99, SR Stealth 50 2T 97-99, SR WWW 50 2T 97-01, Scarabeo 50 2T 93-05, Sonic 50 2T 98-07, Sonic GP 50 2T 98-08	Malaguti	Centro 50 2T -00, Ciak 50 2T -00, Ciak Euro 2,2,3 50 2T 03-03, Ciak Euro2 50 2T 01-03, F10 50 2T -00, F10 Euro 2 50 2T -00, F10 Euro 2,3 50 2T 03-04, F12 Phantom 50 2T -00, F12 Phantom Euro 2,3 50 2T 03-04, F12 Phantom LC 50 2T -00, F12 Phantom LC Euro 2,2,3 50 2T 03-04, F12 Restyling Euro 2 50 2T 06-06, F15 Firefox 50 2T -00, F15 Firefox Euro 2 50 2T 02-03, F15 Firefox Euro 2,3 50 2T 03-04, Yesterday 50 2T 97-00
Atala	Carosello 50 2T -00	Mbk	Booster 50 2T -00, Booster Euro 2 50 2T 04-04, Booster NG 50 2T 03-00, Booster Rocket 50 2T 97-98, Booster Spirit 50 2T 03-00, Booster Track 50 2T 96-98, Flipper 50 2T -00, Flipper Euro 2 50 2T 03-03, Mach G 50 2T 02-04, Mach G LC 50 2T 02-04, Nitro 50 2T -00, Nitro Euro 2 50 2T 03-03, Ovetto 50 2T -00, Ovetto Euro 2 50 2T 02-02, Sorriso 50 2T 95-96, Stunt 50 2T 00-02, Target 50 2T 91-95
Benelli	491 GT 50 2T 98-99, 491 RR 50 2T 99-01, 491 Racing 50 2T 98-99, 491 SP 50 2T 99-99, 491 ST 50 2T 99-01, 491 Sport 50 2T 98-99, K2 50 2T 98-01, K2 Liquid Cooled 50 2T 98-01, Naked 50 2T 02-02, Pepe 50 2T 99-01, Pepe LX 50 2T 03-04	Motron	Syncro 50 2T -00, Thunder 50 2T -00
Beta	Ark 50 2T 96-08, Ark LC 50 2T 96-08, Chrono 50 2T 96-00, Eikon 50 2T 99-03, Quadra 50 2T 95-00, Tempo 50 2T 95-00	Rieju	First 50 2T -00, Windy 50 2T -00
Italjet	Bazooka 50 2T -00, Dragster 50 2T -00, Pista 50 2T -00, Pista 2 50 2T -00, Scoop 50 2T -00, Scoop 2 50 2T -00, Yankee 50 2T -00	Yamaha	Aerox 50 2T -00, Aerox Euro 2 50 2T 03-03, BWS 50 2T -00, BWS Bump 50 2T 97-98, BWS Euro 2 50 2T 03-03, BWS NG 50 2T -00, BWS NG Euro 2 50 2T 03-03, CRZ 50 2T 91-95, CT 50 2T 90-95, Jog R 50 2T 02-10, Jog R LC 50 2T -00, Neo's 50 2T -00, Neo's Euro 2 50 2T 02-02, Slider 50 2T 00-02, Spy 50 2T 95-98, Why 50 2T -00, Why Euro 2 50 2T 03-03, Zuma 50 2T 97-01
KTM	K50 50 2T -00		
Macal	Thunder 50 2T -00		



cod. 9925130

Frizione con campana Ø interno 107 mm

APPLICABILITÀ

Aprilia	Amico 50 2T 94-94, Amico 50 2T 96-98, Amico GL/GLE 50 2T 93-95, Amico LX/Sport/Cat 50 2T 92-93, Area 51 50 2T 98-00, Gulliver 50 2T 95-98, Gulliver LC 50 2T 96-98, Rally 50 2T 95-03, Rally Liquid Cooled 50 2T 96-99, SR (Orizzontale) 50 2T 94-96, SR (Verticale) 50 2T 93-93, SR Liquid Cooled 50 2T 94-96, SR Recing 50 2T 97-99, SR Stealth 50 2T 97-99, SR WWW 50 2T 97-01, Scarabeo 50 2T 93-05, Sonic 50 2T 98-07, Sonic GP 50 2T 98-08	E-Ton	Viper RXL 50 2T -00	Mbk	Booster 50 2T -00, Booster Euro 2 50 2T 04-04, Booster NG 50 2T 03-00, Booster Rocket 50 2T 97-98, Booster Spirit 50 2T 03-00, Booster Track 50 2T 96-98, Booster X ie 50 4T-3V 08-08, Evolis 50 2T 92-95, Fizz 50 2T 94-95, Flipper 50 2T -00, Flipper Euro 2 50 2T 03-03, Forte 50 2T 94-96, Mach G 50 2T 02-04, Mach G LC 50 2T 02-04, Nitro 50 2T -00, Nitro Euro 2 50 2T 03-03, Ovetto 50 2T -00, Ovetto 4T 50 4T-3V 09-11, Ovetto Euro 2 50 2T 02-02, Sorriso 50 2T 95-96, Stunt 50 2T 00-02, Target 50 2T 91-95
Atala	Carosello 50 2T -00	Italjet	Dragster 50 2T -00	Motron	Syncro 50 2T -00, Thunder 50 2T -00
Benelli	491 GT 50 2T 98-99, 491 RR 50 2T 99-01, 491 Racing 50 2T 98-99, 491 SP 50 2T 99-99, 491 ST 50 2T 99-01, 491 Sport 50 2T 98-99, K2 50 2T 98-01, K2 Liquid Cooled 50 2T 98-01, Naked 50 2T 02-02, Pepe 50 2T 99-01, Pepe 50 2T 10-10, Pepe LX 50 2T 03-04, Pepe LX 50 2T 07-09, Pepe Old 50 2T 07-09, Pepe Old 50 2T 11-11, Quattronex 50 2T 08-11	KTM	K50 50 2T -00	Rieju	First 50 2T -00, Windy 50 2T -00
Beta	Ark 50 2T 96-08, Ark LC 50 2T 96-08, Chrono 50 2T 96-00, Eikon 50 2T 99-03, Quadra 50 2T 95-00, Tempo 50 2T 95-00	Keeway	ATV 50 EC2 50 2T 06-06, ATV OFF ROAD 50 2T 07-07, F-Act 50 2T 07-08, Flash 50 2T 07-08, Focus 50 2T 06-06, Goccia 50 2T 09-09, Hurricane 50 2T 06-08, Matrix 50 2T 06-08, Pixel Euro 2 50 2T -00, RY8 50 2T 08-08	Yamaha	Aerox 50 2T -00, Aerox Euro 2 50 2T 03-03, Axis 50 2T 95-96, BWS 50 2T -00, BWS Bump 50 2T 97-98, BWS Euro 2 50 2T 03-03, BWS NG 50 2T -00, BWS NG Euro 2 50 2T 03-03, CRZ 50 2T 91-95, CT 50 2T 90-95, Giggle 50 4T-3V 08-08, Jog 50 2T -00, Jog ER 50 2T -00, Jog R 50 2T 02-10, Jog R LC 50 2T -00, Jog Z 50 2T 95-95, Neo's 50 2T -00, Neo's 4 50 4T-3V 09-11, Neo's Euro 2 50 2T 02-02, Slider 50 2T 00-02, Spy 50 2T 95-98, Why 50 2T -00, Why Euro 2 50 2T 03-03, Zest 50 2T -00, Zuma 50 2T 97-01
CPI	Aragon 50 2T 03-03, Hussar 50 2T 03-03, Oliver 50 2T 03-03, Pop Corn 50 2T 03-03	Laverda	Quasar 50 2T -00		
Dinli	Helix DL603 50 2T -00, Helix DL603 90 50 2T -00, T-Rex 50 2T -00	Macal	Thunder 50 2T -00		
		Malaguti	Centro 50 2T -00, Ciak 50 2T -00, Ciak Euro 2,2,3 50 2T 03-03, Ciak Euro2 50 2T 01-03, Ciak Master Euro 2 50 2T 06-06, F10 50 2T -00, F10 Euro 2 50 2T -00, F10 Euro 2,2,3 50 2T 03-04, F10 Restyling Euro 2 50 2T 06-06, F10 Wap Euro 2 50 2T -00, F12 Phantom 50 2T -00, F12 Phantom Euro 2 50 2T 02-02, F12 Phantom Euro 2,2,3 50 2T 03-04, F12 Phantom LC 50 2T -00, F12 Phantom LC Euro 2,2,3 50 2T 03-04, F12 R Phantom 50 2T 07-07, F12 R Phantom LC 50 2T 07-09, F12 Restyling Euro 1 50 2T 99-02, F12 Restyling Euro 2 50 2T 06-06, F12 Restyling LC Euro 2 50 2T 06-06, F15 Firefox 50 2T -00, F15 Firefox Euro 2 50 2T 02-06, F15 Firefox Euro 2,2,3 50 2T 03-04, Yesterday 50 2T 97-00		



◀ cod. **9926630**

Frizione con campana Ø interno 107 mm, adattabile a tutti i motori scooter 50 cc. Gilera, Piaggio, Derbi.

APPLICABILITÀ

Aprilia	Mojito 50 2T -, SR R 50 2T 04-09, SR R FACTORY Carburatore 50 2T -, SR R FACTORY IE 50 2T -, SR Street Carburatore 50 2T 03-12, Scarabeo 2T EU2 Motore Piaggio 50 2T 10-12, Scarabeo 2T Net 50 2T 09-10, Scarabeo 4T 50 4T 02-06, Scarabeo 4T 4V 50 4T-4V 10-12, Scarabeo 4T 4V NET 50 4T-4V 09-10, Scarabeo 4T Restyling EU3 50 4T 06-09, Scarabeo Quattro 50 4T-4V 09-09, Scarabeo Street 50 2T 05-06, Scarabeo Street 2T Restyling 50 2T 06-09, Sport City One 2T 50 2T 08-11, Sport City One 4T 50 4T 08-10	HSC	SC 01 50 2T -00, SC 01 L 50 2T -00
BSV	Dio GP 50 2T -00, Dio SP 50 2T -00, Dio ZX 50 2T -00	Honda	Dio SR 50 2T 92-00, Dio ZX 50 2T -00, SFX / SXR 50 2T -, SGX SKY 50 2T
Derbi	Atlantis 2T 50 2T 10-10, Atlantis 2T EU2 50 2T 07-09, Atlantis O2 50 2T 02-02, Atlantis O2 Bullet 50 2T 03-05, Atlantis O2 City 50 2T 03-06, Atlantis O2 Red Bullet 50 2T 03-03, Atlantis O2 Two Chic 50 2T 05-05, Boulevard 50 2T 09-12, GP1 50 2T 01-03, GP1 EU2 50 2T 05-05, GP1 Open EU2 50 2T 06-09, GP1 Race EU2 50 2T 05-07, Sonar 2T 50 2T 09-09	Italjet	Jet Set 50 2T -00, Torpedo New 50 2T -00
Gilera	DNA 50 2T 00-02, DNA 50 2T 05-07, DNA GP Experience 50 2T 03-04, Easy Moving 50 2T 95-96, Ice 50 2T 01-05, Runner 50 2T 97-00, Runner Poggiali 50 2T 02-02, Runner Pure Jet 50 2T-IE 02-07, Runner Pure Jet 50 2T-IE 10-11, Runner Pure Jet ST 50 2T-IE 08-08, Runner SP 50 2T 02-07, Runner SP 50 2T 10-12, Runner SP ST & Simoncelli 50 2T 08-09, Runner SP Special Edition 50 2T 07-07, Stalker 50 2T 97-11, Stalker Naked 50 2T 08-08, Stalker Special Edition 50 2T 07-08, Storm 50 2T 94-95, Storm Euro 2 50 2T 07-07, Typhoon 50 2T 94-97, Typhoon X 50 2T 98-99, Typhoon XR 50 2T 00-00	Piaggio	Diesis 50 2T 01-01, Fly 2T 50 2T 05-07, Fly 2T 50 2T 10-11, Free 50 2T 92-94, Free Delivery 50 2T 00-01, Free FL 50 2T 95-02, Liberty 50 2T 97-05, Liberty 2T 50 2T 06-08, Liberty 2T PTT EU2 50 2T 04-05, Liberty 2T RST 50 2T 04-04, Liberty 2T Sport 50 2T 06-08, Liberty MOC 2T & Elle 50 2T -, NRG 50 2T 94-96, NRG Extreme 50 2T 99-00, NRG MC3 50 2T 01-04, NRG Power DD 50 2T 05-13, NRG Power DD Serie Speciale 50 2T -, NRG Power DT 50 2T 06-11, NRG Power DT Serie Speciale 50 2T 07-08, NRG Power Pure Jet 50 2T-IE 04-05, NRG Power PureJet 50 2T-IE 06-11, NRG PureJet 50 2T-IE 02-04, NRG PureJet 50 2T-IE 10-10, NRG RST MC2 50 2T 96-98, NTT 50 2T 95-96, Quartz 50 2T 92-96, Sfera 50 2T 91-93, Sfera Maquillage 2 50 2T 94-94, Sfera RST 50 2T 95-97, Typhoon 50 2T 01-11, Typhoon 2T E2 50 2T 10-12, Typhoon 2T E3 CH 50 2T 11-11, Vespa ET2 50 2T 97-05, Vespa ET2 iniezione 50 2T 97-00, Vespa LX 2T 50 2T 05-08, Vespa LX 2T FL 50 2T 09-10, Vespa LX 2T Touring 50 2T 10-11, Vespa LXV 2T 50 2T -, Vespa LXV 2T NAVY 50 2T 08-08, Vespa S 2T & College 50 2T 07-12, Zip 50 2T 92-93, Zip 50 2T 95-96, Zip 2T 50 2T -, Zip Bimodale 50 2T 94-97, Zip Fast Rider 50 2T 93-94, Zip Fast Rider RST 50 2T 96-97, Zip LC 50 2T 00-04, Zip RST 50 2T 96-99, Zip Sp 50 2T 96-04, Zip Sp Euro 2 50 2T

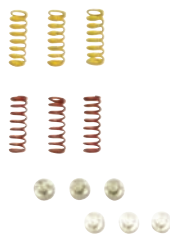

cod. **9928340**

RACING

Frizione completa regolabile TPR (GP) Ø 107 mm, scooter 50 cc Piaggio
N. BREVETTO 1413380

APPLICABILITÀ

- Aprilia** Mojito 50 2T -, SR R 50 2T 04-09, SR R FACTORY Carburatore 50 2T -, SR R FACTORY IE 50 2T-IE 10-12, SR R FACTORY IE 50 2T -, SR Street Carburatore 50 2T 03-12, Scarabeo 2T EU2 Motore Piaggio 50 2T 10-12, Scarabeo 2T Net 50 2T 09-10, Scarabeo 4T 50 4T 02-06, Scarabeo 4T 4V 50 4T-4V 10-12, Scarabeo 4T 4V NET 50 4T-4V 09-10, Scarabeo 4T Restyling EU3 50 4T 06-09, Scarabeo Quattro 50 4T-4V 09-09, Scarabeo Street 50 2T 05-06, Scarabeo Street 2T Restyling 50 2T 06-09, Sport City One 2T 50 2T 08-11, Sport City One 4T 50 4T 08-10
- Derbi** Atlantis 2T 50 2T 10-10, Atlantis 2T EU2 50 2T 07-09, Atlantis 4T 50 4T 04-06, Atlantis 4T EU2 50 4T 07-07, Atlantis O2 50 2T 02-02, Atlantis O2 Bullet 50 2T 03-05, Atlantis O2 City 50 2T 03-06, Atlantis O2 Red Bullet 50 2T 03-03, Atlantis O2 Two Chic 50 2T 05-05, Boulevard 50 2T 09-12, Boulevard 4T EU2 25KM/H 50 4T -, GP1 50 2T 01-03, GP1 EU2 50 2T 05-05, GP1 Open EU2 50 2T 06-09, GP1 Race EU2 50 2T 05-07, Sonar 2T 50 2T 09-09
- Gilera** DNA 50 2T 00-02, DNA 50 2T 05-07, DNA GP Experience 50 2T 03-04, Easy Moving 50 2T 95-96, Ice 50 2T 01-05, Runner 50 2T 97-00, Runner Poggiali 50 2T 02-02, Runner Pure Jet 50 2T-IE 02-07, Runner Pure Jet 50 2T-IE 10-11, Runner Pure Jet ST 50 2T-IE 08-08, Runner SP 50 2T 02-07, Runner SP 50 2T 10-12,

Runner SP ST & Simoncelli 50 2T 08-09, Runner SP Special Edition 50 2T 07-07, Stalker 50 2T 97-11, Stalker Naked 50 2T 08-08, Stalker Special Edition 50 2T 07-08, Storm 50 2T 94-95, Storm Euro 2 50 2T 07-07, Typhoon 50 2T 94-97, Typhoon X 50 2T 98-99, Typhoon XR 50 2T 00-00

Italjet

Malaguti

Piaggio

Centro Euro 2 50 4T 08-08, Centro SL 4T 50 4T 10-10, Ciak Master 4T 50 4T 05-06, Ciak Master Euro 2 50 4T 05-06

Diessis 50 2T 01-01, Fly 2T 50 2T 05-07, Fly 2T 50 2T 10-11, Fly 4T 50 4T 05-07, Fly 4T & 25-30 KM/H 50 4T 08-11, Fly 4T 50 4T-4V 12-12, Fly 4T Motore CHN 50 4T 06-07, Free 50 2T 92-94, Free Delivery 50 2T 00-01, Free FL 50 2T 95-02, Liberty 50 2T 97-05, Liberty 2T 50 2T 06-08, Liberty 2T PTT EU2 50 2T 04-05, Liberty 2T RST 50 2T 04-04, Liberty 2T Sport 50 2T 06-08, Liberty 4T 50 4T 00-02, Liberty 4T 50 4T 05-08, Liberty 4T Delivery - Single 50 4T 10-12, Liberty 4T Delivery TNT 50 4T 09-09, Liberty 4T PTT - DOUBLE 50 4T 09-12, Liberty 4T RST 50 4T 04-04, Liberty 4T Sport 50 4T 06-08, Liberty MOC 2T & Elle 50 2T -, Liberty MOC 4T & Elle 50 4T 09-13, NRG 50 2T 94-96, NRG Extreme 50 2T 99-00, NRG MC3 50 2T 01-04, NRG Power DD 50 2T 05-13, NRG Power DD Serie Speciale 50 2T -, NRG Power DT 50 2T 06-11, NRG Power DT Serie Speciale 50 2T 07-08, NRG Power Pure Jet 50 2T-IE 04-05,

NRG Power PureJet 50 2T-IE 06-11, NRG PureJet 50 2T-IE 02-04, NRG PureJet 50 2T-IE 10-10, NRG RST MC2 50 2T 96-98, NTT 50 2T 95-96, Quartz 50 2T 92-96, Sfera 50 2T 91-93, Sfera Maquillage 2 50 2T 94-94, Sfera RST 50 2T 95-97, Typhoon 50 2T 01-11, Typhoon 2T E2 50 2T 10-12, Typhoon 2T E3 CH 50 2T 11-11, Vespa ET2 50 2T 97-05, Vespa ET2 iniezione 50 2T 97-00, Vespa ET4 50 4T 00-05, Vespa LX 2T 50 2T 05-08, Vespa LX 2T FL 50 2T 09-10, Vespa LX 4T 4V 50 4T-4V 09-11, Vespa LX 4T 4V Touring 50 4T-4V 10-11, Vespa LXV 2T 50 2T -, Vespa LXV 2T NAVY 50 2T 08-08, Vespa S 2T & College 50 2T 07-12, Vespa S 4T 4V & College 50 4T-4V 08-11, Zip 50 2T 92-93, Zip 50 2T 95-96, Zip 2T 50 2T -, Zip 4T 50 4T 00-13, Zip Bimodale 50 2T 94-97, Zip Fast Rider 50 2T 93-94, Zip Fast Rider RST 50 2T 96-97, Zip LC 50 2T 00-04, Zip RST 50 2T 96-99, Zip Sp 50 2T 96-04, Zip Sp Euro 2 50 2T

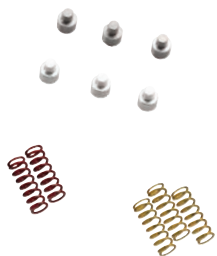

cod. **9927450**

RACING

Frizione completa regolabile TPR (GP) Ø 107 mm, scooter 50 cc Minarelli/Yamaha
N. BREVETTO 1413380

APPLICABILITÀ

- Aprilia** Amico 50 2T 94-94, Amico 50 2T 96-98, Amico GL/GLE 50 2T 93-95, Amico LX/Sport/Cat 50 2T 92-93, Area 51 50 2T 98-00, Gulliver 50 2T 95-98, Gulliver LC 50 2T 96-98, Rally 50 2T 95-03, Rally Liquid Cooled 50 2T 96-99, SR (Orizzontale) 50 2T 94-96, SR (Verticale) 50 2T 93-93, SR Liquid Cooled 50 2T 94-96, SR Racing 50 2T 97-99, SR Stealth 50 2T 97-99, SR WWW 50 2T 97-01, Scarabeo 50 2T 93-05, Sonic 50 2T 98-07, Sonic GP 50 2T 98-08
- Atala** Carosello 50 2T -00
- Benelli** 491 GT 50 2T 98-99, 491 RR 50 2T 99-01, 491 Racing 50 2T 98-99, 491 SP 50 2T 99-99, 491 ST 50 2T 99-01, 491 Sport 50 2T 98-99, K2 50 2T 98-01, K2 Liquid Cooled 50 2T 98-01, Naked 50 2T 02-02, Pepe 50 2T 99-01, Pepe LX 50 2T 03-04
- Beta** Ark 50 2T 96-08, Ark LC 50 2T 96-08, Chrono 50 2T 96-00, Eikon 50 2T 99-03, Quadra 50 2T 95-95, Tempo 50 2T 95-00

Italjet

KTM

Macal

Malaguti

Bazooka 50 2T -00, Dragster 50 2T -00, Pista 50 2T -00, Pista 2 50 2T -00, Scoop 50 2T -00, Scoop 2 50 2T -00, Yankee 50 2T -00

K50 50 2T -00

Thunder 50 2T -00

Centro 50 2T -00, Ciak 50 2T -00, Ciak Euro 2,3 50 2T 03-03, Ciak Euro 2,5 50 2T 01-03, F10 50 2T -00, F10 Euro 2 50 2T -00, F10 Euro 2,3 50 2T 03-04, F12 Phantom 50 2T -00, F12 Phantom Euro 2 50 2T 02-02, F12 Phantom Euro 2,3 50 2T 03-04, F12 Phantom LC 50 2T -00, F12 Phantom LC Euro 2,3 50 2T 03-04, F12 Restyling Euro 1 50 2T 99-02, F12 Restyling Euro 2 50 2T 06-06, F15 Firefox 50 2T -00, F15 Firefox Euro 2 50 2T 02-03, F15 Firefox Euro 2,3 50 2T 03-04, Yesterday 50 2T 97-00

Mbk

Motron

Rieju

Yamaha

Booster 50 2T -00, Booster Euro 2 50 2T 04-04, Booster NG 50 2T 03-00, Booster Rocket 50 2T 97-98, Booster Spirit 50 2T 03-00, Booster Track 50 2T 96-98, Flipper Euro 2 50 2T 03-03, Mach G 50 2T 02-04, Mach G LC 50 2T 02-04, Nitro 50 2T -00, Nitro Euro 2 50 2T 03-03, Ovetto 50 2T -00, Ovetto Euro 2 50 2T 02-02, Sorriso 50 2T 95-96, Stunt 50 2T 00-02, Target 50 2T 91-95

Syncro 50 2T -00, Thunder 50 2T -00

First 50 2T -00, Windy 50 2T -00

Aerox 50 2T -00, Aerox Euro 2 50 2T 03-03, BWS 50 2T -00, BWS Bump 50 2T 97-98, BWS Euro 2 50 2T 03-03, BWS NG 50 2T -00, BWS NG Euro 2 50 2T 03-03, CRZ 50 2T 91-95, CT 50 2T 90-95, Jog R 50 2T 02-10, Jog R LC 50 2T -00, Neo's 50 2T -00, Neo's Euro 2 50 2T 02-02, Slider 50 2T 00-02, Spy 50 2T 95-98, Why 50 2T -00, Why Euro 2 50 2T 03-03, Zuma 50 2T 97-01



◀ cod. **9924940** **RACING**
Campane frizione "TPR" ø 107 per motore scooter 50cc Minarelli/Yamaha orizzontale

APPLICABILITÀ

Aprilia	Area 51 50 2T 98-00, Gulliver 50 2T 95-98, Gulliver LC 50 2T 96-98, Rally 50 2T 95-03, Rally Liquid Cooled 50 2T 96-99, SR (Orizzontale) 50 2T 94-96, SR Liquid Cooled 50 2T 94-96, SR Recing 50 2T 97-99, SR Stealth 50 2T 97-99, SR WWW 50 2T 97-01, Scarabeo 50 2T 93-05, Sonic 50 2T 98-07, Sonic GP 50 2T 98-08	Malaguti	Centro 50 2T-00, Ciak 50 2T-00, Ciak Euro 2,2,3 50 2T 03-03, Ciak Euro 2 50 2T 01-03, Ciak Master Euro 2 50 2T 06-06, F10 50 2T-00, F10 Euro 2 50 2T-00, F10 Euro 2,2,3 50 2T 03-04, F10 Restyling Euro 2 50 2T 06-06, F12 Phantom 50 2T-00, F12 Phantom Euro 2,2,3 50 2T 03-04, F12 Phantom LC 50 2T-00, F12 R Phantom LC 50 2T 07-09, F12 Restyling Euro 2 50 2T 02-06, F15 Firefox Euro 2 50 2T-00, F15 Firefox Euro 2 50 2T 02-06, F15 Firefox Euro 2,2,3 50 2T 03-04, Yesterday 50 2T 97-00
Atala	Carosello 50 2T-00	Mbk	Evolis 50 2T 92-95, Fizz 50 2T 94-95, Flipper 50 2T-00, Flipper Euro 2 50 2T 03-03, Forte 50 2T 94-96, Mach G 50 2T 02-04, Mach G LC 50 2T 02-04, Nitro 50 2T-00, Nitro Euro 2 50 2T 03-03, Ovetto 50 2T-00, Ovetto Euro 2 50 2T 02-02
Benelli	491 GT 50 2T 98-99, 491 RR 50 2T 99-01, 491 Racing 50 2T 98-99, 491 SP 50 2T 99-99, 491 ST 50 2T 99-01, 491 Sport 50 2T 98-99, K2 50 2T 98-01, K2 Liquid Cooled 50 2T 98-01, Naked 50 2T 02-02, Pepe 50 2T 99-01, Pepe LX 50 2T 03-04	Motron	Syncro 50 2T-00, Thunder 50 2T-00
Beta	Ark 50 2T 96-08, Ark LC 50 2T 96-08, Chrono 50 2T 96-00, Eikon 50 2T 99-03, Quadra 50 2T 95-00, Tempo 50 2T 95-00	Rieju	First 50 2T-00, Windy 50 2T-00
Italjet	Dragster 50 2T-00	Yamaha	Aerox 50 2T-00, Aerox Euro 2 50 2T 03-03, Axis 50 2T 95-96, Breeze 50 2T 94-95, Jog 50 2T-00, Jog R 50 2T 02-10, Jog R LC 50 2T-00, Neo's 50 2T-00, Neo's Euro 2 50 2T 02-02, Why 50 2T-00, Why Euro 2 50 2T 03-03
KTM	K50 50 2T-00		
Macal	Thunder 50 2T-00		



◀ cod. **9924950** **RACING**
Campane frizione "TPR" ø 107 scooter 50 cc Piaggio

APPLICABILITÀ

Aprilia	Mojito 50 2T -, SR R 50 2T 04-09, SR R FACTORY Carburatore 50 2T -, SR R FACTORY IE 50 2T -, SR Street Carburatore 50 2T 03-12, Scarabeo 2T EU2 Motore Piaggio 50 2T 10-12, Scarabeo 2T Net 50 2T 09-10, Scarabeo 4T 50 4T 02-06, Scarabeo 4T 4V 50 4T-4V 10-12, Scarabeo 4T 4V NET 50 4T-4V 09-10, Scarabeo 4T Restyling EU3 50 4T 06-09, Scarabeo Quattro 50 4T-4V 09-09, Scarabeo Street 50 2T 05-06, Scarabeo Street 2T Restyling 50 2T 06-09, Sport City One 2T 50 2T 08-11, Sport City One 4T 50 4T 08-10	Italjet	Jet Set 50 2T-00, Torpedo New 50 2T-00
Derbi	Atlantis 2T 50 2T 10-10, Atlantis 2T EU2 50 2T 07-09, Atlantis O2 50 2T 02-02, Atlantis O2 Bullet 50 2T 03-05, Atlantis O2 City 50 2T 03-06, Atlantis O2 Red Bullet 50 2T 03-03, Atlantis O2 Two Chic 50 2T 05-05, Boulevard 50 2T 09-12, GP1 50 2T 01-03, GP1 EU2 50 2T 05-05, GP1 Open EU2 50 2T 06-09, GP1 Race EU2 50 2T 05-07, Sonar 2T 50 2T 09-09	Piaggio	Diesis 50 2T 01-01, Fly 2T 50 2T 05-07, Fly 2T 50 2T 10-11, Free 50 2T 92-94, Free Delivery 50 2T 00-01, Free FL 50 2T 95-02, Liberty 50 2T 97-05, Liberty 2T 50 2T 06-08, Liberty 2T PTT EU2 50 2T 04-05, Liberty 2T RST 50 2T 04-04, Liberty 2T Sport 50 2T 06-08, Liberty MOC 2T & Elle 50 2T -, NRG 50 2T 94-96, NRG Extreme 50 2T 99-00, NRG MC3 50 2T 01-04, NRG Power DD 50 2T 05-13, NRG Power DD Serie Speciale 50 2T -, NRG Power DT 50 2T 06-11, NRG Power DT Serie Speciale 50 2T 07-08, NRG Power Pure Jet 50 2T-IE 04-05, NRG Power PureJet 50 2T-IE 06-11, NRG PureJet 50 2T-IE 02-04, NRG PureJet 50 2T-IE 10-10, NRG RST MC2 50 2T 96-98, NTT 50 2T 95-96, Quartz 50 2T 92-96, Sfera 50 2T 91-93, Sfera Maquillage 2 50 2T 94-94, Sfera RST 50 2T 95-97, Typhoon 50 2T 01-11, Typhoon 2T E2 50 2T 10-12, Typhoon 2T E3 CH 50 2T 11-11, Vespa ET2 50 2T 97-05, Vespa ET2 iniezione 50 2T 97-00, Vespa LX 2T 50 2T 05-08, Vespa LX 2T FL 50 2T 09-10, Vespa LX 2T Touring 50 2T 10-11, Vespa LXV 2T 50 2T -, Vespa LXV 2T NAVY 50 2T 08-08, Vespa S 2T & College 50 2T 07-12, Zip 50 2T 92-93, Zip 50 2T 95-96, Zip 2T 50 2T -, Zip Bimodale 50 2T 94-97, Zip Fast Rider 50 2T 93-94, Zip Fast Rider RST 50 2T 96-97, Zip LC 50 2T 00-04, Zip RST 50 2T 96-99, Zip Sp 50 2T 96-04, Zip Sp Euro 2 50 2T
Gilera	DNA 50 2T 00-02, DNA 50 2T 05-07, DNA GP Experience 50 2T 03-04, Easy Moving 50 2T 95-96, Ice 50 2T 01-05, Runner 50 2T 97-00, Runner Poggiali 50 2T 02-02, Runner Pure Jet 50 2T-IE 02-07, Runner Pure Jet 50 2T-IE 10-11, Runner Pure Jet ST 50 2T-IE 08-08, Runner SP 50 2T 02-07, Runner SP 50 2T 10-12, Runner SP ST & Simoncelli 50 2T 08-09, Runner SP Special Edition 50 2T 07-07, Stalker 50 2T 97-11, Stalker Naked 50 2T 08-08, Stalker Special Edition 50 2T 07-08, Storm 50 2T 94-95, Storm Euro 2 50 2T 07-07, Typhoon 50 2T 94-97, Typhoon X 50 2T 98-99, Typhoon XR 50 2T 00-00		



cod. 9908240

Set 3 serie molle per frizione a 2 ceppi con campana ø interno 105 mm, carico differenziato

Codice	Colore	Carico kg
9912900	VERDE	8
9912920	VIOLA	10,5
9912910	ROSA	12,8

APPLICABILITÀ

Aprilia	Amico 50 2T 94-94, Amico 50 2T 96-98, Amico GL/GLE 50 2T 93-95, Amico LX/Sport/Cat 50 2T 92-93, Area 51 50 2T 98-00, Gulliver 50 2T 95-98, Gulliver LC 50 2T 96-98, Rally 50 2T 95-03, Rally Liquid Cooled 50 2T 96-99, SR (Orizzontale) 50 2T 94-96, SR (Verticale) 50 2T 93-93, SR Liquid Cooled 50 2T 94-96, SR Recing 50 2T 97-99, SR Stealth 50 2T 97-99, SR WWW 50 2T 97-01, Scarabeo 50 2T 93-05, Sonic 50 2T 98-07, Sonic GP 50 2T 98-08	Malaguti	Centro 50 2T -00, Ciak 50 2T -00, Ciak Euro 2,2,3 50 2T 03-03, Ciak Euro2 50 2T 01-03, F10 50 2T -00, F10 Euro 2 50 2T -00, F10 Euro 2,2,3 50 2T 03-04, F12 Phantom 50 2T -00, F12 Phantom Euro 2,2,3 50 2T 03-04, F12 Phantom LC 50 2T -00, F12 Phantom LC Euro 2,2,3 50 2T 03-04, F12 Restyling Euro 2 50 2T 06-06, F15 Firefox 50 2T -00, F15 Firefox Euro 2 50 2T 02-03, F15 Firefox Euro 2,2,3 50 2T 03-04, Yesterday 50 2T 97-00
Atala	Carosello 50 2T -00	Mbk	Booster 50 2T -00, Booster Euro 2 50 2T 04-04, Booster NG 50 2T 03-00, Booster Rocket 50 2T 97-98, Booster Spirit 50 2T 03-00, Booster Track 50 2T 96-98, Flipper 50 2T -00, Flipper Euro 2 50 2T 03-03, Mach G 50 2T 02-04, Mach G LC 50 2T 02-04, Nitro 50 2T -00, Nitro Euro 2 50 2T 03-03, Ovetto 50 2T -00, Ovetto Euro 2 50 2T 02-02, Sorriso 50 2T 95-96, Stunt 50 2T 00-02, Target 50 2T 91-95
Benelli	491 GT 50 2T 98-99, 491 RR 50 2T 99-01, 491 Racing 50 2T 98-99, 491 SP 50 2T 99-99, 491 ST 50 2T 99-01, 491 Sport 50 2T 98-99, K2 50 2T 98-01, K2 Liquid Cooled 50 2T 98-01, Naked 50 2T 02-02, Pepe 50 2T 99-01, Pepe 50 2T 10-10, Pepe LX 50 2T 03-04	Motron	Syncro 50 2T -00, Thunder 50 2T -00
Beta	Ark 50 2T 96-08, Ark LC 50 2T 96-08, Chrono 50 2T 96-00, Eikon 50 2T 99-03, Quadra 50 2T 95-00, Tempo 50 2T 95-00	Rieju	First 50 2T -00, Windy 50 2T -00
Italjet	Bazooka 50 2T -00, Dragster 50 2T -00, Pista 50 2T -00, Pista 2 50 2T -00, Scoop 50 2T -00, Scoop 2 50 2T -00, Yankee 50 2T -00	Yamaha	Aerox 50 2T -00, Aerox Euro 2 50 2T 03-03, BWS 50 2T -00, BWS Bump 50 2T 97-98, BWS Euro 2 50 2T 03-03, BWS NG 50 2T -00, BWS NG Euro 2 50 2T 03-03, CRZ 50 2T 91-95, CT 50 2T 90-95, Jog R 50 2T 02-10, Jog R LC 50 2T -00, Neo's 50 2T -00, Neo's Euro 2 50 2T 02-02, Slider 50 2T 00-02, Spy 50 2T 95-98, Why 50 2T -00, Why Euro 2 50 2T 03-03, Zuma 50 2T 97-01
KTM	K50 50 2T -00		
Macal	Thunder 50 2T -00		



cod. 9911250

Set 3 serie molle per frizione a 3 ceppi con campana ø interno 105 mm e 107 mm (cod. 9911060 cod. 9910020)

APPLICABILITÀ

Aprilia	Amico 50 2T 94-94, Amico 50 2T 96-98, Amico GL/GLE 50 2T 93-95, Amico LX/Sport/Cat 50 2T 92-93, Area 51 50 2T 98-00, Gulliver 50 2T 95-98, Gulliver LC 50 2T 96-98, Mojito 50 2T -, Rally 50 2T 95-03, Rally Liquid Cooled 50 2T 96-99, SR (Orizzontale) 50 2T 94-96, SR (Verticale) 50 2T 93-93, SR Liquid Cooled 50 2T 94-96, SR R 50 2T 04-09, SR R FACTORY Carburatore 50 2T -, SR R FACTORY IE 50 2T -, SR Recing 50 2T 97-99, SR Stealth 50 2T 97-99, SR Street Carburatore 50 2T 03-12, SR WWW 50 2T 97-01, Scarabeo 50 2T 93-05, Scarabeo 2T EU2 Motore Piaggio 50 2T 10-12, Scarabeo 2T Net 50 2T 09-10, Scarabeo 4T 50 4T 02-06, Scarabeo 4T 4V 50 4T-4V 10-12, Scarabeo 4T 4V NET 50 4T-4V 09-10, Scarabeo 4T Restyling EU3 50 4T 06-09, Scarabeo Quattro 50 4T-4V 09-09, Scarabeo Street 50 2T 05-06, Scarabeo Street 2T Restyling 50 2T 06-09, Sonic 50 2T 98-07, Sonic GP 50 2T 98-08, Sport City One 2T 50 2T 08-11, Sport City One 4T 50 4T 08-10	Gilera	DNA 50 2T 00-02, DNA 50 2T 05-07, DNA GP Experience 50 2T 03-04, Easy Moving 50 2T 95-96, Ice 50 2T 01-05, Runner 50 2T 97-00, Runner Poggiali 50 2T 02-02, Runner SP 50 2T 02-07, Runner SP 50 2T 10-12, Runner SP ST & Simoncelli 50 2T 08-09, Runner SP Special Edition 50 2T 07-07, Stalker 50 2T 97-11, Stalker Naked 50 2T 08-08, Stalker Special Edition 50 2T 07-08, Storm 50 2T 94-95, Storm Euro 2 50 2T 07-07, Typhoon 50 2T 94-97, Typhoon X 50 2T 98-99	Motron	Syncro 50 2T -00, Thunder 50 2T -00
Atala	Carosello 50 2T -00	HSC	SC 01 50 2T -00, SC 01 L 50 2T -00		
BSV	Dio GP 50 2T -00, Dio SP 50 2T -00, Dio ZX 50 2T -00	Honda	Bali 50 2T 93-99, Dio ZX 50 2T -00, SFX / SXR 50 2T -, SGX SKY 50 2T -, SH New 50 2T 96-01		
Benelli	491 GT 50 2T 98-99, 491 RR 50 2T 99-01, 491 Racing 50 2T 98-99, 491 SP 50 2T 99-99, 491 ST 50 2T 99-01, 491 Sport 50 2T 98-99, K2 50 2T 98-01, K2 Liquid Cooled 50 2T 98-01, Naked 50 2T 02-02, Pepe 50 2T 99-01, Pepe 50 2T 10-10, Pepe LX 50 2T 03-04	Italjet	Bazooka 50 2T -00, Dragster 50 2T -00, Jet Set 50 2T -00, Pista 50 2T -00, Pista 2 50 2T -00, Scoop 50 2T -00, Scoop 2 50 2T -00, Torpedo New 50 2T -00, Yankee 50 2T -00		
Beta	Ark 50 2T 96-08, Ark LC 50 2T 96-08, Chrono 50 2T 96-00, Eikon 50 2T 99-03, Quadra 50 2T 95-00, Tempo 50 2T 95-00	KTM	K50 50 2T -00		
Derbi	Atlantis 2T 50 2T 10-10, Atlantis 2T EU2 50 2T 07-09, Atlantis O2 50 2T 02-02, Atlantis O2 Bullet 50 2T 03-05, Atlantis O2 City 50 2T 03-06, Atlantis O2 Red Bullet 50 2T 03-03, Atlantis O2 Iwo Chic 50 2T 05-05, Boulevard 50 2T 09-12, GP1 50 2T 01-03, GP1 EU2 50 2T 05-05, GP1 Open EU2 50 2T 06-09, GP1 Race EU2 50 2T 05-07, Sonar 2T 50 2T 09-09	Kymco	Agility R12 50 4T 05-05		
		Macal	Thunder 50 2T -00		
		Malaguti	Centro 50 2T -00, Ciak 50 2T -00, Ciak Euro 2,2,3 50 2T 03-03, Ciak Euro2 50 2T 01-03, F10 50 2T -00, F10 Euro 2 50 2T -00, F10 Euro 2,2,3 50 2T 03-04, F12 Phantom 50 2T -00, F12 Phantom Euro 2 50 2T 02-02, F12 Phantom Euro 2,2,3 50 2T 03-04, F12 Phantom LC 50 2T -00, F12 Phantom LC Euro 2,2,3 50 2T 03-04, F12 Restyling Euro 1 50 2T 99-02, F12 Restyling Euro 2 50 2T 06-06, F15 Firefox 50 2T -00, F15 Firefox Euro 2 50 2T 02-03, F15 Firefox Euro 2,2,3 50 2T 03-04, Yesterday 50 2T 97-00		
		Mbk	Booster 50 2T -00, Booster Euro 2 50 2T 04-04, Booster NG 50 2T 03-00, Booster Rocket 50 2T 97-98, Booster Spirit 50 2T 03-00, Booster Track 50 2T 96-98, Flipper 50 2T -00, Flipper Euro 2 50 2T 03-03, Mach G 50 2T 02-04, Mach G LC 50 2T 02-04, Nitro 50 2T -00, Nitro Euro 2 50 2T 03-03, Ovetto 50 2T -00, Ovetto Euro 2 50 2T 02-02, Sorriso 50 2T 95-96, Stunt 50 2T 00-02, Target 50 2T 91-95		
		Peugeot	Buxy 50 2T -00, Buxy RS 50 2T -00, Elyseo 50 2T -00, Jet Force 50 2T -00, Looxor 50 2T -00, Metal X 50 2T -00, SV Geo 50 2T -00, Speedake 50 2T -00, Speedfight 50 2T -00, Squab 50 2T -00, Trekker 50 2T -00, Vivacity 50 2T -00, X-Fight 50 2T -00, Zenith 50 2T -00		
		Piaggio	Diesis 50 2T 01-01, Fly 2T 50 2T 05-07, Fly 2T 50 2T 10-11, Fly 4T 50 4T 05-07, Fly 4T & 25-30 KM/H 50 4T 08-11, Fly 4T Motore CHN 50 4T 06-07, Free 50 2T 92-94, Free Delivery 50 2T 00-01, Liberty 50 2T 97-05, Liberty 2T 50 2T 06-08, Liberty 2T PTT EU2 50 2T 04-05, Liberty 2T RST 50 2T 04-04, Liberty 2T Sport 50 2T 06-08, Liberty 4T 50 4T 00-02, Liberty 4T 50 4T 05-08, Liberty 4T Delivery - Single 50 4T 10-12, Liberty 4T Delivery TNT 50 4T 09-09, Liberty 4T PTT - DOUBLE 50 4T 09-12, Liberty 4T RST 50 4T 04-04, Liberty 4T Sport 50 4T 06-08, Liberty MOC 2T & Elle 50 2T -, Liberty MOC 4T & Elle 50 4T 09-13, NRG 50 2T 94-96, NRG Power DT 50 2T 06-11, NRG Power DT Serie Speciale 50 2T 07-08, NRG RST MC2 50 2T 96-98, NTT 50 2T 95-96, Quartz 50 2T 92-96, Sfera 50 2T 91-93, Sfera Maguillage 2 50 2T 94-94, Sfera RST 50 2T 95-97, Typhoon 2T E2 50 2T 10-12, Typhoon 2T E3 CH 50 2T 11-11, Vespa ET2 50 2T 97-05, Vespa ET4 50 4T 00-05, Zip 50 2T 92-93, Zip 50 2T 95-96, Zip 4T 50 4T 00-13, Zip Bimodale 50 2T 94-97, Zip Fast Rider 50 2T 93-94, Zip Fast Rider RST 50 2T 96-97, Zip RST 50 2T 96-99, Zip Sp 50 2T 96-00		
		Rieju	First 50 2T -00, Windy 50 2T -00		
		Yamaha	Aerox 50 2T -00, Aerox Euro 2 50 2T 03-03, BWS 50 2T -00, BWS Bump 50 2T 97-98, BWS Euro 2 50 2T 03-03, BWS NG 50 2T -00, BWS NG Euro 2 50 2T 03-03, CRZ 50 2T 91-95, CT 50 2T 90-95, Jog R 50 2T 02-10, Jog R LC 50 2T -00, Neo's 50 2T -00, Neo's Euro 2 50 2T 02-02, Slider 50 2T 00-02, Spy 50 2T 95-98, Why 50 2T -00, Why Euro 2 50 2T 03-03, Zuma 50 2T 97-01		

Codice	Colore	Carico kg
9912900	GIALLO	6,3
9912920	VERDE	9
9912910	VIOLA	13



cod. 9908850

Set 3 serie molle per frizione a 3 ceppi con campana ø interno 112 mm

Codice	Colore	Carico kg
9912900	VERDE	11
9912920	VIOLA	14
9912910	ROSA	17

APPLICABILITÀ

Benelli Pepe 50 2T 10-10, Pepe LX 50 2T 03-04, Pepe LX 50 2T 07-09, Pepe Old 50 2T 07-09, Pepe Old 50 2T 11-11, Quattronex 50 2T 08-11

CPI Aragon 50 2T 03-03, Hussar 50 2T 03-03, Oliver 50 2T 03-03, Pop Corn 50 2T 03-03

Keeway F-Act 50 2T 07-08, Flash 50 2T 07-08, Focus 50 2T 06-06, Goccia 50 2T 09-09, Hurricane 50 2T 06-08, Matrix 50 2T 06-08, Pixel Euro 2 50 2T -00, RY8 50 2T 08-08

Mbk Evolis 50 2T 92-95, Fizz 50 2T 94-95, Forte 50 2T 94-96
Yamaha Axis 50 2T 95-96, Breeze 50 2T 94-95T



cod. 9912740

Set 3 serie molle per frizione originale a 3 ceppi con campana ø interno 107 mm

Codice	Colore	Carico kg
9912900	VERDE	8
9912920	VIOLA	10
9912910	ROSA	12

APPLICABILITÀ

Aprilia Area 51 50 2T 98-00, Gulliver 50 2T 95-98, Gulliver LC 50 2T 96-98, Rally 50 2T 95-03, Rally Liquid Cooled 50 2T 96-99, SR Liquid Cooled 50 2T 94-96, SR Racing 50 2T 97-99, SR Stealth 50 2T 97-99, Scarabeo 50 2T 93-05, Sonic 50 2T 98-07, Sonic GP 50 2T 98-08

Benelli 491 GT 50 2T 98-99, 491 RR 50 2T 99-01, 491 Racing 50 2T 98-99, 491 SP 50 2T 99-99, 491 ST 50 2T 99-01, 491 Sport 50 2T 98-99, K2 50 2T 98-01, K2 Liquid Cooled 50 2T 98-01, Naked 50 2T 02-02, Pepe 50 2T 99-01, Pepe 50 2T 10-10, Pepe LX 50 2T 03-04

Beta Ark 50 2T 96-08, Ark LC 50 2T 96-08, Chrono 50 2T 96-00, Eikon 50 2T 99-03, Quadra 50 2T 95-00, Tempo 50 2T 95-00

Garelli GPS 50 2T 09-11

Italjet Dragster 50 2T -00

Kymco Agility 4T R10 50 4T 06-08, Agility 4T R12 50 4T 07-08, Agility R12 50 4T 05-05, Agility R16 50 4T 08-09, Agility R16 50 4T 12-12, Agility R16 2T 50 2T 10-10, Agility R16 2T 50 2T 12-12, Agility RS 50 4T 09-09, Agility RS Naked 50 2T 10-10, Bet & Win 50 2T 02-02, Bet & Win EU2 50 2T 03-03, CX 50 2T 93-93, CX Super 50 2T 94-97, DJ World 50 2T 94-00, DJ X 50 2T 91-92, DJ Y 50 2T 93-93, Dink Classic EU2 50 2T 03-03, Dink Euro 2 50 4T 07-07, Fever ZX 50 2T 99-00, Fever ZX EU2 50 2T 03-04, Filly 50 4T 98-00, Filly LX 50 4T 01-02, Heroism 50 2T 95-97, K 12 50 2T 95-00, KB 50 2T 95-00, People 50 2T 99-04, People Euro 2 50 2T 03-03, People Euro 2 50 2T 08-08, People S 50 2T 05-08, People S 4T 50 4T 06-08, Sento 50 4T 08-08,

Sniper 50 2T 93-93, Sniper DD 50 2T 94-96, Super 9 50 2T 00-00, Super 9 EU2 50 2T 03-04, Vitality 2T 50 2T 04-04, Vitality 4T 50 4T 04-04, Yup 50 2T 02-02, Yup EU2 50 2T 03-03

Malaguti Ciak 50 2T -00, Ciak Euro 2 2,3 50 2T 03-03, Ciak Euro 2 50 2T 01-03, Ciak Master Euro 2 50 2T 06-06, F10 Euro 2 50 2T -00, F10 Euro 2,2,3 50 2T 03-04, F10 Restyling Euro 2 50 2T 06-06, F12 Phantom 50 2T -00, F12 Phantom Euro 2 50 2T 02-02, F12 Phantom Euro 2 2,3 50 2T 03-04, F12 Phantom LC Euro 2 2,3 50 2T 03-04, F12 R Phantom LC 50 2T 07-09, F12 Restyling Euro 1 50 2T 99-02, F12 Restyling Euro 2 50 2T 06-06, F12 Restyling LC Euro 2 50 2T 06-06, F15 Firefox 50 2T -00, F15 Firefox Euro 2 50 2T 02-06, F15 Firefox Euro 2 2,3 50 2T 03-04, Yesterday 50 2T 97-00

Mbk Booster 50 2T -00, Booster Euro 2 50 2T 04-04, Booster NG 50 2T 03-00, Booster Spirit 50 2T 03-00, Booster X ie 50 4T-3V 08-08, Flipper 50 2T -00, Flipper Euro 2 50 2T 03-03, Mach G 50 2T 02-04, Mach G LC 50 2T 02-04, Nitro 50 2T -00, Nitro Euro 2 50 2T 03-03, Ovetto 50 2T -00, Ovetto 4T 50 4T-3V 09-11, Ovetto Euro 2 50 2T 02-02, Stunt 50 2T 00-02

Yamaha Aerox 50 2T -00, Aerox Euro 2 50 2T 03-03, BWS 50 2T -00, BWS Bump 50 2T 97-98, BWS Euro 2 50 2T 03-03, BWS NG 50 2T -00, BWS NG Euro 2 50 2T 03-03, Giggle 50 4T-3V 08-08, Jog R 50 2T 02-10, Jog R LC 50 2T -00, Neo's 50 2T -00, Neo's 4 50 4T-3V 09-11, Neo's Euro 2 50 2T 02-02, Slider 50 2T 00-02, Why 50 2T -00, Why Euro 2 50 2T 03-03, Zest 50 2T -00, Zuma 50 2T 97-01



KIT ASPIRAZIONE

KIT ASPIRAZIONE - KIT COLLETTORI - CARBURATORE OKO 28



◀ cod. **9931710** **RACING**
 Kit aspirazione completo TPR per scooter 50cc Minarelli/Yamaha orizzontale
 collettore 360° - carburatore OKO 28

RICAMBI

9929270	Flangia
9929290	Collettore

9931770	Filtro aria
9932000	Carburatore OKO 28



◀ cod. **9931700** **RACING**
 Kit collettore TPR 360° scooter 50cc Minarelli/Yamaha orizzontale per carburatore OKO 28

RICAMBI

9929270	Flangia
---------	---------

9929290	Collettore
---------	------------



◀ cod. **9931730** **RACING**
 Kit aspirazione completo TPR per scooter 50cc Piaggio
 collettore 360° - carburatore OKO 28

RICAMBI

9929210	Flangia
9929230	Collettore

9931770	Filtro aria
9932000	Carburatore OKO 28



◀ cod. **9931720** **RACING**
 Kit collettore TPR 360° scooter 50cc Piaggio per carburatore OKO 28

RICAMBI

9929210	Flangia
---------	---------

9929230	Collettore
---------	------------

ATTENZIONE: QUESTI PRODOTTI SONO DESTINATI ESCLUSIVAMENTE AD USO AGONISTICO. NE E' QUINDI VIETATO L'UTILIZZO SU STRADA PUBBLICA.



cod. **9931750** **RACING**

Kit aspirazione completo TPR per AM/Derbi 50cc
collettore 360° - carburatore OKO 28

RICAMBI

9929240	Flangia
9929260	Collettore

9931770	Filtro aria
9932000	Carburatore OKO 28



cod. **9931740** **RACING**

Kit collettore TPR 360° AM/Derbi 50cc per carburatore OKO 28

RICAMBI

9929240	Flangia
---------	---------

9929260	Collettore
---------	------------



cod. **9931770** **RACING**

Filtro aria spugna imbocco Ø 49 mm

A RICAMBIO PER

9931710	Kit aspirazione completo TPR per scooter 50cc Minarelli/Yamaha orizzontale collettore 360° - carburatore OKO 28
9931730	Kit aspirazione completo TPR per scooter 50cc Piaggio collettore 360° - carburatore OKO 28
9931750	Kit aspirazione completo TPR per AM/Derbi 50cc collettore 360° - carburatore OKO 28



cod. **9932800** **RACING**

Kit aspirazione completo per vespa PX 125/150 cc TPR collettore 360° - carburatore OKO 28

RICAMBI

9931770	Filtro Aria
9932000	Carburatore Oko 28
9932890	Kit Collettore
9933240	Kit Flangia Inferiore



KIT ASPIRAZIONE

CARBURATORE OKO 28



RACING

▲ cod. **9932000**
Carburatore OKO 28

A RICAMBIO PER

9931710	Kit aspirazione completo TPR per scooter 50cc Minarelli/Yamaha orizzontale collettore 360° - carburatore OKO 28
9931730	Kit aspirazione completo TPR per scooter 50cc Piaggio collettore 360° - carburatore OKO 28
9931750	Kit aspirazione completo TPR per AM/Derbi 50cc collettore 360° - carburatore OKO 28
9932800	Kit aspirazione completo TPR per Vespa Px 125/150cc - Collettore 360° Oko 28

GETTI

DESCRIZIONE	CODICE	DESCRIZIONE	CODICE
GETTO MINIMO OKO #30	9940300	GETTO MASSIMO OKO #132	9941320
GETTO MINIMO OKO #32	9940320	GETTO MASSIMO OKO #135	9941350
GETTO MINIMO OKO #34	9940340	GETTO MASSIMO OKO #138	9941380
GETTO MINIMO OKO #36	9940360	GETTO MASSIMO OKO #140	9941400
GETTO MINIMO OKO #38	9940380	GETTO MASSIMO OKO #142	9941420
GETTO MINIMO OKO #40	9940400	GETTO MASSIMO OKO #145	9941450
GETTO MINIMO OKO #42	9940420	GETTO MASSIMO OKO #148	9941480
GETTO MINIMO OKO #44	9940440	GETTO MASSIMO OKO #150	9941500
GETTO MINIMO OKO #46	9940460	GETTO MASSIMO OKO #152	9941520
GETTO MINIMO OKO #48	9940480	GETTO MASSIMO OKO #155	9941550
GETTO MINIMO OKO #50	9940500	GETTO MASSIMO OKO #158	9941580
GETTO MINIMO OKO #52	9940520	GETTO MASSIMO OKO #160	9941600
GETTO MINIMO OKO #54	9940540	GETTO MASSIMO OKO #162	9941620
GETTO MINIMO OKO #56	9940560	GETTO MASSIMO OKO #165	9941650
GETTO MINIMO OKO #58	9940580	GETTO MASSIMO OKO #168	9941680
GETTO MINIMO OKO #60	9940600	GETTO MASSIMO OKO #170	9941700
GETTO MASSIMO OKO #100	9941000	GETTO MASSIMO OKO #172	9941720
GETTO MASSIMO OKO #102	9941020	GETTO MASSIMO OKO #175	9941750
GETTO MASSIMO OKO #105	9941050	GETTO MASSIMO OKO #178	9941780
GETTO MASSIMO OKO #108	9941080	GETTO MASSIMO OKO #180	9941800
GETTO MASSIMO OKO #110	9941100	GETTO MASSIMO OKO #182	9941820
GETTO MASSIMO OKO #112	9941120	GETTO MASSIMO OKO #185	9941850
GETTO MASSIMO OKO #115	9941150	GETTO MASSIMO OKO #188	9941880
GETTO MASSIMO OKO #118	9941180	GETTO MASSIMO OKO #190	9941900
GETTO MASSIMO OKO #120	9941200	GETTO MASSIMO OKO #192	9941920
GETTO MASSIMO OKO #122	9941220	GETTO MASSIMO OKO #195	9941950
GETTO MASSIMO OKO #125	9941250	GETTO MASSIMO OKO #198	9941980
GETTO MASSIMO OKO #128	9941280	GETTO MASSIMO OKO #200	9942000
GETTO MASSIMO OKO #130	9941300		

ATTENZIONE: QUESTI PRODOTTI SONO DESTINATI ESCLUSIVAMENTE AD USO AGONISTICO. NE E' QUINDI VIETATO L'UTILIZZO SU STRADA PUBBLICA.

KIT ASPIRAZIONE

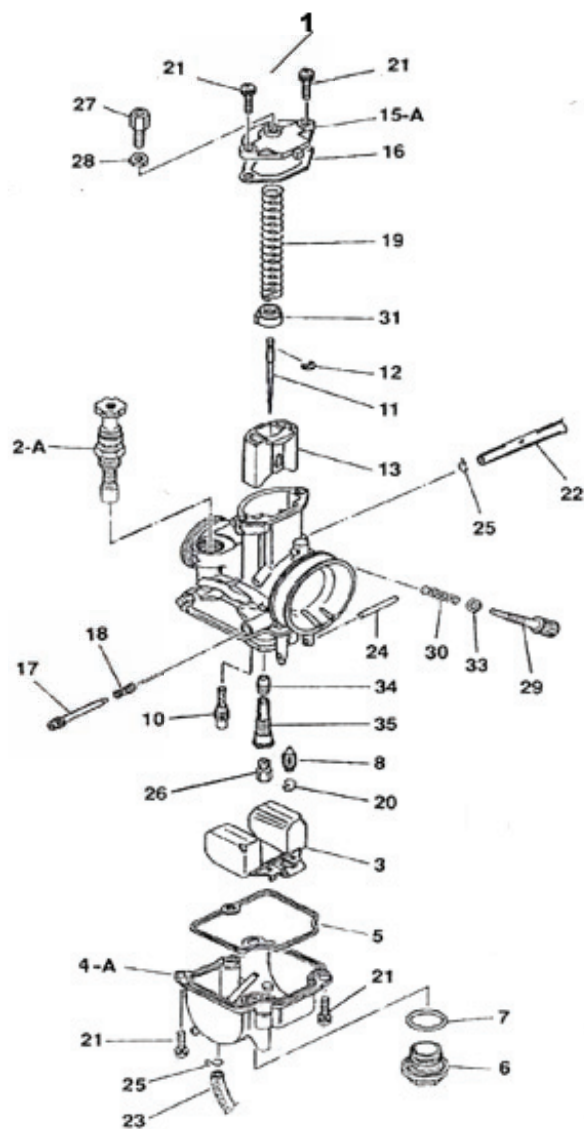

OPTION

2 - B

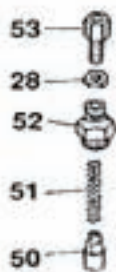

OPTION

4 - B

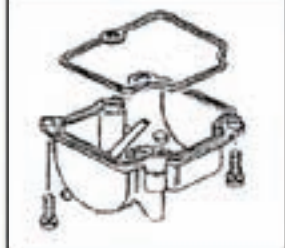

OPTION

15 - B



RICAMBI

N°	DESCRIZIONE	CODICE
1	Carburatore OKO 28	9932000
2A	Comando Starter	9932010
2B	Comando Starter a Filo	9932020
3	Galleggiante	9932030
4A	Vaschetta Carburatore	9932040
4B	Vaschetta Carburatore Trasparente	9932050
5	Guarnizione Vaschetta	9932060
6	Tappo Vaschetta	9932070
7	O-Ring Tappo Vaschetta	9932080
8	Spillo Benzina	9932090
10	Getto Minimo #48	9940480
11	Spillo Conico [JJH]	9932110
12	Seeger Spillo Conico	9932120
13	Valvola Gas	9932130
15A	Coperchio Valvola	9932140
15B	Coperchio Valvola con Registro Curvo	9932150
16	Guarnizione Coperchio Valvola	9932160
17	Vite Aria	9932170
18	Molla Vite Aria	9932180
19	Molla Valvola Gas	9932190
20	Seeger Spillo Benzina	9932200
21	Vite fissaggio Vaschetta/Coperchio	9932210
22	Tubetto Sfiato	9932220
23	Tubetto Troppo Pieno	9932230
24	Perno Galleggiante	9932240
25	Seeger Tubetti	9932250
26	Getto Massimo #130	9941300
27	Registro Cavo Gas	9932270
28	Dado Registro Cavo Gas	9932280
29	Vite Registro Valvola Gas	9932290
30	Molla Vite Registro Valvola Gas	9932300
31	Guida Molla Valvola Gas	9932310
33	Rondella Vite Registro Valvola Gas	9932320
34	Ugello Polverizzatore	9932330
35	Polverizzatore	9932340
50	Valvola Starter a Filo	9932350
51	Molla Valvola Starter a Filo	9932360
52	Coperchio Starter a Filo	9932370
53	Registro Starter a Filo	9932380

KIT ASPIRAZIONE - KIT COLLETTORI - CARBURATORE MIKUNI TM 24



◀ cod. **9930820** **RACING**
Kit collettore TPR 360° scooter 50cc Minarelli/Yamaha orizzontale per carburatore Mikuni TM 24

RICAMBI

9929270	Flangia	9929280	Collettore
---------	---------	---------	------------

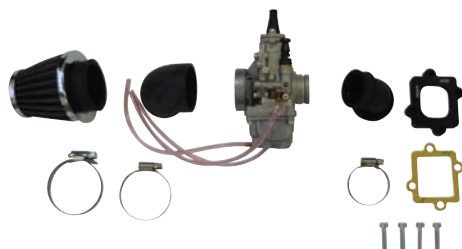

◀ cod. **9930830** **RACING**
Kit aspirazione completo TPR per scooter 50cc Minarelli/Yamaha orizzontale collettore 360° - carburatore Mikuni TM 24

RICAMBI

9908680	Filtro aria	9929270	Flangia
9908730	Carburatore Mikuni TM 24	9929280	Collettore



◀ cod. **9930860** **RACING**
Kit collettore TPR 360° scooter 50cc Piaggio per carburatore Mikuni TM 24

RICAMBI

9929210	Flangia	9929220	Collettore
---------	---------	---------	------------

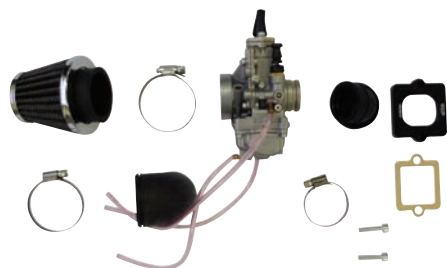

◀ cod. **9930870** **RACING**
Kit aspirazione completo TPR per scooter 50cc Piaggio collettore 360° - carburatore Mikuni TM 24

RICAMBI

9908680	Filtro aria	9929210	Flangia
9908730	Carburatore Mikuni TM 24	9929220	Collettore



◀ cod. **9930900** **RACING**
Kit collettore TPR 360° per AM/Derbi 50cc per carburatore Mikuni TM 24

RICAMBI

9929240	Flangia	9929250	Collettore
---------	---------	---------	------------

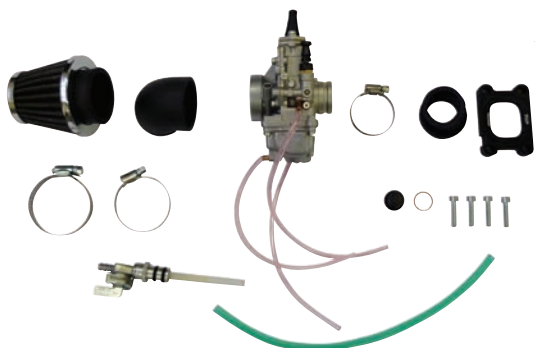

◀ cod. **9930910** **RACING**
Kit aspirazione completo TPR per AM/Derbi 50cc collettore 360° - carburatore Mikuni TM 24

RICAMBI

9908680	Filtro aria	9929240	Flangia
9908730	Carburatore Mikuni TM 24	9929250	Collettore

ATTENZIONE: QUESTI PRODOTTI SONO DESTINATI ESCLUSIVAMENTE AD USO AGONISTICO. NE E' QUINDI VIETATO L'UTILIZZO SU STRADA PUBBLICA.

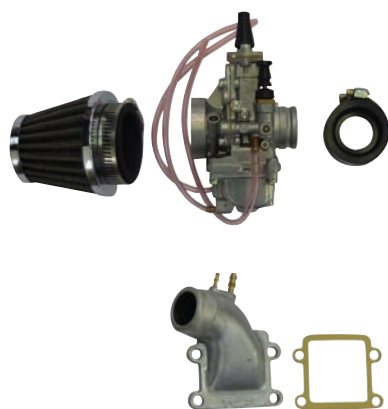

cod. **9908720** **RACING**

Kit aspirazione completo per scooter 50 cc Minarelli/Yamaha verticale carburatore Mikuni TM 24

APPLICABILITÀ

Aprilia Amico 50 2T 94-94, Amico 50 2T 96-98, Amico GL/GLE 50 2T 93-95, Amico LX/Sport/Cat 50 2T 92-93, SR (Verticale) 50 2T 93-93

Italjet Bazooka 50 2T -00, Pista 50 2T -00, Pista 2 50 2T -00, Scoop 50 2T -00, Scoop 2 50 2T -00, Yankee 50 2T -00

Mbk Booster 50 2T -00, Booster Euro 2 50 2T 04-04, Booster NG 50 2T 03-00, Booster Rocket 50 2T 97-98, Booster Spirit 50 2T 03-00, Booster Track 50 2T 96-98, Sorriso 50 2T 95-96, Stunt 50 2T 00-02, Target 50 2T 91-95

Yamaha BWS 50 2T -00, BWS Bump 50 2T 97-98, BWS Euro 2 50 2T 03-03, BWS NG 50 2T -00, BWS NG Euro 2 50 2T 03-03, CRZ 50 2T 91-95, CT 50 2T 90-95, Slider 50 2T 00-02, Spy 50 2T 95-98, Zuma 50 2T 97-01

RICAMBI

9908680	Filtro aria
9908730	Carburatore Mikuni TM 24

9908990	Kit manicotto per carburatore TM 24
9909810	Gomma collettore



cod. **9908730** **RACING**

Carburatore Mikuni TM 24

RICAMBI

9909090	Serie getti per carburatore Mikuni TM 24
9909830	Kit spilli conici per Mikuni TM 24

A RICAMBIO PER

9930830	Kit aspirazione completo TPR per scooter 50cc Minarelli/Yamaha orizzontale collettore 360° - carburatore Mikuni TM 24
9930870	Kit aspirazione completo TPR per scooter 50cc Piaggio - collettore 360° - carburatore Mikuni TM 24

9930910	Kit aspirazione completo TPR per AM/ Derbi 50cc - collettore 360° - carburatore Mikuni TM 24
----------------	--

COLLETTORE



cod. **9906940**

Collettore per motori Minarelli serie AM345 e AM6 carburatore ø19

FILTRI ARIA **RACING**



cod. **9908680**

Filtro aria per carburatori con diametro attacco filtro 42 mm

cod. **9910200**

Filtro aria per carburatori con diametro attacco filtro 39 mm

cod. **9910300**

Filtro aria per carburatori con diametro attacco filtro 42 mm, completo di manicotto a 90°

cod. **9911680**

Filtro aria per carburatori con diametro attacco filtro 35 mm



cod. 9906500

Valvola lamellare con petali in fibra di carbonio (spessore 0,30 mm) per motori Minarelli AM

APPLICABILITÀ

Aprilia	Classic 50 2T 92-99, Europa 50 2T 90-92, MX 50 50 2T 04-04, MX 50 Motard 50 2T 95-03, Pegaso 50 2T 92-94, RS 50 50 2T 91-05, RX 50 50 2T 89-04, RX 50 3-5 Marce 50 2T 91-94, RX 50 Enduro 50 2T 95-03, RX 50 Racing 50 2T 03-06, Tuono 50 50 2T 03-04
Beta	RR Alu 50 2T 00-, RR Enduro 50 50 2T 00-, RR Motard 50 50 2T 00
CH Husqvarna	SM 50 50 2T 00-, WR 50 50 2T 00-, WSM 50 50 2T 00
CMC	Enduro 50 50 2T 11-11, Motard 50 50 2T 11-11
Fantic	Caballero Motard 50 2T 06-10, Caballero Regolarità 50 2T 06-10
HM	Baja, Derapage Basic 50 2T 10-11, CMC 50 2T 10-11, CRE Baja RR, Derapage RR 50 2T 07-11, CRE Baja, Derapage 50 2T 07-11, CRE Six Competition 50 2T 10-11, CRE Six, Baia, Derapage 50 2T 95-06, CRE Six, Derapage Competition 50 2T 07-09, Derapage Competition 50 2T 10-11

Malaguti	CNK Drakon 50 2T 05-07, Fifty Evolution 50 2T 90-93, XSM 50 50 2T 00, XTM 50 50 2T 00
Mbk	X Limit 50 2T 00, X Power 50 2T 00
Minarelli	AM 345 Motori Minarelli 50 2T 00
Motor	Furia 50 50 2T 00, Furia Max 50 50 2T 00, RX 50 50 2T 00, RX 50 R 50 2T 00
Hispania	
Peugeot	Supermotard 50 2T 00, XP6 Trail S/Avv. Elettrico 50 2T 00, XR6 Racing Cat. C/avv.elett. 50 2T 00
Rieju	MRT 50 50 2T 00, MRT 50 PRO 50 2T 00, MRT 50 PRO SM 50 2T 00, MRT 50 SM 50 2T 00, MRX 50 50 2T 00, MRX 50 PRO 50 2T 00, RR 50 50 2T 00, RS1 50 50 2T 00, RS2 50 Matrix 50 2T 00, RS2 50 Matrix Pro 50 2T 00, RS2 Naked 50 50 2T 00, SMX 50 E.S./K.S. 50 2T 00, SMX 50 PRO E.S./K.S. 50 2T 00, Spike 50 50 2T 00
Sherco	HRD Enduro 50 50 2T 00, HRD Motard 50 50 2T 00
Yamaha	DT R 50 2T 03-10, DT RSM 50 2T 03-05, DT X 50 2T 06-10, TZR 50 2T 03-08, TZR 50 2T 10-11, TZR RR 50 2T 05-05

RICAMBI

9906510	Coppia petali in carbonio 0,30 mm
---------	-----------------------------------

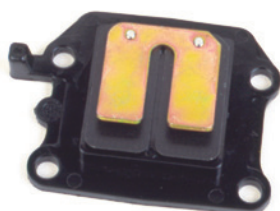

cod. 9906520

Valvola lamellare con petali in fibra di carbonio (spessore 0,30 mm) per motori scooter 50 cc Minarelli/Yamaha tipo verticale

APPLICABILITÀ

Aprilia	Amico 50 2T 94-94, Amico 50 2T 96-98, Amico GL/GLE 50 2T 93-95, Amico LX/Sport/Cat 50 2T 92-93, SR (Verticale) 50 2T 93-93
Mbk	Booster 50 2T 00, Booster Euro 2.50 2T 04-04, Booster NG 50 2T 03-00, Booster Rocket 50 2T 97-98, Booster Spirit 50 2T 03-00, Booster Track 50 2T 96-98, Stunt 50 2T 00-02

Yamaha	BWS 50 2T 00, BWS Bump 50 2T 97-98, BWS Euro 2.50 2T 03-03, BWS NG 50 2T 00, BWS NG Euro 2.50 2T 03-03, Slider 50 2T 00-02, Spy 50 2T 95-98, Zuma 50 2T 97-01
---------------	---

RICAMBI

9910480	Petalo in carbonio 0,30 mm
---------	----------------------------

9908870	Petalo in carbonio 0,40 mm
---------	----------------------------



cod. 9908370

Valvola lamellare con petali in fibra di carbonio (spessore 0,30 mm) per motori scooter 50 cc Minarelli/Yamaha tipo orizzontale

APPLICABILITÀ

Aprilia	Area 51 50 2T 98-00, Gulliver 50 2T 95-98, Gulliver LC 50 2T 96-98, Rally 50 2T 95-03, Rally Liquid Cooled 50 2T 96-99, SR (Orizzontale) 50 2T 94-96, SR Liquid Cooled 50 2T 94-96, SR Recing 50 2T 97-99, SR Stealth 50 2T 97-99, SR WWW 50 2T 97-01, Scarabeo 50 2T 93-05, Sonic 50 2T 98-07, Sonic GP 50 2T 98-08
Atala	Carosello 50 2T 00
Benelli	491 GT 50 2T 98-99, 491 RR 50 2T 99-01, 491 Racing 50 2T 98-99, 491 SP 50 2T 99-99, 491 ST 50 2T 99-01, 491 Sport 50 2T 98-99, K2 50 2T 98-01, K2 Liquid Cooled 50 2T 98-01, Naked 50 2T 02-02, Pepe 50 2T 99-01, Pepe LX 50 2T 03-04
Beta	Ark 50 2T 96-08, Ark LC 50 2T 96-08, Chrono 50 2T 96-00, Eikon 50 2T 99-03, Quadra 50 2T 95-00, Tempo 50 2T 95-00
Dinli	Helix DL603 50 2T 00, Helix DL603 90 50 2T 00, T-Rex 50 2T 00
E-Ton	Viper RXL 50 2T 00
Italjet	Dragster 50 2T 00
KTM	K50 50 2T 00
Keeway	ATV 50 EC2 50 2T 06-06, ATV OFF ROAD 50 2T 07-07
Laverda	Quasar 50 2T 00

Macal	Thunder 50 2T 00
Malaguti	Centro 50 2T 00, Gak 50 2T 00, Gak Euro 2.2,3 50 2T 03-03, Gak Euro 2.50 2T 01-03, Gak Master Euro 2.50 2T 06-06, F10 50 2T 00, F10 Euro 2.50 2T 00, F10 Euro 2.3 50 2T 03-04, F10 Restyling Euro 2.50 2T 06-06, F12 Phantom 50 2T 00, F12 Phantom Euro 2.50 2T 02-02, F12 Phantom Euro 2.2,3 50 2T 03-04, F12 Phantom LC 50 2T 00, F12 Phantom LC Euro 2.2,3 50 2T 03-04, F12 R Phantom LC 50 2T 07-09, F12 Restyling Euro 1.50 2T 99-02, F12 Restyling Euro 2.50 2T 06-06, F12 Restyling LC Euro 2.50 2T 06-06, F15 Firefox 50 2T 00, F15 Firefox Euro 2.50 2T 02-06, F15 Firefox Euro 2.2,3 50 2T 03-04, Yesterday 50 2T 97-00
Mbk	Evolis 50 2T 92-95, Fizz 50 2T 94-95, Flipper 50 2T 00, Flipper Euro 2.50 2T 03-03, Forte 50 2T 94-96, Mach G 50 2T 02-04, Mach G LC 50 2T 02-04, Nitro 50 2T 00, Nitro Euro 2.50 2T 03-03, Ovetto 50 2T 00, Ovetto Euro 2.50 2T 02-02
Motron	Synco 50 2T 00, Thunder 50 2T 00
Rieju	First 50 2T 00, Windy 50 2T 00
Yamaha	Aerox 50 2T 00, Aerox Euro 2.50 2T 03-03, Axis 50 2T 95-96, Breeze 50 2T 94-95, Jog 50 2T 00, Jog ER 50 2T 00, Jog R 50 2T 02-10, Jog R LC 50 2T 00, Jog Z 50 2T 95-95, Neo's 50 2T 00, Neo's Euro 2.50 2T 02-02, Why 50 2T 00, Why Euro 2.50 2T 03-03, Zest 50 2T 00, Zuma 50 2T 02-10

RICAMBI

9910500	Coppia petali in carbonio 0,30 mm
---------	-----------------------------------

9908880	Coppia petali in carbonio 0,25 mm
---------	-----------------------------------



cod. 9910930

Valvola lamellare con petali in fibra di carbonio (spessore 0,35 mm) per motore scooter 50 cc Gilera/Piaggio

APPLICABILITÀ

Aprilia Mojito 50 2T -, SR R 50 2T 04-09, SR R FACTORY Carburatore 50 2T -, SR R FACTORY IE 50 2T -, SR Street Carburatore 50 2T 03-12, Scarabeo 2T EU2 Motore Piaggio 50 2T 10-12, Scarabeo 2T Net 50 2T 09-10, Scarabeo Street 50 2T 05-06, Scarabeo Street 2T Restyling 50 2T 06-09, Sport City One 2T 50 2T 08-11

Derbi Atlantis 2T 50 2T 10-10, Atlantis 2T EU2 50 2T 07-09, Atlantis 02 50 2T 02-02, Atlantis 02 Bullet 50 2T 03-05, Atlantis 02 City 50 2T 03-06, Atlantis 02 Red Bullet 50 2T 03-03, Atlantis 02 Two Chic 50 2T 05-05, Boulevard 50 2T 09-12, GP1 50 2T 01-03, GP1 EU2 50 2T 05-05, GP1 Open EU2 50 2T 06-09, GP1 Race EU2 50 2T 05-07, Sonar 2T 50 2T 09-09

Gilera DNA 50 2T 00-02, DNA 50 2T 05-07, DNA GP Experience 50 2T 03-04, Easy Moving 50 2T 95-96, Ice 50 2T 01-05, Runner 50 2T 97-00, Runner Poggiali 50 2T 02-02, Runner Pure Jet 50 2T-IE 02-07, Runner Pure Jet 50 2T-IE 10-11, Runner Pure Jet ST 50 2T-IE 08-08, Runner SP 50 2T 02-07, Runner SP 50 2T 10-12, Runner SP ST & Simoncelli 50 2T 08-09, Runner SP Special Edition 50 2T 07-07, Stalker 50 2T 97-11, Stalker Naked 50 2T 08-08, Stalker Special Edition 50 2T 07-08, Storm 50 2T 94-95, Storm Euro 2 50 2T 07-07, Typhoon 50 2T 94-97, Typhoon X 50 2T 98-99, Typhoon XR 50 2T 00-00

Italjet
Piaggio

Jet Set 50 2T -00, Torpedo New 50 2T -00
Diesis 50 2T 01-01, Fly 2T 50 2T 05-07, Fly 2T 50 2T 10-11, Free 50 2T 92-94, Free Delivery 50 2T 00-01, Free FL 50 2T 95-02, Liberty 50 2T 97-05, Liberty 2T 50 2T 06-08, Liberty 2T PTT EU2 50 2T 04-05, Liberty 2T RST 50 2T 04-04, Liberty 2T Sport 50 2T 06-08, Liberty MOC 2T & Elle 50 2T -, NRG 50 2T 94-96, NRG Extreme 50 2T 99-00, NRG MC3 50 2T 01-04, NRG Power DD 50 2T 05-13, NRG Power DD Serie Speciale 50 2T -, NRG Power DT 50 2T 06-11, NRG Power DT Serie Speciale 50 2T 07-08, NRG Power Pure Jet 50 2T-IE 04-05, NRG Power PureJet 50 2T-IE 06-11, NRG PureJet 50 2T-IE 02-04, NRG PureJet 50 2T-IE 10-10, NRG RST MC2 50 2T 96-98, NTT 50 2T 95-96, Quartz 50 2T 92-96, Sfera 50 2T 91-93, Sfera Maquillage 2 50 2T 94-94, Sfera RST 50 2T 95-97, Typhoon 50 2T 01-11, Typhoon 2T E2 50 2T 10-12, Typhoon 2T E3 CH 50 2T 11-11, Vespa ET2 50 2T 97-05, Vespa ET2 Iniezione 50 2T 97-00, Vespa LX 2T 50 2T 05-08, Vespa LX 2T FL 50 2T 09-10, Vespa LX 2T Touring 50 2T 10-11, Vespa LXV 2T 50 2T -, Vespa LXV 2T NAVY 50 2T 08-08, Vespa S 2T & College 50 2T 07-12, Zip 50 2T 92-93, Zip 50 2T 95-96, Zip 2T 50 2T -, Zip Bimodale 50 2T 94-97, Zip Fast Rider 50 2T 93-94, Zip Fast Rider RST 50 2T 96-97, Zip LC 50 2T 00-04, Zip RST 50 2T 96-99, Zip Sp 50 2T 96-04, Zip Sp Euro 2 50 2T

RICAMBI

9911290	Coppia petali in carbonio 0,30 mm
9911300	Coppia petali in carbonio 0,35 mm



cod. 9912550

Valvola lamellare con petali in fibra di carbonio (spessore 0,30 mm) per motore scooter 50 cc Peugeot

APPLICABILITÀ

BSV Dio GP 50 2T -00, Dio SP 50 2T -00, Dio ZX 50 2T -00

HSC SC 01 50 2T -00, SC 01 L 50 2T -00

Honda Bali 50 2T 93-99, Dio SR 50 2T 92-00, Dio ZX 50 2T -00, Lead 50 2T 89-90, Met in 50 2T -00, SFX / SKR 50 2T -, SGX SKY 50 2T -, SH 50 2T -00, SH New 50 2T 96-01, Shadow 50 2T 98-01, Vision 50 2T 88-95, X8R S 50 2T 98-01, X8R X 50 2T 98-01

Kymco CX 50 2T 93-93, CX Super 50 2T 94-97, DJ World 50 2T 94-00, DJ Y 50 2T 93-93, Fever ZX 50 2T 99-00, Fever ZX EU2 50 2T 03-04, K 12 50 2T 95-00, KB 50 2T 95-00

Peugeot

Buxy 50 2T -00, Buxy RS 50 2T -00, Elyseo 50 2T -00, Looxor 50 2T -00, Metal X 50 2T -00, Metropolis 50 2T -00, Rapido 50 2T -00, ST 50 2T -00, SV Geo 50 2T -00, Speedake 50 2T -00, Speedfight 50 2T -00, Squab 50 2T -00, Trekker 50 2T -00, Vivacity 50 2T -00, X-Fight 50 2T -00, Zenith 50 2T -00

Sym

DD 50 2T 02-02

RICAMBI

9912970	Petalino in carbonio 0,30 mm
---------	------------------------------

9912980	Petalino in carbonio 0,35 mm
---------	------------------------------

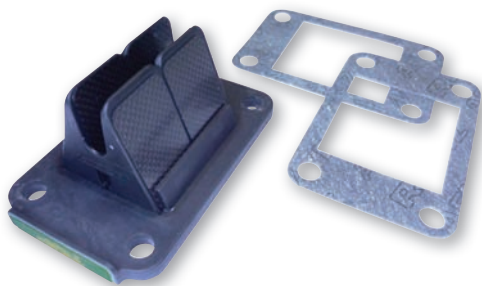

◀ **cod. 9931600** **RACING**
 Valvola lamellare TPR black ad 8 petali in carbonio (spessore 0,30 mm) per motori Minarelli AM 50 cc

APPLICABILITÀ

Aprilia Classic 50 2T 92-99, Europa 50 2T 90-92, MX 50 50 2T 04-04, MX 50 Motard 50 2T 95-03, Pegaso 50 2T 92-94, RS 50 50 2T 91-05, RX 50 50 2T 89-04, RX 50 3-5 Marce 50 2T 91-94, RX 50 Enduro 50 2T 95-03, RX 50 Racing 50 2T 03-06, Tuono 50 50 2T 03-04

Beta RR Alu 50 2T 00-, RR Enduro 50 50 2T 00-, RR Motard 50 50 2T 00

CH Husqvarna SM 50 50 2T -00, WR 50 50 2T -00, WSM 50 50 2T -00

CMC Enduro 50 50 2T 11-11, Motard 50 50 2T 11-11

Fantic Caballero Motard 50 2T 06-10, Caballero Regolarità 50 2T 06-10

HM Baja, Derapage Basic 50 2T 10-11, CMC 50 2T 10-11, CRE Baja RR, Derapage RR 50 2T 07-11, CRE Baja, Derapage 50 2T 07-11, CRE Six Competition 50 2T 10-11, CRE Six, Baia, Derapage 50 2T 95-06, CRE Six, Derapage Competition 50 2T 07-09, Derapage Competition 50 2T 10-11

Malaguti CNK Drakon 50 2T 05-07, Fifty Evolution 50 2T 90-93, XSM 50 50 2T -00, XTM 50 50 2T -00

Mbk X Limit 50 2T -00, X Power 50 2T -00

Minarelli Motor Hispania AM 345 Motori Minarelli 50 2T -00

Peugeot Furia 50 50 2T -00, Furia Max 50 50 2T -00, RX 50 50 2T -00, RX 50 R 50 2T -00

Rieju Supermotard 50 2T -00, XP6 Trail S/Avv. Elettrico 50 2T -00, XR6 Racing Cat. C/avv.elett. 50 2T -00

Sherco MRT 50 50 2T -00, MRT 50 PRO 50 2T -00, MRT 50 PRO SM 50 2T -00, MRT 50 SM 50 2T -00, MRX 50 50 2T -00, MRX 50 PRO 50 2T -00, RR 50 50 2T -00, RS1 50 50 2T -00, RS2 50 Matrix 50 2T -00, RS2 50 Matrix Pro 50 2T -00, RS2 Naked 50 50 2T -00, SMX 50 E.S./K.S. 50 2T -00, SMX 50 PRO E.S./K.S. 50 2T -00, Spike 50 50 2T -00

Yamaha HRD Enduro 50 50 2T -00, HRD Motard 50 50 2T -00, DT R 50 2T 03-10, DT RSM 50 2T 03-05, DT X 50 2T 06-10, TZR 50 2T 03-08, TZR 50 2T 10-11, TZR RR 50 2T 05-05

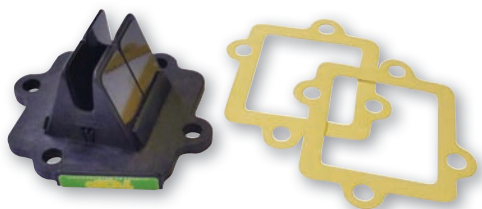

◀ **cod. 9931620** **RACING**
 Valvola lamellare TPR black ad 8 petali in carbonio (spessore 0,30 mm) per motori scooter 50 cc Minarelli/Yamaha orizzontale

APPLICABILITÀ

Aprilia Area 51 50 2T 98-00, Gulliver 50 2T 95-98, Gulliver LC 50 2T 96-98, Rally 50 2T 95-03, Rally Liquid Cooled 50 2T 96-99, SR (Orizzontale) 50 2T 94-96, SR Liquid Cooled 50 2T 94-96, SR Racing 50 2T 97-99, SR Stealth 50 2T 97-99, SR WWW 50 2T 97-01, Scarabeo 50 2T 93-05, Sonic 50 2T 98-07, Sonic GP 50 2T 98-08

Atala Carosello 50 2T -00

Benelli 491 GT 50 2T 98-99, 491 RR 50 2T 99-01, 491 Racing 50 2T 98-99, 491 SP 50 2T 99-99, 491 ST 50 2T 99-01, 491 Sport 50 2T 98-99, K2 50 2T 98-01, K2 Liquid Cooled 50 2T 98-01, Naked 50 2T 02-02, Pepe 50 2T 99-01, Pepe 50 2T 10-10, Pepe LX 50 2T 03-04, Pepe LX 50 2T 07-09, Pepe Old 50 2T 07-09, Pepe Old 50 2T 11-11, Quattro-nonex 50 2T 08-11

Beta Ark 50 2T 96-08, Ark LC 50 2T 96-08, Chrono 50 2T 96-00, Eikon 50 2T 99-03, Quadra 50 2T 95-00, Tempo 50 2T 95-00

CPI Aragon 50 2T 03-03, Hussar 50 2T 03-03, Oliver 50 2T 03-03, Pop Corn 50 2T 03-03

Explorer Cracker 50 2T 03-03

Italjet Dragster 50 2T -00

KTM K50 50 2T -00

Keeway F-Act 50 2T 07-08, Flash 50 2T 07-08, Focus 50 2T 06-06, Goccia 50 2T 09-09, Hurricane 50 2T 06-08, Matrix 50 2T 06-08, Pixel Euro 2 50 2T -00, RY8 50 2T 08-08

Macal Thunder 50 2T -00

Malaguti Centro 50 2T -00, Ciak 50 2T -00, Ciak Euro 2, 2,3 50 2T 03-03, Ciak Euro2 50 2T 01-03, Ciak Master Euro 2 50 2T 06-06, F10 50 2T -00, F10 Euro 2 50 2T -00, F10 Euro 2, 2,3 50 2T 03-04, F10 Restyling Euro 2 50 2T 06-06, F10 Wap Euro 2 50 2T -00, F12 Phantom 50 2T -00, F12 Phantom Euro 2 50 2T 02-02, F12 Phantom Euro 2, 2,3 50 2T 03-04, F12 Phantom LC 50 2T -00, F12 Phantom LC Euro 2, 2,3 50 2T 03-04, F12 R Phantom 50 2T 07-07, F12 R Phantom LC 50 2T 07-09, F12 Restyling Euro 1 50 2T 99-02, F12 Restyling Euro 2 50 2T 06-06, F12 Restyling LC Euro 2 50 2T 06-06, F15 Firefox 50 2T -00, F15 Firefox Euro 2 50 2T 02-06, F15 Firefox Euro 2, 2,3 50 2T 03-04, Yesterday 50 2T 97-00

Mbk Evolis 50 2T 92-95, Fizz 50 2T 94-95, Flipper 50 2T -00, Flipper Euro 2 50 2T 03-03, Forte 50 2T 94-96, Mach G 50 2T 02-04, Mach G LC 50 2T 02-04, Nitro 50 2T -00, Nitro Euro 2 50 2T 03-03, Ovetto 50 2T -00, Ovetto Euro 2 50 2T 02-02

Motron Syncro 50 2T -00, Thunder 50 2T -00

Rieju First 50 2T -00, Windy 50 2T -00

Yamaha Aerox 50 2T -00, Aerox Euro 2 50 2T 03-03, Axis 50 2T 95-96, Breeze 50 2T 94-95, Jog 50 2T -00, Jog R 50 2T 02-10, Jog R LC 50 2T -00, Neo's 50 2T -00, Neo's Euro 2 50 2T 02-02, Why 50 2T -00, Why Euro 2 50 2T 03-03, Zest 50 2T -00

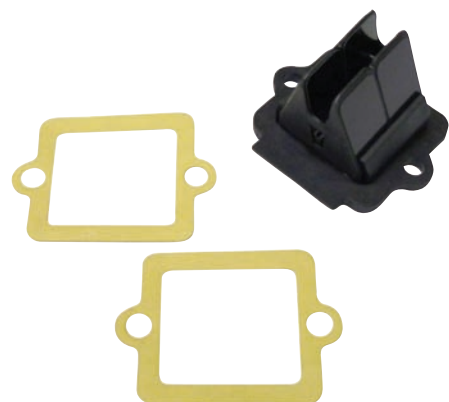

◀ **cod. 9931640** **RACING**
 Valvola lamellare TPR black ad 8 petali in carbonio (spessore 0,30 mm) per motori scooter 50 cc Piaggio/Gilera

APPLICABILITÀ

Aprilia Mojito 50 2T -, SR R 50 2T 04-09, SR R FACTORY Carburatore 50 2T -, SR R FACTORY IE 50 2T -, SR Street Carburatore 50 2T 03-12, Scarabeo 2T EU2 Motore Piaggio 50 2T 10-12, Scarabeo 2T Net 50 2T 09-10, Scarabeo Street 50 2T 05-06, Scarabeo Street 2T Restyling 50 2T 06-09, Sport City One 2T 50 2T 08-11

Derbi Atlantis 2T 50 2T 10-10, Atlantis 2T EU2 50 2T 07-09, Atlantis O2 50 2T 02-02, Atlantis O2 Bullet 50 2T 03-05, Atlantis O2 City 50 2T 03-06, Atlantis O2 Red Bullet 50 2T 03-03, Atlantis O2 Two Chic 50 2T 05-05, Boulevard 50 2T 09-12, GP1 50 2T 01-03, GP1 EU2 50 2T 05-05, GP1 Open EU2 50 2T 06-09, GP1 Race EU2 50 2T 05-07, Sonar 2T 50 2T 09-09

Gilera DNA 50 2T 00-02, DNA 50 2T 05-07, DNA GP Experience 50 2T 03-04, Easy Moving 50 2T 95-96, Ice 50 2T 01-05, Runner 50 2T 97-00, Runner Poggiali 50 2T 02-02, Runner Pure Jet 50 2T-IE 02-07, Runner Pure Jet 50 2T-IE 10-11, Runner Pure Jet 50 2T-IE 08-08, Runner SP 50 2T 02-07, Runner SP 50 2T 10-12, Runner SP ST & Simoncelli 50 2T 08-09, Runner SP Special Edition 50 2T 07-07, Stalker 50 2T 97-11, Stalker Naked 50 2T 08-08, Stalker Special Edition 50 2T 07-08, Storm 50 2T 94-95, Storm Euro 2 50 2T 07-07, Typhoon 50 2T 94-97, Typhoon X 50 2T 98-99, Typhoon XR 50 2T 00-00

Italjet Jet Set 50 2T -00, Torpedo New 50 2T -00

Piaggio Diesis 50 2T 01-01, Fly 2T 50 2T 05-07, Fly 2T 50 2T 10-11, Free 50 2T 92-94, Free Delivery 50 2T 00-01, Free FL 50 2T 95-02, Liberty 50 2T 97-05, Liberty 2T 50 2T 06-08, Liberty 2T PTT EU2 50 2T 04-05, Liberty 2T RST 50 2T 04-04, Liberty 2T Sport 50 2T 06-08, Liberty MOC 2T & Elle 50 2T -, NRG 50 2T 94-96, NRG Extreme 50 2T 99-00, NRG MC3 50 2T 01-04, NRG Power DD 50 2T 05-13, NRG Power DD Serie Speciale 50 2T -, NRG Power DT 50 2T 06-11, NRG Power DT Serie Speciale 50 2T 07-08, NRG Power Pure Jet 50 2T-IE 04-05, NRG Power PureJet 50 2T-IE 06-11, NRG PureJet 50 2T-IE 02-04, NRG PureJet 50 2T-IE 10-10, NRG RST MC2 50 2T 96-98, NTT 50 2T 95-96, Quartz 50 2T 92-96, Sfera 50 2T 91-93, Sfera Maquillage 2 50 2T 94-94, Sfera RST 50 2T 95-97, Typhoon 50 2T 01-11, Typhoon 2T E2 50 2T 10-12, Typhoon 2T E3 CH 50 2T 11-11, Vespa ET2 50 2T 97-05, Vespa ET2 iniezione 50 2T 97-00, Vespa LX 2T 50 2T 05-08, Vespa LX 2T FL 50 2T 09-10, Vespa LX 2T Touring 50 2T 10-11, Vespa LXV 2T 50 2T -, Vespa LXV 2T NAVY 50 2T 08-08, Vespa S 2T & Collese 50 2T 07-12, Zip 50 2T 92-93, Zip 50 2T 95-96, Zip 2T 50 2T -, Zip Bimodale 50 2T 94-97, Zip Fast Rider 50 2T 93-94, Zip Fast Rider RST 50 2T 96-97, Zip LC 50 2T 00-04, Zip RST 50 2T 96-99, Zip Sp 50 2T 96-04, Zip Sp Euro 2 50 2T

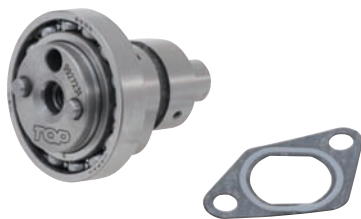

◀ **cod. 9927230**
Kit albero a camme per motori Minarelli/Yamaha 125 4v

APPLICABILITÀ

Beta RR 125 4T-4V 10-10

Fantic Caballero Motard 125 4T-4V 08-08, Caballero Regolarità 125 4T-4V 08-08

HM City 125 4T-4V 11-13, Cre F125x 125 4T-4V 08-09, Cre F125x Baja 125 4T-4V 10-12, Cre F125x Baja Rr 125 4T-4V 10-12, Cre F125x Six 125 4T-4V 10-11, Crm F125x 125 4T-4V 08-09, Crm F125x Derapage 125 4T-4V 10-12, Crm F125x Derapage Competition 125 4T-4V 10-11, Crm F125x Derapage Rr 125 4T-4V 10-12, Locusta 125 4T-4V 11-13, City 200 4T-4V 11-13, Locusta 200 4T-4V 11-13

Husqvarna SM 125 4T-4V 10-10, TE 125 4T-4V 10-10

Mbk Cityliner 125 EU3 125 4T-4V 08-10, Skycruiser 125 125 4T-4V 07-07

Motor KN1 125 4T-4V 08-08, MH7 125 4T-4V 08-08, RX-R 125 4T-4V 08-08

Hispania Marathon 125 4T-4V 09-09, Marathon Pro 125 4T-4V 09-09, Marathon Pro Competition 125 4T-4V 11-11, RS3 125 4T-4V 11-11

Rieju

Yamaha MT 125 125 4T 4V IE 15-15, MT 125 A 125 4T 4V IE 15-15, WR-R IE 125 4T 4V IE 09-11, WR-X IE 125 4T 4V IE 09-11, WR-X IE 125 4T 4V IE 13-14, X-City 125 EU3 125 4T-4V 08-11, X-Max R 125 125 4T-4V 06-16, X-Max R 125 ABS 125 4T-4V 11-11, X-Max RA 125 ABS 125 4T-4V 13-16, YZF-R A IE 125 4T 4V IE 15-15, YZF-R IE 125 4T 4V IE 08-15



◀ **cod. 9928160**
Albero a camme Yamaha YZF 125 R per kit 183 cc

APPLICABILITÀ

Yamaha YZF-R IE 125 4T 4V IE 08-13



◀ Pignoni catena per motori Minarelli AM6

		Z12	Z14
1/2" x 3/16" x 7,75	per catena 415	9918470	9917930
1/2" x 1/4" x 7,75	per catena 420	9918490	9917980
1/2" x 5/16" x 8,51	per catena 428		

◀ cod. 9919080

RACING

Ingranaggio 6 velocità Ø18 su albero primario Z=26 per motori Minarelli AM6 1° SERIE

APPLICABILITÀ

Aprilia	Classic 50 2T 92-99, MX 50 50 2T 04-04, MX 50 Motard 50 2T 95-03, RS 50 50 2T 93-05, RX 50 50 2T 03-04, RX 50 Enduro 50 2T 95-03, Tuono 50 50 2T 03-04	Malaguti	CNK Drakon 50 2T 05-07, XSM 50 50 2T -00, XTM 50 50 2T -00
Beta	RR Alu 50 2T 00-, RR Enduro 50 50 2T 00-, RR Motard 50 50 2T 00	Mbk	X Limit 50 2T -00, X Power 50 2T -00
CH Husqvarna	SM 50 50 2T -00, WR 50 50 2T -00, WSM 50 50 2T -00	Motor Hispania	Furia 50 50 2T -00, Furia Max 50 50 2T -00, RX 50 50 2T -00, RX 50 R 50 2T -00
CMC	Enduro 50 50 2T 11-11, Motard 50 50 2T 11-11	Peugeot	Supermotard 50 2T -00, XP6 Trail S/Avv. Elettrico 50 2T -00, XR6 Racing Cat. C/avv.elett. 50 2T -00
Fantic	Caballero Motard 50 2T 06-10, Caballero Regolarità 50 2T 06-10	Rieju	Mrt 50 50 2T -00, Mrt 50 Pro 50 2T -00, Mrt 50 Pro Sm 50 2T -00, Mrt 50 Sm 50 2T -00, Mrx 50 50 2T -00, Mrx 50 Pro 50 2T -00, Rr 50 50 2T -00, Rr 50 50 2T -00, Rr 50 Matrix 50 2T -00, Rr 50 Matrix Pro 50 2T -00, Rr 50 Naked 50 50 2T -00, Smx 50 E.S./K.S. 50 2T -00, Smx 50 Pro E.S./K.S. 50 2T -00, Spike 50 50 2T -00
HM	Baja, Derapage Basic 50 2T 10-11, CMC 50 2T 10-11, CRE Baja RR, Derapage RR 50 2T 07-11, CRE Baja, Derapage 50 2T 07-11, CRE Six Competition 50 2T 10-11, CRE Six, Baia, Derapage 50 2T 95-06, CRE Six, Derapage Competition 50 2T 07-09, Derapage Competition 50 2T 10-11	Sherco	HRD Enduro 50 50 2T -00, HRD Motard 50 50 2T -00
		Yamaha	Dt R 50 2T 03-10, Dt Rsm 50 2T 03-05, Dt X 50 2T 06-10, Tzr 50 2T 03-08, Tzr 50 2T 10-10, Tzr Rr 50 50 2T 05-05

◀ cod. 9931910

Ingranaggio 6° velocità Ø20 su albero primario Z=26 per motori Minarelli AM6 2° serie

APPLICABILITÀ

Aprilia	Classic 50 2T 92-99, MX 50 50 2T 04-04, MX 50 Motard 50 2T 95-03, RS 50 50 2T 93-05, RX 50 50 2T 03-04, RX 50 Enduro 50 2T 95-03, Tuono 50 50 2T 03-04	Malaguti	CNK Drakon 50 2T 05-07, XSM 50 50 2T -00, XTM 50 50 2T -00
Beta	RR Alu 50 2T 00-, RR Enduro 50 50 2T 00-, RR Motard 50 50 2T 00	Mbk	X Limit 50 2T -00, X Power 50 2T -00
CH Husqvarna	SM 50 50 2T -00, WR 50 50 2T -00, WSM 50 50 2T -00	Motorhispania	Furia 50 50 2T -00, Furia Max 50 50 2T -00, RX 50 50 2T -00, RX 50 R 50 2T -00
CMC	Enduro 50 50 2T 11-11, Motard 50 50 2T 11-11	Peugeot	Supermotard 50 2T -00, XP6 Trail S/Avv. Elettrico 50 2T -00, XR6 Racing Cat. C/avv.elett. 50 2T -00
Fantic	Caballero Motard 50 2T 06-10, Caballero Regolarità 50 2T 06-10	Rieju	MRT 50 50 2T -00, MRT 50 PRO 50 2T -00, MRT 50 PRO SM 50 2T -00, MRT 50 SM 50 2T -00, MRX 50 50 2T -00, MRX 50 PRO 50 2T -00, Rr 50 50 2T -00, Rr 50 50 2T -00, Rr 50 Matrix 50 2T -00, Rr 50 Matrix Pro 50 2T -00, Rr 50 Naked 50 50 2T -00, Smx 50 E.S./K.S. 50 2T -00, Smx 50 PRO E.S./K.S. 50 2T -00, Spike 50 50 2T -00
HM	Baja, Derapage Basic 50 2T 10-11, CMC 50 2T 10-11, CRE Baja RR, Derapage RR 50 2T 07-11, CRE Baja, Derapage 50 2T 07-11, CRE Six Competition 50 2T 10-11, CRE Six, Baia, Derapage 50 2T 95-06, CRE Six, Derapage Competition 50 2T 07-09, Derapage Competition 50 2T 10-11	Sherco	HRD Enduro 50 50 2T -00, HRD Motard 50 50 2T -00
		Yamaha	Dt R 50 2T 03-10, Dt Rsm 50 2T 03-05, Dt X 50 2T 06-10, Tzr 50 2T 03-08, Tzr 50 2T 10-10, Tzr Rr 50 50 2T 05-05

◀ cod. 9920020

RACING

Desmodromico cambio in "ERGA 55" per motori Minarelli AM6

APPLICABILITÀ

Aprilia	Classic 50 2T 92-99, MX 50 50 2T 04-04, RS 50 50 2T 93-05, RX 50 50 2T 03-04, Tuono 50 50 2T 03-04	Motor Hispania	Furia 50 50 2T -00, Furia Max 50 50 2T -00, RX 50 50 2T -00, RX 50 R 50 2T -00
Beta	RR Alu 50 2T 00-, RR Enduro 50 50 2T 00-, RR Motard 50 50 2T 00	Peugeot	Supermotard 50 2T -00, XP6 Trail S/Avv. Elettrico 50 2T -00, XR6 Racing Cat. C/avv.elett. 50 2T -00
CH Husqvarna	SM 50 50 2T -00, WR 50 50 2T -00, WSM 50 50 2T -00	Rieju	Mrt 50 50 2T -00, Mrt 50 Pro 50 2T -00, Mrt 50 Pro Sm 50 2T -00, Mrt 50 Sm 50 2T -00, Mrx 50 50 2T -00, Mrx 50 Pro 50 2T -00, Rr 50 50 2T -00, Rr 50 50 2T -00, Rr 50 Matrix 50 2T -00, Rr 50 Matrix Pro 50 2T -00, Rr 50 Naked 50 50 2T -00, Smx 50 E.S./K.S. 50 2T -00, Smx 50 Pro E.S./K.S. 50 2T -00, Spike 50 50 2T -00
CMC	Enduro 50 50 2T 11-11, Motard 50 50 2T 11-11	Sherco	HRD Enduro 50 50 2T -00, HRD Motard 50 50 2T -00
Fantic	Caballero Motard 50 2T 06-10, Caballero Regolarità 50 2T 06-10	Yamaha	Dt R 50 2T 03-10, Dt Rsm 50 2T 03-05, Dt X 50 2T 06-10, Tzr 50 2T 03-08, Tzr 50 2T 10-10, Tzr Rr 50 50 2T 05-05
HM	Baja, Derapage Basic 50 2T 10-11, CMC 50 2T 10-11, CRE Baja RR, Derapage RR 50 2T 07-11, CRE Baja, Derapage 50 2T 07-11, CRE Six Competition 50 2T 10-11, CRE Six, Baia, Derapage 50 2T 95-06, CRE Six, Derapage Competition 50 2T 07-09, Derapage Competition 50 2T 10-11		
Malaguti	CNK Drakon 50 2T 05-07, XSM 50 50 2T -00, XTM 50 50 2T -00		
Mbk	X Limit 50 2T -00, X Power 50 2T -00		



◀ **cod. 9913300**
Rapporti primari allungati
Z= 15/50 Rapporto 1:3,33

APPLICABILITÀ

Aprilia Amico 50 2T 94-94, Amico 50 2T 96-98, Amico GL/GLE 50 2T 93-95, Amico LX/Sport/Cat 50 2T 92-93, Area 51 50 2T 98-00, Gulliver 50 2T 95-98, Gulliver LC 50 2T 96-98, Rally 50 2T 95-03, Rally Liquid Cooled 50 2T 96-99, SR (Orizzontale) 50 2T 94-96, SR (Verticale) 50 2T 93-93, SR Liquid Cooled 50 2T 94-96, SR Recing 50 2T 97-99, SR Stealth 50 2T 97-99, SR WWW 50 2T 97-01, Scarabeo 50 2T 93-05

Atala Carosello 50 2T-00

Benelli 91 GT 50 2T 98-99, 491 RR 50 2T 99-01, 491 Racing 50 2T 98-99, 491 SP 50 2T 99-99, 491 ST 50 2T 99-01, 491 Sport 50 2T 98-99, K2 50 2T 98-01, K2 Liquid Cooled 50 2T 98-01, Naked 50 2T 02-02, Pepe 50 2T 99-01, Pepe LX 50 2T 03-04

Beta Ark 50 2T 96-08, Ark LC 50 2T 96-08, Chrono 50 2T 96-00, Eikon 50 2T 99-03, Quadra 50 2T 95-00, Tempo 50 2T 95-00

Italjet Dragster 50 2T-00

KTM K50 50 2T-00

Macal Thunder 50 2T-00

Malaguti Centro 50 2T-00, Ciak 50 2T-00, Ciak Euro 2, 2,3 50 2T 03-03, Ciak Euro2 50 2T 01-03, Ciak Master Euro 2 50 2T 06-06, F12 Phantom 50 2T-00, F12 Phantom Euro 2, 2,3 50 2T 03-04, F12 Phantom LC 50 2T-00, F12 R Phantom LC 50 2T 07-09, F12 Restyling Euro 2 50 2T 06-06, F15 Firefox 50 2T-00, F15 Firefox Euro 2 50 2T 02-06, F15 Firefox Euro 2, 2,3 50 2T 03-04

Mbk Booster 50 2T-00, Booster Euro 2 50 2T 04-04, Booster NG 50 2T 03-00, Booster Rocket 50 2T 97-98, Booster Spirit 50 2T 03-00, Booster Track 50 2T 96-98, Flipper 50 2T-00, Flipper Euro 2 50 2T 03-03, Mach G 50 2T 02-04, Mach G LC 50 2T 02-04, Nitro 50 2T-00, Nitro Euro 2 50 2T 03-03, Ovetto 50 2T-00, Ovetto Euro 2 50 2T 02-02, Stunt 50 2T 00-02

Motron Syncro 50 2T-00, Thunder 50 2T-00

Rieju First 50 2T-00, Windy 50 2T-00

Yamaha Aerox 50 2T-00, Aerox Euro 2 50 2T 03-03, BWS 50 2T-00, BWS Bump 50 2T 97-98, BWS Euro 2 50 2T 03-03, BWS NG 50 2T-00, BWS NG Euro 2 50 2T 03-03, Jog R 50 2T 02-10, Jog R LC 50 2T-00, Neo's 50 2T-00, Neo's Euro 2 50 2T 02-02, Slider 50 2T 00-02, Spy 50 2T 95-98, Why 50 2T-00, Why Euro 2 50 2T 03-03, Zuma 50 2T 97-01



◀ **cod. 9913310**
Rapporti primari allungati
Z= 14/46 Rapporto 1:3,28

APPLICABILITÀ

Aprilia Sonic 50 2T 98-07, Sonic GP 50 2T 98-08

Macal Sting 50 2T-00

Malaguti F10 50 2T-00, F10 Euro 2 50 2T-00, F10 Euro 2, 2,3 50 2T 03-04, F10 Restyling Euro 2 50 2T 06-06, Yesterday 50 2T 97-00

Mbk Evolis 50 2T 92-95, Fizz 50 2T 94-95, Forte 50 2T 94-96

Motron Sting 50 2T-00

Yamaha Axis 50 2T 95-96, Breeze 50 2T 94-95, Jog 50 2T-00, Jog ER 50 2T-00, Jog Z 50 2T 95-95, Zest 50 2T-00



◀ **cod. 9909520**
Rapporti secondari allungati
Z= 15/41 Rapporto 1:2,73

APPLICABILITÀ

Aprilia Area 51 50 2T 98-00, Gulliver LC 50 2T 96-98, Rally Liquid Cooled 50 2T 96-99, SR (Orizzontale) 50 2T 94-96, SR Liquid Cooled 50 2T 94-96, SR Recing 50 2T 97-99, SR Stealth 50 2T 97-99

Benelli 491 GT 50 2T 98-99, 491 RR 50 2T 99-01, 491 Racing 50 2T 98-99, 491 SP 50 2T 99-99, 491 ST 50 2T 99-01, 491 Sport 50 2T 98-99, Pepe 50 2T 99-01, Pepe LX 50 2T 03-04

Beta Ark LC 50 2T 96-08, Eikon 50 2T 99-03

Italjet Dragster 50 2T-00

Malaguti F12 Phantom 50 2T-00, F12 Phantom Euro 2, 2,3 50 2T 03-04, F12 Phantom LC 50 2T-00, F12 Phantom LC Euro 2, 2,3 50 2T 03-04, F12 R Phantom LC 50 2T 07-09, F12 Restyling Euro 2 50 2T 06-06, F15 Firefox 50 2T-00, F15 Firefox Euro 2 50 2T 02-06, F15 Firefox Euro 2, 2,3 50 2T 03-04

Mbk Booster NG 50 2T 03-00, Mach G LC 50 2T 02-04, Nitro 50 2T-00, Nitro Euro 2 50 2T 03-03, Stunt 50 2T 00-02

Yamaha Aerox 50 2T-00, Aerox Euro 2 50 2T 03-03, BWS NG 50 2T-00, BWS NG Euro 2 50 2T 03-03, Jog R LC 50 2T-00, Slider 50 2T 00-02, Spy 50 2T 95-98, Why 50 2T-00, Why Euro 2 50 2T 03-03

◀ **cod. 990875P**
Rapporti secondari allungati
Z= 16/41 Rapporto 1:2,56

APPLICABILITÀ

Aprilia Area 51 50 2T 98-00, Gulliver 50 2T 95-98, Gulliver LC 50 2T 96-98, Rally 50 2T 95-03, Rally Liquid Cooled 50 2T 96-99, SR (Orizzontale) 50 2T 94-96, SR (Verticale) 50 2T 93-93, SR Liquid Cooled 50 2T 94-96, SR Recing 50 2T 97-99, SR Stealth 50 2T 97-99, SR WWW 50 2T 97-01

Atala Carosello 50 2T-00

Benelli 491 GT 50 2T 98-99, 491 RR 50 2T 99-01, 491 Racing 50 2T 98-99, 491 SP 50 2T 99-99, 491 ST 50 2T 99-01, 491 Sport 50 2T 98-99, K2 50 2T 98-01, K2 Liquid Cooled 50 2T 98-01, Naked 50 2T 02-02, Pepe 50 2T 99-01, Pepe LX 50 2T 03-04

Beta Ark 50 2T 96-08, Ark LC 50 2T 96-08, Chrono 50 2T 96-00, Eikon 50 2T 99-03, Quadra 50 2T 95-00, Tempo 50 2T 95-00

Italjet Dragster 50 2T-00

KTM K50 50 2T-00

Macal Thunder 50 2T-00

Malaguti Centro 50 2T-00, F12 Phantom 50 2T-00, F12 Phantom Euro 2 50 2T 02-02, F12 Phantom Euro 2, 2,3 50 2T 03-04, F12 Phantom LC 50 2T-00, F12 Phantom LC Euro 2, 2,3 50 2T 03-04, F12 R Phantom LC 50 2T 07-09, F12 Restyling Euro 1 50 2T 99-02, F12 Restyling Euro 2 50 2T 06-06, F12 Restyling LC Euro 2 50 2T 06-06, F15 Firefox 50 2T-00, F15 Firefox Euro 2 50 2T 02-06, F15 Firefox Euro 2, 2,3 50 2T 03-04

Mbk Booster 50 2T-00, Booster Euro 2 50 2T 04-04, Booster NG 50 2T 03-00, Booster Rocket 50 2T 97-98, Booster Spirit 50 2T 03-00, Booster Track 50 2T 96-98, Mach G 50 2T 02-04, Mach G LC 50 2T 02-04, Nitro 50 2T-00, Nitro Euro 2 50 2T 03-03, Ovetto 50 2T-00, Ovetto Euro 2 50 2T 02-02, Stunt 50 2T 00-02

Motron Syncro 50 2T-00, Thunder 50 2T-00

Rieju First 50 2T-00, Windy 50 2T-00

Yamaha Aerox 50 2T-00, Aerox Euro 2 50 2T 03-03, BWS 50 2T-00, BWS Bump 50 2T 97-98, BWS Euro 2 50 2T 03-03, BWS NG 50 2T-00, BWS NG Euro 2 50 2T 03-03, Jog R 50 2T 02-10, Jog R LC 50 2T-00, Neo's 50 2T-00, Neo's Euro 2 50 2T 02-02, Slider 50 2T 00-02, Spy 50 2T 95-98, Zuma 50 2T 97-01

◀ **cod. 990902P**
Rapporti secondari allungati
Z= 15/34 Rapporto 1:2,27

APPLICABILITÀ

Aprilia Sonic 50 2T 98-07, Sonic GP 50 2T 98-08

Macal Sting 50 2T-00

Malaguti F10 50 2T-00, F10 Euro 2 50 2T-00, F10 Euro 2, 2,3 50 2T 03-04, F10 Restyling Euro 2 50 2T 06-06, Yesterday 50 2T 97-00

Mbk Evolis 50 2T 92-95, Fizz 50 2T 94-95, Forte 50 2T 94-96

Motron Sting 50 2T-00

Yamaha Axis 50 2T 95-96, Breeze 50 2T 94-95, Jog 50 2T-00, Jog ER 50 2T-00, Jog Z 50 2T 95-95, Zest 50 2T-00



◀ **cod. 9921280**
Albero motore competizione corsa 40,2 mm con ralle
 Per motore scooter 50cc Minarelli/Yamaha tipo orizzontale A.C. e L.C.

RICAMBI

9914540	Gabbia a rulli	9921410	Biella completa
---------	----------------	---------	-----------------



◀ **cod. 9921720** **RACING**
Albero motore corsa 39 mm a piattelli pieni per motori Minarelli AM6

APPLICABILITÀ

Aprilia	Classic 50 2T 92-99, Europa 50 2T 91-92, MX 50 50 2T 04-04, MX 50 Motard 50 2T 95-03, Pegaso 50 2T 92-94, RS 50 50 2T 91-05, RX 50 50 2T 03-04, RX 50 3-5 Marce 50 2T 91-94, RX 50 Enduro 50 2T 95-03, RX 50 Racing 50 2T 03-06, Tuono 50 50 2T 03-04	Malaguti	CNK Drakon 50 2T 05-07, Fifty Evolution 50 2T 90-93, XSM 50 50 2T -00, XTM 50 50 2T -00
Beta	RR Alu 50 2T 00-, RR Enduro 50 50 2T 00-, RR Motard 50 50 2T 00	Mbk	X Limit 50 2T -00, X Power 50 2T -00
CH	SM 50 50 2T -00, WR 50 50 2T -00, WSM 50 50 2T -00	Minarelli Motor	AM 345 Motori Minarelli 50 2T -00
Husquarna		Hispania	Furia 50 50 2T -00, Furia Max 50 50 2T -00, RX 50 50 2T -00, RX 50 R 50 2T -00
CMC	Enduro 50 50 2T 11-11, Motard 50 50 2T 11-11	Peugeot	Supermotard 50 2T -00, XP6 Trail S/Avv. Elettrico 50 2T -00, XR6 Racing Cat. C/avv.elett. 50 2T -00
Fantic	Caballero Motard 50 2T 06-10, Caballero Regolarità 50 2T 06-10	Rieju	Mrt 50 50 2T -00, Mrt 50 Pro 50 2T -00, Mrt 50 Pro Sm 50 2T -00, Mrt 50 Sm 50 2T -00, Mrx 50 50 2T -00, Mrx 50 Pro 50 2T -00, Rr 50 50 2T -00, Rs1 50 50 2T -00, Rs2 50 Matrix 50 2T -00, Rs2 50 Matrix Pro 50 2T -00, Rs2 Naked 50 50 2T -00, Smx 50 E.S./K.S. 50 2T -00, Smx 50 Pro E.S./K.S. 50 2T -00, Spike 50 50 2T -00
HM	Baja, Derapage Basic 50 2T 10-11, CMC 50 2T 10-11, CRE Baja RR, Derapage RR 50 2T 07-11, CRE Baja, Derapage 50 2T 07-11, CRE Six Competition 50 2T 10-11, CRE Six, Baia, Derapage 50 2T 95-06, CRE Six, Derapage Competition 50 2T 07-09, Derapage Competition 50 2T 10-11	Sherco	HRD Enduro 50 50 2T -00, HRD Motard 50 50 2T -00
		Yamaha	Dt R 50 2T 03-10, Dt Rsm 50 2T 03-05, Dt X 50 2T 06-10, Tzr 50 2T 03-08, Tzr 50 2T 10-11, Tzr Rr 50 2T 05-05

RICAMBI

9924750	Kit cuscinetti paraoli banco	IM07036	Biella
9921330	Gabbia a rulli		



◀ **cod. 9925910** **RACING**
Albero motore completo "TPR" corsa 39,2 spinotto ø 10 per motore scooter 50 cc Minarelli/Yamaha tipo orizzontale con cuscinetti

RICAMBI

9914540	Gabbia a rulli	9925920	Biella spinotto ø 10
KK01002	Kit cuscinetti e paraoli		



◀ **cod. 9926180** **RACING**
Albero motore completo "TPR" corsa 39,3 spinotto ø 12 Per motore scooter 50cc Piaggio/Gilera con cuscinetti

RICAMBI

9907820	Gabbia a rulli	9926190	Biella spinotto ø 12
KK01009	Kit cuscinetti e paraoli		



cod. **9927900** **RACING**
 Albero motore completo "TPR" corsa 39,2 spinotto \varnothing 10 per motore scooter
 50cc Minarelli/Yamaha tipo verticale con cuscinetti

RICAMBI

9914540	Gabbia a rulli
KK01002	Kit cuscinetti paraoli

9925920	Biella spinotto \varnothing 10
---------	----------------------------------



cod. **9928320** **RACING**
 Albero motore completo "TPR" corsa 39,2 spinotto \varnothing 12 per motore scooter 50cc
 Minarelli/Yamaha tipo orizzontale con cuscinetti

RICAMBI

9907820	Gabbia a rulli
KK01002	Kit cuscinetti paraoli

9929490	Biella spinotto \varnothing 12
---------	----------------------------------



cod. **9929180** **RACING**
 Cuscinetti ad alte prestazioni con sfere maggiorate e anelli carbonitrurati ad elevata scorrevolezza
 Serie 2 cuscinetti | Misure: 17 x 47 x 14 | Sigla: 6303ETN9HN1C3H | Adattabile a motori Minarelli AM345/6

cod. **9929190** **RACING**
 Cuscinetti ad alte prestazioni con sfere maggiorate e anelli carbonitrurati ad elevata scorrevolezza
 Serie 2 cuscinetti | Misure: 20 x 47 x 14 | Sigla: 6204ETN9HN1C3H | Adattabile a motori scooter 50cc Minarelli/Yamaha

cod. **9929300** **RACING**
 Cuscinetti ad alte prestazioni con sfere maggiorate e anelli carbonitrurati ad elevata scorrevolezza
 Serie 2 cuscinetti | Misure: 17 x 47 x 14 - 20 x 47 x 14 | Adattabile ad alberi motore TPR cod. 9920410 - 9921720



cod. **9929200** **RACING**
 Cuscinetti ad alte prestazioni con sfere maggiorate e anelli carbonitrurati ad elevata scorrevolezza
 Serie 2 cuscinetti | Misure: 20 x 52 x 12 | Sigla: BB1BB1447205AHN1
 Adattabile a motori scooter 50cc. Piaggio/Gilera/Derbi



◀ cod. **9927100**

Gruppo termico Ø 39,885 Derbi Senda (d50b0) motore Piaggio

Cilindro in ghisa Minacrom con 7 travasi | Cilindrata 49,93cc - Corsa mm 40 - Rapp. Comp. 1:13,8 | Completo di testa

RICAMBI

9927000	Pistone completo Ø 39,88
9927001	Pistone completo Ø 40,28
9930230	Serie segmenti Ø39,88
9930231	Serie segmenti Ø 40,28
9930240	Serie guarnizioni

9930220	Testa
9928090	Raccordo testa
9929480	Serie prigionieri M7 x 115
9930270	Tappo cilindrico



◀ cod. **9914500**

Gruppo termico Ø 40 adattabile a motori Gilera/Piaggio air cooled

Cilindro in ghisa Minacrom con 5 travasi | Cilindrata 49,3cc - Corsa mm 39,3 - Rapp. Comp. 1:12 | Completo di testa

RICAMBI

9913470	Pistone completo ø 40
9913471	Pistone completo ø 40,5
9913472	Pistone completo ø 41
9910380	Serie segmenti ø 40

9910381	Serie segmenti ø 40,5
9914710	Guarnizione base
9910750	Testa troncoconica

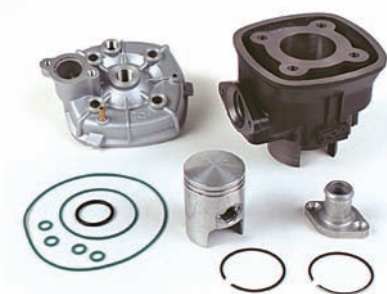

◀ cod. **9916580**

Gruppo termico Ø 40 adattabile a motori Gilera/Piaggio liquid cooled con raccordo testa

Cilindro in ghisa Minacrom con 5 travasi | Cilindrata 49,3cc - Corsa mm 39,3 - Rapp. Comp. 1:13,5 | Completo di testa

RICAMBI

9913470	Pistone completo ø 40
9913471	Pistone completo ø 40,5
9913472	Pistone completo ø 41
9910380	Serie segmenti ø 40

9910381	Serie segmenti ø 40,5
9914270	Serie guarnizioni
9916570	Testa troncoconica



◀ cod. **9917400**

Gruppo termico Ø 40 adattabile a motori Derbi Senda – Bultaco Lobito

Cilindro in ghisa Minacrom | Cilindrata 49,94cc cm 3- Corsa mm. 40 | Completo di testa

RICAMBI

9918130	Pistone completo ø 40
9918131	Pistone completo ø 40,28
9918140	Serie segmenti ø 40
9918141	Serie segmenti ø 40,28

9922020	Serie guarnizioni
9918160	Testa

ATTENZIONE: QUESTI PRODOTTI SONO DESTINATI ESCLUSIVAMENTE AD USO AGONISTICO. NE È QUINDI VIETATO L'UTILIZZO SU STRADA PUBBLICA.



cod. **9924770**

Gruppo termico Ø 40 adattabile a motori Peugeot air cooled "EU2"

Cilindro in ghisa Minacrom con 7 travasi | Cilindrata 49,1cc - Corsa mm 39,1 - Rapp. Comp. 1:12 | Completo di testa

RICAMBI

9913370	Pistone completo ø 40
9913371	Pistone completo ø 40,5
9910380	Serie segmenti ø 40

9910381	Serie segmenti ø 40,5
9914720	Guarnizione base
9910760	Testa



cod. **9925640**

Gruppo termico Ø 40 per motori Peugeot H2O

Cilindro in ghisa Minacrom | Cilindrata 49,24cc - Corsa mm 39,2 - Rapp. Comp. 1:12,5 | Completo di testa

RICAMBI

9925870	Pistone completo ø 39,88
9925871	Pistone completo ø 40,28
9925880	Serie segmenti ø 39,88

9925881	Serie segmenti ø 40,28
9925890	Serie guarnizioni
9925900	Testa



cod. **9925650**

Gruppo termico Ø 40 per Keeway Focus

Cilindro in ghisa Minacrom con 6 travasi | Cilindrata 49,24cc - Corsa mm 39,2 - Rapp. Comp. 1:12,2 | Completo di testa

RICAMBI

9927210	Pistone completo ø 40
9927211	Pistone completo ø 40,5
9910380	Serie segmenti ø 40

9910381	Serie segmenti ø 40,5
9927220	Serie guarnizioni
9915880	Testa



cod. **9925830**

Gruppo termico Ø 40 per Peugeot Ludix 50cc

Cilindro in ghisa Minacrom con 6 travasi | Cilindrata 49,98cc - Corsa mm 39,8 - Rapp. Comp. 1:12,9 | Completo di testa

RICAMBI

9913370	Pistone completo ø 40
9913371	Pistone completo ø 40,5
9910380	Serie segmenti ø 40

9910381	Serie segmenti ø 40,5
9927880	Serie guarnizioni
9927470	Testa



◀ **cod. 9931110**

Gruppo termico Black Trophy Ø 40 Liquid Cooled per motori Minarelli/Yamaha
Cilindro in ghisa Minacrom con 7 travasi | Cilindrata 49,2cc – Corsa mm 39,2 – Rapp. Comp. 1:13 | Completo di testa

RICAMBI

9931130	Pistone completo MoS2 Ø 40
9910431	Pistone completo Ø 40,5
9910380	Serie segmenti Ø 40

9910381	Serie segmenti Ø 40,5
9915910	Serie guarnizioni
9915890	Testa



◀ **cod. 9931140**

Gruppo termico Black Trophy Ø 40 Air Cooled per motori Minarelli/Yamaha orizzontale
Cilindro in ghisa Minacrom con 7 travasi | Cilindrata 49,2cc - Corsa mm 39,2 - Rapp. Comp. 1:13 | Completo di testa

RICAMBI

9931130	Pistone completo MoS2 Ø 40
9910431	Pistone completo Ø 40,5
9910380	Serie segmenti Ø 40

9910381	Serie segmenti Ø 40,5
9915900	Serie guarnizioni
9915880	Testa



◀ **cod. 9931170**

Gruppo termico Black Trophy Ø 40 Air Cooled per motori Minarelli/Yamaha verticale
Cilindro in ghisa Minacrom con 7 travasi | Cilindrata 49,2cc - Corsa mm 39,2 - Rapp. Comp. 1:13 | Completo di testa

RICAMBI

9931130	Pistone completo MoS2 Ø 40
9910431	Pistone completo Ø 40,5
9910380	Serie segmenti Ø 40

9910381	Serie segmenti Ø 40,5
9916530	Serie guarnizioni
9916520	Testa



◀ **cod. 9916770**

Gruppo termico Ø 40,3 adattabile a motori Minarelli AM6 EU1 AM345/AM6
Cilindro in ghisa Minacrom 5 travasi | Cilindrata 49,7cc - Corsa mm. 39 - Rapp. Comp. 1:12 | Completo di testa

RICAMBI

9915610	Pistone completo ø 40,3
9915611	Pistone completo ø 40,6
9915612	Pistone completo ø 40,8
9915620	Serie segmenti ø 40,3

9915621	Serie segmenti ø 40,6
9915622	Serie segmenti ø 40,8
9915630	Serie guarnizioni
9916800	Testa

ATTENZIONE: QUESTI PRODOTTI SONO DESTINATI ESCLUSIVAMENTE AD USO AGONISTICO. NE È QUINDI VIETATO L'UTILIZZO SU STRADA PUBBLICA.



◀ **cod. 9926330**

Gruppo termico Ø 44 per Yamaha Giggle 50 cc 4T
Cilindro in alluminio | Cilindrata 64,28 cc - Corsa mm 43,6 - Rapp. Comp. 1:12

RICAMBI

992634A	Pistone completo ø 44
992634B	Pistone completo ø 44
992634C	Pistone completo ø 44
9926360	Serie segmenti ø 44

9926350	Serie guarnizioni
9926290	Spinotto + anellini
9928060	Centralina TFI programmata
9928070	Cablaggio TFI



◀ **cod. 9908660**

Gruppo termico Ø 47 per motori Peugeot Air Cooled
Cilindro in ghisa Minacrom con 5 travasi | Cilindrata 67,8cc - Corsa mm 39,1 - Rapp. Comp. 1:11,5 | Completo di testa
Pistone con riporto di stagno

RICAMBI

9915030	Pistone completo ø 47
9915031	Pistone completo ø 47,5
9910410	Serie segmenti ø 47

9910310	Serie guarnizioni
9910400	Testa



◀ **cod. 9917390**

Gruppo termico Ø 47 per motore Derbi Senda - Bultaco Lobito
Cilindro in ghisa Minacrom 6 travasi | Cilindrata 69,4cc - Corsa mm. 40 | Completo di testa

RICAMBI

9918220	Pistone completo ø 47
9918221	Pistone completo ø 47,4
9918230	Serie segmenti ø 47

9918231	Serie segmenti ø 47,4
9924710	Serie guarnizioni
9918250	Testa



◀ **cod. 9919540**

Gruppo termico Ø 47 per motori Peugeot Speedfight liquid cooled
Cilindro in ghisa Minacrom | Cilindrata 69,98cc - Corsa mm. 39,2 - Rapp. Comp. 1:13 | Completo di testa

RICAMBI

9915030	Pistone completo ø 47
9915031	Pistone completo ø 47,4
9910410	Serie segmenti ø 47

9910412	Serie segmenti ø 47,4
9920210	Serie guarnizioni
9919590	Testa



cod. **9924890**

Gruppo termico Ø 47 Keeway - CPI

Cilindro in ghisa Minacrom con 6 travasi | Cilindrata 67,97cc - Corsa mm 39,2 - Rapp. Comp. 1:12,5 | Completo di testa

RICAMBI

9925250	Pistone completo ø 47
9925251	Pistone completo ø 47,4
9906052	Serie segmenti ø 47

9906054	Serie segmenti ø 47,4
9925260	Serie guarnizioni
9906470	Testa



cod. **9925800**

Gruppo termico Ø 47 per Peugeot Ludix 50cc

Cilindro in ghisa Minacrom con 6 travasi | Cilindrata 69,01cc - Corsa mm 39,8 - Rapp. Comp. 1:12,7 | Completo di testa

RICAMBI

9915030	Pistone completo ø 47
9915031	Pistone completo ø 47,4
9910410	Serie segmenti ø 47

9910412	Serie segmenti ø 47,4
9927890	Serie guarnizioni
9910400	Testa



cod. **9931310**

Gruppo termico Black Trophy Ø 47 Liquid Cooled per motori Minarelli/Yamaha

Cilindro in ghisa Minacrom con 8 travasi | Cilindrata 68cc - Corsa mm 39,2 - Rapp. Comp.: 1:13 | Completo di testa

RICAMBI

9931330	Pistone completo MoS2 Ø 47
9906044	Pistone completo Ø 47,4
9906052	Serie segmenti Ø 47
9906054	Serie segmenti Ø 47,4

9910060	Serie guarnizioni
9909540	Testa
9910050	Accessori Testa



cod. **9931340**

Gruppo termico Black Trophy Ø 47 Air Cooled per motori Minarelli/Yamaha orizzontale

Cilindro in ghisa Minacrom con 5 travasi | Cilindrata 68cc - Corsa mm 39,2 - Rapp. Comp. 1:12,5 | Completo di testa

RICAMBI

9931330	Pistone completo MoS2 Ø 47
9906044	Pistone completo Ø 47,4
9906052	Serie segmenti Ø 47

9906054	Serie segmenti Ø 47,4
9907060	Serie guarnizioni
9906470	Testa

ATTENZIONE: QUESTI PRODOTTI SONO DESTINATI ESCLUSIVAMENTE AD USO AGONISTICO. NE È QUINDI VIETATO L'UTILIZZO SU STRADA PUBBLICA.



◀ cod. **9919250**

Gruppo termico Ø 49 per motori Minarelli AM6 EU1 AM345/6

Cilindro in ghisa Minacrom 5 travasi | Cilindrata 73,5cc - Corsa mm. 39 - Rapp. Comp. 1:12,5 | Completo di testa

RICAMBI

9906830	Pistone completo ø 49
9906831	Pistone completo ø 49,5
9906840	Serie segmenti ø 49
9906841	Serie segmenti ø 49,5

9907070	Serie guarnizioni
9906670	Testa
9906600	Spinotto

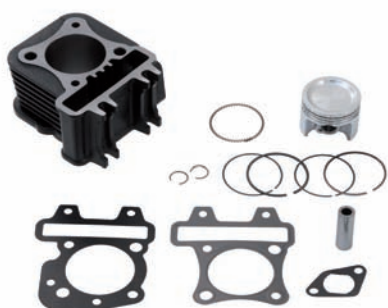

◀ cod. **9925150**

Gruppo termico Ø 49 per Piaggio 50cc 4T

Cilindro in ghisa Minacrom | Cilindrata 78,78cc - Corsa mm 41,8 - Rapp. Comp. 1:12

RICAMBI

9925490	Pistone completo ø 49
9925491	Pistone completo ø 49,5
9925550	Serie segmenti ø 49

9925551	Serie segmenti ø 49,5
9925570	Serie guarnizioni



◀ cod. **9928300**

Gruppo termico Ø 49 per Piaggio 4T 4V

Cilindro in ghisa Minacrom | Cilindrata 78,78cc - Corsa mm 41,8 - Rapp. Comp. 1:12

RICAMBI

9925490	Pistone completo ø 49
9925491	Pistone completo ø 49,5
9925550	Serie segmenti ø 49

9925551	Serie segmenti ø 49,5
9928280	Serie guarnizioni



◀ cod. **9925140**

Gruppo termico Ø 50 per Kymco 50cc 4T

Cilindro in ghisa Minacrom | Cilindrata 81,25cc - Corsa mm 41,4 - Rapp. Comp. 1:12

RICAMBI

9925500	Pistone completo ø 50
9925501	Pistone completo ø 50,5
9925560	Serie segmenti ø 50

9925561	Serie segmenti ø 50,5
9925580	Serie guarnizioni

ATTENZIONE: QUESTI PRODOTTI SONO DESTINATI ESCLUSIVAMENTE AD USO AGONISTICO. NE È QUINDI VIETATO L'UTILIZZO SU STRADA PUBBLICA.

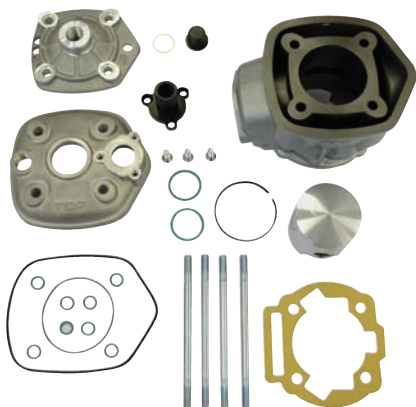

cod. 9927020

Gruppo termico Ø 50 per Derbi Senda (d50b0) motore Piaggio

Cilindro in ghisa Minacrom con 7 travasi | Cilindrata 78cc - Corsa mm 40 - Rapp. Comp. 1:14 | Completo di testa

RICAMBI

9927010	Pistone completo ø 50
9927011	Pistone completo ø 50,4
9924150	Segmento ø 50
9924151	Segmento ø 50,4
9930240	Serie guarnizioni

9930280	Testa
9928090	Raccordo testa
9929480	Serie prigionieri M7 x 115
9930270	Tappo cilindrico
9924250	Spinotto + anellini



cod. 9911090

Kit di trasformazione raffreddamento da aria ad acqua per motori Minarelli/Yamaha tipo orizzontale

Parte termica standard e pompa per il raffreddamento forzato, completa di dispositivi per la sua applicazione

RICAMBI

9931330	Pistone completo ø 47
9931331	Pistone completo ø 47,4
9906052	Serie segmenti ø 47
9906054	Serie segmenti ø 47,4
9910060	Serie guarnizioni

9905910	Spinotto
9909540	Testa
9911080	Coperchio volano completo
9931310	Gruppo termico ø 47 Black Trophy
9910050	Accessori per testa

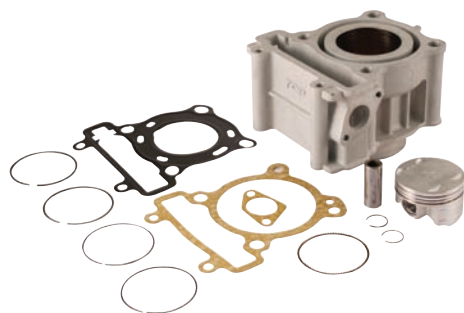

cod. 9932700

Gruppo termico Ø 52 per motori Minarelli/Yamaha X-Max 125cc 4T 4v

Cilindro in alluminio | Cilindrata 124,6 cc - Corsa 58,6 - Rapp. Comp. 11,2:1

RICAMBI

9932750	Pistone completo ø 52
9932760	Serie segmenti ø 52

9932770	Serie guarnizioni
---------	-------------------



cod. 9929650

Gruppo termico Ø 52,4 per Honda SH 125cc

Cilindro in alluminio | Cilindrata 124,6 cc - Corsa mm 57,8 - Rapp. Comp. 1:11,5

RICAMBI

9929680	Pistone completo ø 52,4
9929720	Serie segmenti ø 52,4

9929750	Serie guarnizioni
---------	-------------------



◀ **cod. 9929450**

Gruppo termico Ø 58 per Honda SH 125cc

Cilindro in alluminio | Cilindrata 152,7cc - Corsa mm 57,8 - Rapp. Comp. 1:13,5

RICAMBI

9929520	Pistone completo ø 58
9929560	Serie segmenti ø 58

9929630	Serie guarnizioni
---------	-------------------



◀ **cod. 9929950**

Gruppo termico Ø 58 per Honda SH 150cc

Cilindro in alluminio | Cilindrata 152,7cc - Corsa mm 57,8 - Rapp. Comp. 1:13,5

RICAMBI

9929520	Pistone completo ø 58
9929560	Serie segmenti ø 58

9929630	Serie guarnizioni
---------	-------------------



◀ **cod. 9929380**

Gruppo termico Ø 62,2 per Yamaha Majesty 125/150cc

Cilindro in ghisa | Cilindrata 166cc - Corsa mm 58,4 - Rapp. Comp. 1:11,7

RICAMBI

9929390	Pistone completo ø 62,2
9929391	Pistone completo ø 62,7
9929410	Serie segmenti ø 62,2

9929411	Serie segmenti ø 62,7
9929400	Serie guarnizioni



◀ **cod. 9925180**

Kit gruppo termico Ø 63 con centralina per Yamaha X-MAX 125cc 4T

Cilindro in alluminio | Cilindrata 182,67cc - Corsa mm 58,6 - Rapp. Comp. 1:11,5 | Completo di testa

RICAMBI

992539A	Pistone completo ø 63
992539B	Pistone completo ø 63
992539C	Pistone completo ø 63
9925400	Serie segmenti ø 63
9925590	Serie guarnizioni

9926720	Cablaggio per centralina TFI
9926710	Centralina TFI completa
9926730	Emulatore sonda Lambda
9926870	Gruppo termico ø 63

ATTENZIONE: QUESTI PRODOTTI SONO DESTINATI ESCLUSIVAMENTE AD USO AGONISTICO. NE È QUINDI VIETATO L'UTILIZZO SU STRADA PUBBLICA.



◀ **cod. 9926900**

Kit gruppo termico Ø 63 con centralina per Yamaha YZF R 125cc 4t
Cilindro in alluminio | Cilindrata 182,67cc - Corsa mm. 58,6 - Rapp. Comp. 1:11,5

RICAMBI

992539A	Pistone completo ø 63
992539B	Pistone completo ø 63
992539C	Pistone completo ø 63
9925400	Serie segmenti ø 63

9925590	Serie guarnizioni
9926870	Gruppo termico ø 63
9926720	Cablaggio per centralina TFI
9926890	Centralina TFI completa



◀ **cod. 9927120**

Gruppo termico Ø 63 per Fantic Caballero 125cc 4t
Cilindro in alluminio | Cilindrata 182,67cc - Corsa mm. 58,6 - Rapp. Comp. 1:11,5

RICAMBI

992539A	Pistone completo ø 63
992539B	Pistone completo ø 63
992539C	Pistone completo ø 63

9925400	Serie segmenti ø 63
9925590	Serie guarnizioni
9927670	Serie getti



◀ **cod. 9927260**

Kit gruppo termico Ø 63 con centralina per Yamaha WR R 125cc 4t
Cilindro in alluminio | Cilindrata 182,67cc - Corsa mm. 58,6 - Rapp. Comp. 1:11,5

RICAMBI

992539A	Pistone completo ø 63
992539B	Pistone completo ø 63
992539C	Pistone completo ø 63
9925400	Serie segmenti ø 63

9925590	Serie guarnizioni
9926870	Gruppo termico ø 63
9926720	Cablaggio per centralina TFI
9927250	Centralina TFI completa

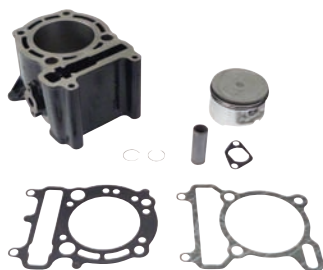

◀ **cod. 9926850**

Gruppo termico ø 69 per Yamaha Majesty 250 cc
Cilindro in ghisa | Cilindrata 249,66cc - Corsa mm. 66,8 - Rapp. Comp. 1:10,1

RICAMBI

9930470	Pistone completo ø 69
9930380	Serie segmenti ø 69

9930430	Serie guarnizioni
---------	-------------------



cod. **9911210**

RACING

Kit Racing di trasformazione raffreddamento da aria ad acqua per motori Minarelli/Yamaha 50cc orizzontale
Parte termica racing e pompa per il raffreddamento forzato, con tutti i dispositivi per la sua applicazione

RICAMBI

9910550	Pistone completo ø 47
9908801	Pistone completo ø 47,4
9908770	Segmento ø 47
9908771	Segmento ø 47,4
9910060	Serie guarnizioni

9910120	Testa
9910050	Accessori per testa
9905910	Spinotto
9912800	Gruppo termico ø 47 "Due plus"
9911080	Coperchio volano completo



cod. **9912800**

RACING

Gruppo termico Ø 47 Racing "Due Plus" per motori Minarelli/Yamaha 50cc Liquid Cooled
Cilindro in ghisa Minacrom con 8 travasi | Cilindrata 67,9cc - Corsa mm. 39,2 - Rapp. Comp. 1:14 | Completo di testa

RICAMBI

9910550	Pistone completo ø 47
9908801	Pistone completo ø 47,4
9908770	Segmento ø 47
9908771	Segmento ø 47,4

9910060	Serie guarnizioni
9910120	Testa
9910050	Accessori per testa
9905910	Spinotto



cod. **9921160**

RACING

Gruppo termico Ø 47 Racing "Due Plus" con testa scomposta per motori Minarelli/Yamaha 50cc Liquid Cooled
Cilindro in ghisa Minacrom con 8 travasi | Cilindrata 68,3cc - Corsa mm. 39,2 - Rapp. Comp. 1:14 | Completo di testa

RICAMBI

9910550	Pistone completo ø 47
9908801	Pistone completo ø 47,4
9908770	Segmento ø 47
9908771	Segmento ø 47,4
9921310	Serie guarnizioni

9920500	Testa scomponibile
9910050	Accessori per testa
9905910	Spinotto
9914540	Gabbia a rulli



cod. **9930000**

RACING

Gruppo termico Ø 47 Racing "Gold line" per motori Minarelli/Yamaha tipo verticale
Cilindro in ghisa Minacrom 7 travasi | Cilindrata 67,9cc - Corsa mm. 39,2 - Rapp. Comp. 1:13,7 | Completo di testa

RICAMBI

9908800	Pistone completo ø 47
9908801	Pistone completo ø 47,4
9908770	Segmento ø 47
9908771	Segmento ø 47,4

9906760	Serie guarnizioni
9930020	Testa Black
9905910	Spinotto

ATTENZIONE: QUESTI PRODOTTI SONO DESTINATI ESCLUSIVAMENTE AD USO AGONISTICO. NE È QUINDI VIETATO L'UTILIZZO SU STRADA PUBBLICA.

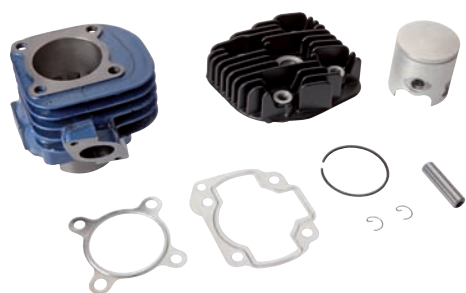

cod. **9930030** **RACING**

Gruppo termico "Gold Line" Ø 47 Racing per motori Minarelli/Yamaha tipo orizzontale air cooled
Cilindro in ghisa Minacrom 8 travasi | Cilindrata 67,9cc - Corsa mm. 39,2 - Rapp. Comp. 1:13,6 | Completo di testa

RICAMBI

9908800	Pistone completo ø 47
9908801	Pistone completo ø 47,4
9908770	Segmento ø 47
9908771	Segmento ø 47,4

9907060	Serie guarnizioni
9930050	Testa Black
9905910	Spinotto

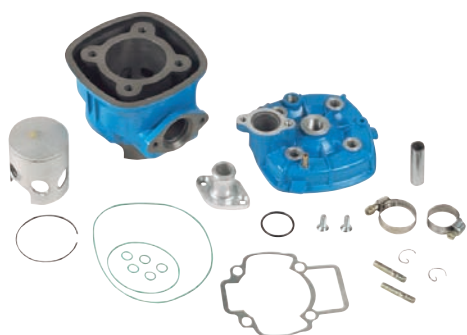

cod. **9920590** **RACING**

Gruppo termico Ø 47,6 racing "Due Plus" per motori Gilera/Piaggio 50cc liquid cooled
Cilindro in ghisa Minacrom con 6 travasi | Cilindrata 69,9cc - Corsa mm. 39,3 - Rapp. Comp. 1:14 | Completo di testa

RICAMBI

9920650	Pistone completo ø 47,6
9920651	Pistone completo ø 48
9913700	Segmento ø 47,6
9913701	Segmento ø 48

9920660	Serie guarnizioni
9920620	Testa
9915950	Raccordo per testa



cod. **9921550** **RACING**

Gruppo termico Ø 47,6 "TPR" in alluminio per motori Gilera/Piaggio 50cc air cooled
Cilindro in alluminio | Cilindrata 69,9cc - Corsa mm. 39,3 - Rapp. Comp. 1:14,7 | Completo di testa

RICAMBI

992153A	Pistone completo ø 47,6
992153B	Pistone completo ø 47,6
992153C	Pistone completo ø 47,6
9921540	Segmento ø 47,6

9921650	Serie guarnizioni
9913680	Testa
9907820	Gabbia a rulli
9921520	Spinotto ø 12



cod. **9921630** **RACING**

Gruppo termico Ø 47,6 "TPR" in alluminio per motori scooter 50cc Minarelli/Yamaha tipo orizzontale air cooled
Cilindro in alluminio | Cilindrata 69,9cc - Corsa mm. 39,2 - Rapp. Comp. 1:14,5 | Completo di testa

RICAMBI

992161A	Pistone completo ø 47,6
992161B	Pistone completo ø 47,6
992161C	Pistone completo ø 47,6
9921540	Segmento ø 47,6

9907060	Serie guarnizioni
9910540	Testa
9914540	Gabbia a rulli
9921600	Spinotto ø 10



cod. 9921640 **RACING**

Gruppo termico Ø 47,6 "TPR" in alluminio per motori scooter 50cc Minarelli/Yamaha tipo verticale air cooled

Cilindro in alluminio | Cilindrata 69,9cc - Corsa mm. 39,2 - Rapp. Comp. 1:14,5 | Completo di testa

RICAMBI

992161A	Pistone completo ø 47,6
992161B	Pistone completo ø 47,6
992161C	Pistone completo ø 47,6
9921540	Segmento ø 47,6

9906760	Serie guarnizioni
9908790	Testa
9914540	Gabbia a rulli
9921600	Spinotto ø 10



cod. 9930060 **RACING**

Gruppo termico Ø 47,6 Racing "Gold line" per motori Gilera/Piaggio 50cc air cooled

Cilindro in ghisa Minacrom 6 travasi di cui 4 contrapposti (2 posizionati posteriormente per ottimizzare il riempimento) | Cilindrata 69,9cc - Corsa mm. 39,3 - Rapp. Comp. 1:13,5 | Completo di testa

RICAMBI

9913690	Pistone completo ø 47,6
9913691	Pistone completo ø 48
9913700	Segmento ø 47,6

9913701	Segmento ø 48
9914290	Serie guarnizioni
9930080	Testa Black



cod. 9919240 **RACING**

Gruppo termico Ø 49,5 Racing per motori Minarelli 50cc AM6 EU1 AM345/6

Cilindro in ghisa Minacrom 5 travasi | Cilindrata 75cc - Corsa mm. 39 - Rapp. Comp. 1:13 | Completo di testa

RICAMBI

9915780	Pistone completo ø 49,5
9915781	Pistone completo ø 49,7
9915710	Segmento ø 49,5
9915711	Segmento ø 49,7

9907070	Serie guarnizioni
9915870	Testa
9906600	Spinotto



cod. 9921150 **RACING**

Gruppo termico Ø 49,5 Racing "Due plus" con testa scomposta per motori Minarelli 50cc AM

Cilindro in ghisa Minacrom 5 travasi | Cilindrata 75cc - Corsa mm 39 - Rapp. Comp. 1:14,5 | Completo di testa

RICAMBI

9915780	Pistone completo ø 49,5
9915781	Pistone completo ø 49,7
9915710	Segmento ø 49,5
9915711	Segmento ø 49,7

9921320	Serie guarnizioni
9920530	Testa scomponibile
9921330	Gabbia a rulli
9906600	Spinotto

ATTENZIONE: QUESTI PRODOTTI SONO DESTINATI ESCLUSIVAMENTE AD USO AGONISTICO. NE È QUINDI VIETATO L'UTILIZZO SU STRADA PUBBLICA.



cod. 9921450

RACING

Gruppo termico Ø 49,5 **Maxi Kit Racing** per motori Minarelli AM 50cc
Cilindro in ghisa Minacrom | Cilindrata 85cc - Corsa mm. 44 - Rapp. Comp. 1:14,7 | Completo di testa

RICAMBI

9921760	Gruppo termico ø 49,5
9915780	Pistone completo ø 49,5
9915781	Pistone completo ø 49,7
9915710	Segmento ø 49,5
9915711	Segmento ø 49,7
9921320	Serie guarnizioni

9921460	Testa scomponibile
9906600	Spinotto
9920410	Albero motore
9921330	Gabbia a rulli
9921770	Chiavetta
9924750	Kit cuscinetti paraoli banco

NB: il codice 9921760 deve essere tassativamente montato con il codice 9920410.



cod. 9924130

RACING

Gruppo termico Ø 50 "TPR" in alluminio per motori Minarelli AM 50cc
Cilindro in alluminio | Cilindrata 76,5cc - Corsa mm 39 - Rapp. Comp. 1:14 | Completo di testa

RICAMBI

992414A	Pistone completo ø 50
992414B	Pistone completo ø 50
992414C	Pistone completo ø 50
9924150	Segmento ø 50
9924160	Serie guarnizioni

9920530	Testa scomponibile
9921330	Gabbia a rulli
9924250	Spinotto e anellini
9924110	Boccola riduzione scarico ø 28/32mm
9924120	Boccola scarico ø 32 mm



cod. 9924240

RACING

Gruppo termico Ø 50 **Maxi Kit "TPR"** per motori Minarelli AM 50cc
Cilindro in alluminio | Cilindrata 86cc - Corsa mm 44 - Rapp. Comp. 1:14,2 | Completo di testa

RICAMBI

9924230	Gruppo termico ø 50
992414A	Pistone completo ø 50
992414B	Pistone completo ø 50
992414C	Pistone completo ø 50
9924150	Segmento ø 50
9924160	Serie guarnizioni
9921460	Testa scomponibile

9924110	Boccola ø 28/32 mm
9924120	Boccola ø 32 mm scarico
9924250	Spinotto e anellini
9920410	Albero motore
9921770	Chiavetta scarico
9921330	Gabbia a rulli
9924750	Kit cuscinetti paraoli banco

NB: il codice 9924230 deve essere tassativamente montato con il codice 9920410.



cod. 9926560

RACING

Gruppo termico Ø 50 **Maxi Kit "TPR"** per motori scooter 50cc Minarelli/Yamaha liquid cooled corsa 44
Cilindro in alluminio | Cilindrata 86cc - Corsa mm. 44 - Rapp. Comp. 1:15 | Completo di testa

RICAMBI

9929310	Gruppo termico ø 50
992414A	Pistone completo ø 50
992414B	Pistone completo ø 50
992414C	Pistone completo ø 50
9924150	Segmento ø 50
9929330	Serie guarnizioni
9929320	Testa

9924250	Spinotto e anellini
9929480	Serie prigionieri
KK01002	Kit cuscinetti paraoli banco
9925980	Albero motore
9925930	Biella
9921330	Gabbia a rulli



◀ cod. **9926580** **RACING**

Gruppo termico Ø 50 **Maxi Kit "TPR"** per motori scooter 50cc Minarelli/Yamaha liquid cooled corsa 39,2
Cilindro in alluminio | Cilindrata 77cc - Corsa mm. 39,2 - Rapp. Comp. 1:14,5 | Completo di testa

RICAMBI

9929340	Gruppo termico ø 50
992414A	Pistone completo ø 50
992414B	Pistone completo ø 50
992414C	Pistone completo ø 50
9924150	Segmento ø 50
9929330	Serie guarnizioni

9929350	Testa
9924250	Spinotto e anellini
KK01002	Kit cuscinetti e paraoli banco
9926170	Albero motore
9925930	Biella
9921330	Gabbia a rulli



◀ cod. **9928390** **RACING**

Gruppo termico Ø 50 **Maxi Kit "TPR"** per motori scooter 50cc Piaggio/Gilera/Derbi liquid cooled corsa 39,3
Cilindro in alluminio | Cilindrata 77cc - Corsa mm. 39,3 - Rapp. Comp. 1:14,5 | Completo di testa

RICAMBI

9929800	Gruppo termico ø 50
992414A	Pistone completo ø 50
992414B	Pistone completo ø 50
992414C	Pistone completo ø 50
9924150	Segmento ø 50
9929820	Serie guarnizioni

9929810	Testa
9924250	Spinotto e anellini
KK01009	Kit cuscinetti e paraoli banco
9926220	Albero motore
9929470	Biella
9921330	Gabbia a rulli



◀ cod. **9928440** **RACING**

Gruppo termico Ø 50 **Maxi Kit "TPR"** per motori scooter 50cc Piaggio/Gilera/Derbi liquid cooled corsa 44
Cilindro in alluminio | Cilindrata 86cc - Corsa mm. 44 - Rapp. Comp. 1:15 | Completo di testa

RICAMBI

9929840	Gruppo termico ø 50
992414A	Pistone completo ø 50
992414B	Pistone completo ø 50
992414C	Pistone completo ø 50
9924150	Segmento ø 50
9929820	Serie guarnizioni

9929850	Testa
9924250	Spinotto e anellini
KK01009	Kit cuscinetti e paraoli banco
9926210	Albero motore
9929470	Biella
9921330	Gabbia a rulli

ATTENZIONE: QUESTI PRODOTTI SONO DESTINATI ESCLUSIVAMENTE AD USO AGONISTICO. NE È QUINDI VIETATO L'UTILIZZO SU STRADA PUBBLICA.

NEW



◀ cod. **9928480**
Gruppo Termico Ø 47,6 Spinotto 10 "TPR 2" motori scooter 50cc
Minarelli/Yamaha Liquid Cooled

RICAMBI

9914540	Gabbia a rulli
9920500	Testa Scomponibile
9921540	Segmento Ø 47,6
992847A	Pistone Completo Ø 47,6

992847B	Pistone Completo Ø 47,6
992847C	Pistone Completo Ø 47,6
9931280	Serie Guarnizioni

NEW



◀ cod. **9928520**
Gruppo Termico Ø 47,6 "TPR 2" motori scooter 50cc Piaggio Liquid Cooled

RICAMBI

9907820	Gabbia a rulli
9921360	Testa Scomponibile
9921540	Segmento Ø 47,6
992851A	Pistone Completo Ø 47,6

992851B	Pistone Completo Ø 47,6
992851C	Pistone Completo Ø 47,6
9931390	Serie Guarnizioni

NEW



◀ cod. **9928550**
Gruppo Termico Ø 47,6 Spinotto 12 "TPR 2" motori scooter 50cc
Minarelli/Yamaha Liquid Cooled

RICAMBI

9920500	Testa Scomponibile
9921330	Gabbia A Rulli
9921540	Segmento Ø 47,6
992851A	Pistone Completo Ø 47,6

992851B	Pistone Completo Ø 47,6
992851C	Pistone Completo Ø 47,6
9931280	Serie Guarnizioni



◀ **cod. 9921090** **RACING**

Scarico Racing per motori Minarelli AM

APPLICABILITÀ

Malaguti XSM 50 50 2T -00, XTM 50 50 2T -00
Mbk X Limit 50 2T -00

Yamaha DT R 50 2T 03-10, DT RSM 50 2T 03-05, DT X 50 2T 06-10

RICAMBI

9921100	Silenziatore di ricambio
----------------	--------------------------

◀ **cod. 9924340** **RACING**

Scarico Racing omologato per HM

APPLICABILITÀ

HM Baja, Derapage Basic 50 2T 10-11, CMC 50 2T 10-11, CRE Baja RR, Derapage RR 50 2T 07-11, CRE Baja, Derapage 50 2T 07-11, CRE Six Competition 50 2T 10-11, CRE Six, Baia, Derapage 50 2T 95-06, CRE Six, Derapage Competition 50 2T 07-09, Derapage Competition 50 2T 10-11

RICAMBI

9924350	Silenziatore di ricambio
----------------	--------------------------



◀ **cod. 9926370** **RACING**

Scarico Racing omologato per Aprilia RS 50 fino '05

APPLICABILITÀ

Aprilia RS 50 50 2T 99-05, Tuono 50 50 2T 03-04

RICAMBI

9920240	Silenziatore di ricambio
----------------	--------------------------

◀ **cod. 9926880** **RACING**

Scarico Racing omologato per Yamaha TZR 50

APPLICABILITÀ

MBK X Power 50 2T -00

Yamaha TZR 50 2T 03-08, TZR 50 2T 10-11, TZR RR 50 2T 05-05

RICAMBI

9920240	Silenziatore di ricambio
----------------	--------------------------



◀ **cod. 9927350** **RACING**

Scarico completo Yamaha YZF 125 R

APPLICABILITÀ

Yamaha YZF-R IE 125 4T 4V IE 08-13

ATTENZIONE: QUESTI PRODOTTI SONO DESTINATI ESCLUSIVAMENTE AD USO AGONISTICO. NE È QUINDI VIETATO L'UTILIZZO SU STRADA PUBBLICA.



cod. **9931440** **RACING**
 Scarico **Nardò 2** omologato per motore orizzontale

APPLICABILITÀ

Attenzione: lo scarico è omologato esclusivamente per i modelli evidenziati in grassetto

Aprilia	Area 51 50 2T 98-00, Gulliver 50 2T 95-98, Gulliver LC 50 2T 96-98, Rally 50 2T 95-03, Rally Liquid Cooled 50 2T 96-99, SR (Orizzontale) 50 2T 94-96, SR Liquid Cooled 50 2T 94-96, SR Racing 50 2T 97-99, SR Stealth 50 2T 97-99, SR WWW 50 2T 97-01 , Scarabeo 50 2T 93-98, Sonic 50 2T 98-07, Sonic GP 50 2T 98-08	Italjet	Dragster 50 2T -00	Mbk	Evolis 50 2T 92-95, Fizz 50 2T 94-95, Flipper 50 2T -00, Flipper Euro 2 50 2T 03-03, Forte 50 2T 94-96, Mach G 50 2T 02-04, Mach G LC 50 2T 02-04, Nitro 50 2T -00, Nitro Euro 2 50 2T 03-03 , Ovetto 50 2T -00, Ovetto Euro 2 50 2T 02-02
Benelli	491 GT 50 2T 98-99, 491 Racing 50 2T 98-99, K2 50 2T 98-01, K2 Liquid Cooled 50 2T 98-01, Pepe 50 2T 99-01	Malaguti	Centro 50 2T -00, Ciak 50 2T -00, Ciak Euro 2 2,3 50 2T 03-03, Ciak Euro2 50 2T 01-03, Ciak Master Euro 2 50 2T 06-06, F10 50 2T -00, F10 Euro 2 50 2T -00, F10 Euro 2,2,3 50 2T 03-04 , F10 Restyling Euro 2 50 2T 06-06, F12 Phantom 50 2T -00, F12 Phantom Euro 2 2,3 50 2T 03-04, F12 Phantom LC 50 2T -00 , F12 R Phantom LC 50 2T 07-07, F12 Restyling Euro 2 50 2T 06-06, F15 Firefox 50 2T -00, F15 Firefox Euro 2 50 2T 02-06, F15 Firefox Euro 2,2,3 50 2T 03-04, Yesterday 50 2T 97-00	Yamaha	Aerox 50 2T -00, Aerox Euro 2 50 2T 03-03 , Axis 50 2T 95-96, Breeze 50 2T 94-95, Jog 50 2T -00, Jog ER 50 2T -00, Jog R 50 2T 02-10, Jog R LC 50 2T -00, Jog Z 50 2T 95-95, Neo's 50 2T -00, Neo's Euro 2 50 2T 02-02, Why 50 2T -00, Why Euro 2 50 2T 03-03, Zest 50 2T -00
Beta	Ark 50 2T 96-08, Ark LC 50 2T 96-08, Chrono 50 2T 96-00, Eikon 50 2T 99-03, Quadra 50 2T 95-00, Tempo 50 2T 95-00				

RICAMBI

9931530	Silenziatore	9931470	Kit staffa
---------	--------------	---------	------------

cod. **9931450** **RACING**
 Scarico **Nardò 2** omologato per motore verticale

Attenzione: lo scarico è omologato esclusivamente per i modelli evidenziati in grassetto

APPLICABILITÀ

Aprilia	Amico 50 2T 94-94, Amico 50 2T 96-98, Amico GL/GLE 50 2T 93-95, Amico LX/Sport/Cat 50 2T 92-93, SR (Verticale) 50 2T 93-93	Mbk	Booster 50 2T -00, Booster NG 50 2T -00, Booster Rocket 50 2T 97-98, Booster Spirit 50 2T -00, Booster Track 50 2T 96-98, Stunt 50 2T 00-02	Yamaha	BWS 50 2T -00, BWS Bump 50 2T 97-98, BWS NG 50 2T -00 , Slider 50 2T 00-02, Spy 50 2T 95-98, Zuma 50 2T 97-01
Italjet	Bazooka 50 2T -00, Pista 50 2T -00, Pista 2 50 2T -00, Scoop 50 2T -00, Scoop 2 50 2T -00, Yankee 50 2T -00				

RICAMBI

9931530	Silenziatore	9931490	Kit staffa
---------	--------------	---------	------------

cod. **9931460** **RACING**
 Scarico **Nardò 2** omologato per motore Piaggio 50cc

Attenzione: lo scarico è omologato esclusivamente per i modelli evidenziati in grassetto

APPLICABILITÀ

Aprilia	SR R 50 2T 04-09, SR R FACTORY 50 2T 04-09, SR R FACTORY Carburatore 50 2T 10-12, Scarabeo 2T EU2 Motore Piaggio 50 2T 10-12, Scarabeo 2T Net 50 2T 09-10, Scarabeo Street 50 2T 05-06, Scarabeo Street 2T Restyling 50 2T 06-09	Gilera	DNA 50 2T 00-02, DNA 50 2T 05-07, DNA GP Experience 50 2T 03-04, Easy Moving 50 2T 95-96, Ice 50 2T 01-05, Runner 50 2T 97-00 , Runner Poggiali 50 2T 02-02, Runner Pure Jet 50 2T-IE 02-07, Runner Pure Jet 50 2T-IE 10-11, Runner Pure Jet ST 50 2T-IE 08-08, Runner SP 50 2T 02-07, Runner SP 50 2T 10-12, Runner SP ST & Simoncelli 50 2T 08-09, Runner SP Special Edition 50 2T 07-07, Stalker 50 2T 97-11, Stalker Naked 50 2T 08-08, Stalker Special Edition 50 2T 07-08, Storm 50 2T 94-95, Storm Euro 2 50 2T 07-07, Typhoon 50 2T 94-97, Typhoon X 50 2T 98-99 , Typhoon XR 50 2T 00-00	Piaggio	Diesis 50 2T 01-01, Fly 2T 50 2T 05-07, Fly 2T 50 2T 10-11, Free 50 2T 92-94, Free Delivery 50 2T 00-01, Free FL 50 2T 95-02, Liberty 50 2T 97-05, Liberty 2T 50 2T 06-08, Liberty 2T PTT EU2 50 2T 04-05, Liberty 2T RST 50 2T 04-04, Liberty 2T Sport 50 2T 06-08, Liberty MOC 2T & Elle 50 2T 09-12, NRG 50 2T 94-96, NRG Extreme 50 2T 99-00, NRG MC3 50 2T 01-04, NRG Power DD 50 2T 05-11, NRG Power DD Serie Speciale 50 2T 07-11, NRG Power DT 50 2T 06-11, NRG Power DT Serie Speciale 50 2T 07-08, NRG Power Pure Jet 50 2T-IE 04-05, NRG Power PureJet 50 2T-IE 06-11, NRG PureJet 50 2T-IE 02-04, NRG PureJet 50 2T-IE 10-10, NRG RST MC2 50 2T 96-98, NTT 50 2T 95-96, Quartz 50 2T 92-96, Sfera 50 2T 91-93, Sfera Maquillage 2 50 2T 94-94, Sfera RST 50 2T 95-97, Typhoon 50 2T 01-09, Typhoon 2T E2 50 2T 10-12, Typhoon 2T E3 CH 50 2T 11-11, Vespa ET2 50 2T 97-05, Vespa ET2 iniezione 50 2T 97-00, Vespa LX 2T 50 2T 05-08, Vespa LX 2T FL 50 2T 09-10, Vespa LX 2T Touring 50 2T 10-11, Vespa LXV 2T 50 2T 06-08, Vespa LXV 2T NAVY 50 2T 08-08, Vespa S 2T & College 50 2T 07-12, Zip 50 2T 92-93, Zip 50 2T 95-96 , Zip 2T 50 2T 08-12, Zip Bimodale 50 2T 94-97 , Zip Fast Rider 50 2T 93-94, Zip Fast Rider RST 50 2T 96-97 , Zip LC 50 2T 00-04, Zip RST 50 2T 96-99 , Zip Sp 50 2T 96-04, Zip Sp Euro 2 50 2T 06-12
Derbi	Atlantis 2T 50 2T 10-10, Atlantis 2T EU2 50 2T 07-09, Atlantis O2 50 2T 02-02, Atlantis O2 Bullet 50 2T 03-05, Atlantis O2 City 50 2T 03-06, Atlantis O2 Red Bullet 50 2T 03-03, Atlantis O2 Two Chic 50 2T 05-05, Boulevard 50 2T 09-12, GP1 50 2T 01-03, GP1 EU2 50 2T 05-05, GP1 Open EU2 50 2T 06-09, GP1 Race EU2 50 2T 05-07, Sonar 2T 50 2T 09-09	Italjet	Jet Set 50 2T -00, Torpedo New 50 2T -00		

RICAMBI

9931530	Silenziatore	9931510	Kit staffa
---------	--------------	---------	------------

ATTENZIONE: QUESTI PRODOTTI SONO DESTINATI ESCLUSIVAMENTE AD USO AGONISTICO. NE È QUINDI VIETATO L'UTILIZZO SU STRADA PUBBLICA.



◀ cod. **9932900**
Scarico "Powered 2" Kymco Agility 2T

APPLICABILITÀ

Kymco Yup 50	S60010- S6
Kymco Bet&Win 50	S80010 - S8
Kymco Dink 50	S80010- S8
Kymco People 50 Eco Kat	BA10AD - B1 - (RFB)B10000 - (RFB)B10010-B1 Vers.02
Kymco Super 8 50 2L	KFJOAA

Kymco Super 9 50 2T	SH10DM - SI
Kymco Top Boy On/Off 50	SF10AG - SF10GG - SF
Kymco Vitality 50	SF10FA - U31000- U3
Sym Eurojet 50	RFGBL05- BL05- BL05W6-6
Kymco Agility 50 R16	CK50QT-6A



◀ cod. **9932910**
Scarico "Powered 2" Piaggio Vespa ET2

APPLICABILITÀ

Piaggio Vespa 50 Et2	C16100-ZAPCJ6000 - ZAPC12000
----------------------	------------------------------



◀ cod. **9932920**
Scarico "Powered 2" Gilera Typhoon

APPLICABILITÀ

Piaggio Ntt	SAL1T- SAL1T300
Piaggio Nrg Mc2 (1999) Liquid	C21100 - C210 - C21000 - C220 - C22000 - C22100 - C041 - C18
Piaggio Nrg Mc2 (1999) Air	C21100-C210-C21000 - C220 - C22000 - C041 - C18
Piaggio Nrg Mc2 ('98)	C04000 - ZAPCO4000 - DDZAPC1800 - ZAPC2100- DDZAPC2200
Piaggio Nrg Mc2 ('97)	C04100 - ZAPCO4000 - DDZAPC1800 - ZAPC2100 - DDZAPC2200

Piaggio Nrg Mc2 Extreme	C2200 - ZAPC220 - 21
Piaggio Nrg	SAL1T (NRG) - SAL1T022
Gilera Typhoon	TEC1T - TEC2T
Gilera Typhoon 50	C48 var. 1 ver.00
Gilera Storm	TEC1T
Piaggio Zip Sp	CI 1100 - ZAPC11000



◀ cod. **9932930**
Scarico "Powered 2" Peugeot Speedfight

APPLICABILITÀ

Peugeot Squab 50	S1A - VGAS1A01
Peugeot Speedfight (Liquid)	S1B00-B - VGAS1B00B - VGA- S1B00A - S1B - S1BDE - S1BKB - S1BOKB
Peugeot Speedfight (Air)	S1B - VGAS1 - BOKKA - S1BDE- S1BOKA- S1BOKA - S1BOKF

Peugeot Metal-X 50	S1AOKF
Peugeot X-Fight 50 Kat	S1 Var.3B Vers.A4



◀ cod. **9932940**
Scarico "Powered 2" Yamaha Neo's

APPLICABILITÀ

Mbk Ovetto	SAD (MBK YN50) - SAD - VTLSAD
------------	-------------------------------

Yamaha Neo's 50	SAD (Yamaha YN50) - VTL5AD - VTLSA34 - SA3
-----------------	--



◀ cod. **9932950**
Scarico "Powered 2" MBK Booster FINO AL 2004

APPLICABILITÀ

Yamaha Slider 50 Kat	SA09 - SA - SA091
Yamaha Bw's Next Generation	4TD - 4SB/4VA - VG5SA-5LF1 - NP4YB200 - 4VA
Yamaha Bw's Next Generation Kat	5FL - 5NU
Yamaha Bw's 50	3WW (CW50) - 4BX - 4VU2 - VG5SA061001 - 5LE1 - VGASA056 - VGASA057
Mbk Stunt	5LH

Mbk Rocket	4SB-4VA
Mbk Booster 50 Next Generation	4TD- 4SB - 4VA - VG5SA052001- 5LF1
Mbk Booster Next Generation 50 Kat	5FL- 5NU
Mbk Booster 50	3WW (CW50) - 4BX - 4PA1 - 4WW - VG5SA062001 - 5LE2
Yamaha Spy	4UP



◀ cod. **9932960**
Scarico "Powered 2" Malaguti F15

APPLICABILITÀ

Malaguti F15 Firefox	440101- 2JM44 - 44000
Mbk Nitro 50	5BR - 5BR0000

Yamaha Aerox 50	5BR - 5BR0000
-----------------	---------------



◀ cod. **9932980**
Scarico "Powered 2" Piaggio Zip

APPLICABILITÀ

Piaggio Zip Kat (Air Cooled)	C06111 - C025 - ZAPC025 - C25
Piaggio Fly 50	C44 VAR.1 VERS.00 - ZAP C44100 - ZAP C44200

Gilera Ice 50 Kat	ZAPC3000 - ZAPC300 - C30 - ZAPC30
Aprilia Scarabeo 50 Street	ZD4TH - TH - ZD4SCA - TH Var.G Vers.00



◀ cod. **9932990**
Scarico "Powered 2" Aprilia SR Factory (Piaggio)

APPLICABILITÀ

Aprilia Sr 50 Factory Kat I.E.	ZD4VFD - TE Var.A Vers.00 - ZDTEA
--------------------------------	-----------------------------------

Gilera Runner 50 Pure Jet	C46 Var.2 Vers.00 - (ZAP) C462
---------------------------	--------------------------------



◀ **cod. 9933300**
Scarico "HP2" Aprilia SR (Piaggio)

APPLICABILITÀ

Aprilia Sr 50 Sport Pro Kat I.E.	(ZD4) TE00 / (ZAP) TE00
Aprilia Sr 50 Factory Kat	ZD4VFD - TE var.A ver.00 - ZDTEA

Piaggio Nrg 50 Power Dd Kat	ZAPC45100 - C45 var.1 ver.00
Gilera Runner 50 Sp	C46 var. 1 ver.00 - (ZAP) C461 - C46 var. 2 ver.00



◀ **cod. 9933310**
Scarico "HP2" Piaggio NRG

APPLICABILITÀ

Piaggio Nrg Mc2 (Liquid)	C21100 - C210 - C21000 - C220 - C22000 - C22100 - C041 - C18
Piaggio Nrg Mc2 (Air)	C21100 - C210 - C21000 - C220 - C22000 - C041 - C18

Derbi Atlantis 50	AL1BE2 - AL Vers.E2 Var.1A
-------------------	----------------------------



◀ **cod. 9933320**
Scarico "HP2" Malaguti F12

APPLICABILITÀ

Malaguti F12 Phantom (Liquid Cooled)	ZJM41 - ZJM41 - 46 - 46000046
Malaguti F12 Phantom (Aircooled)	ZJM40/D - ZJM40 - 46 - 46000046

Malaguti F12 Phantom Kat (Air Cooled)	ZJM4600000 - ZJM46 - 46
Malaguti F12 Phantom Kat (Liquid Cooled)	47/K 1/02 - ZJM47 - ZJM4700000 - 47 - ZJM47



◀ **cod. 9933330**
Scarico "HP2" Gilera Typhoon

APPLICABILITÀ

Gilera Storm	TEC1T
Gilera Typhoon	TEC1T - TEC2T

Piaggio Zip 50 Fast Rider	SSP1T - ZAPC07000 - SSL1T
Gilera Typhoon 50	C48 var.1 ver.00



◀ **cod. 9933340**
Scarico "HP2" Peugeot Speedfight

APPLICABILITÀ

Peugeot Speedfight (Liquid)	S1B00-B - VGAS1B00B - VGA-S1B00A - S1B - S1BDE - S1BKB - S1BOKB
Peugeot Speedfight (Air)	S1B - VGAS1 - BOKKA - S1BDE - S1BOKA - S1BOKA - S1BOKF

Peugeot X-Fight 50 Kat	S1 Var. 3B Vers. A4
------------------------	---------------------



◀ cod. **9933350**
Scarico "HP2" Peugeot Squab

APPLICABILITÀ

Peugeot Buxi M 50	S1A
Peugeot Metal - X 50	S1AOKF
Peugeot Squab 50	S1A - VGASTA01

Peugeot Trekker 50	S1A - VGASTA00
Peugeot Vivacity 50	S1C - S1COKF - S1COKA - S1A - VGASTCAAAA



◀ cod. **9933360**
Scarico "HP2" Yamaha Aerox

APPLICABILITÀ

Mbk Nitro	5BR - SBR0000
Yamaha Aerox 50	5BR - SBR0000

Yamaha Aerox 50 Kat	5SB - SA14 - SA144 - SA14 var.1 ver.III
---------------------	---



◀ cod. **9933370**
Scarico "HP2" MBK Booster FINO AL 2004

APPLICABILITÀ

Mbk Booster 50	3WW (CW50) - 4BX - 4PA1 - 4WW - VG5SA062001 - 5LE2
Mbk Booster 50 Kat	5NT - VG5SA - 5SX - 5SX1
Mbk Booster 50 Next Generation	4TD - 4SB - 4VA - VG5SA052001 - 5LF1
Mbk Booster Next Generation 50 Kat	5FL - 5NU
Mbk Spirit	SA06
Mbk Spirit Kat	5LE - 5MM
Mbk Stunt	SLH
Mbk Rocket	4SB - 4VA

Yamaha Bw's Kat	SA051 - SA052 - SA054 - SA055 - SA056 - SA057 - SA058 - 5NT - VG5SA - 5SX - 5SX1
Yamaha Bw's Next Generation Kat	5FL - 5NU
Yamaha Bw's 50	3WW (CW50) - 4BX - 4VU2 - VG5SA061001 - 5LE1 - VGASA056 - VGASA057
Yamaha Bw's Next Generation Kat	4TD - 4SB/4VA - VG5SA - 5LF1 - NP4YB200 - 4VA
Yamaha Slider 50 Kat	SA09 - SA - SA091
Yamaha Spy	4UP



◀ cod. **9933380**
Scarico "HP2" Aprilia SR Stealth

APPLICABILITÀ

Aprilia Sr 50 Stealth	MZF1 - ZD4MZC
Aprilia Sr 50 Racing	MZF1 - ZD4MZC
Malaguti F 15 Firefox (Liquid Cooled)	44 ver. B2 var. K1

Mbk Nitro 50 Kat	SA14 - 5SB
Yamaha Aerox 50 Kat	SA14 - SA141 - 5BR - 5SB



◀ cod. **9933400**
Silenziatore a ricambio per tutti gli scarichi HP2



cod. **9930140** **RACING**

Scarico "TPR" GP Minarelli/Yamaha

Da abbinare ai Maxi Kit Scooter 50cc. Minarelli/Yamaha LC | cod.9926560 e 9926580

APPLICABILITÀ

Aprilia Area 51 50 2T 98-00, Gulliver LC 50 2T 96-98, Rally Liquid Cooled 50 2T 96-99, SR Liquid Cooled 50 2T 94-96, SR Recing 50 2T 97-99, SR Stealth 50 2T 97-99, Sonic GP 50 2T 98-08

Benelli 491 RR 50 2T 99-01, 491 Racing 50 2T 98-99, 491 SP 50 2T 99-99, 491 Sport 50 2T 98-99, K2 Liquid Cooled 50 2T 98-01

Beta Ark LC 50 2T 96-08, Eikon 50 2T 99-03

Italjet Dragster 50 2T -00

Malaguti F12 Phantom LC 50 2T -00, F12 R Phantom LC 50 2T 07-09, F15 Firefox 50 2T -00, F15 Firefox Euro 2 50 2T 02-06, F15 Firefox Euro 2 2,3 50 2T 03-04

Mbk Mach G LC 50 2T 02-04, Nitro 50 2T -00, Nitro Euro 2 50 2T 03-03

Yamaha Aerox 50 2T -00, Aerox Euro 2 50 2T 03-03, Jog R LC 50 2T -00

RICAMBI

9930550	Kit staffa fissaggio
9930590	Kit collettore

9930670	Silenziatore
9930680	Serie guarnizioni



cod. **9930160** **RACING**

Scarico "TPR" GP Piaggio

Da abbinare ai Maxi Kit Scooter 50cc. Piaggio | cod. 9928390 e 9928340

APPLICABILITÀ

Aprilia SR R 50 2T 04-09, SR R FACTORY Carburatore 50 2T -, SR R FACTORY IE 50 2T

Derbi GP1 50 2T 01-03, GP1 EU2 50 2T 05-05, GP1 Open EU2 50 2T 06-09, GP1 Race EU2 50 2T 05-07

Gilera DNA 50 2T 00-02, DNA 50 2T 05-07, DNA GP Experience 50 2T 03-04, Runner 50 2T 97-00, Runner Poggiali 50 2T 02-02, Runner SP 50 2T 02-07, Runner SP 50 2T 10-12, Runner SP ST & Simoncelli 50 2T 08-09, Runner SP Special Edition 50 2T 07-07

Piaggio NRG 50 2T 94-96, NRG Extreme 50 2T 99-00, NRG MC3 50 2T 01-04, NRG Power DD 50 2T 05-13, NRG Power DD Serie Speciale 50 2T -, NRG RST MC2 50 2T 96-98, NTT 50 2T 95-96, Quartz 50 2T 92-96, Zip 2T 50 2T -, Zip LC 50 2T 00-04, Zip Sp 50 2T 96-04, Zip Sp Euro 2 50 2T

RICAMBI

9930670	Silenziatore
9930680	Serie guarnizioni

9930730	Kit staffa fissaggio
9930750	Kit collettore

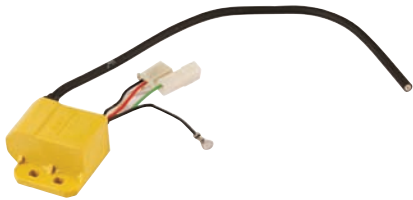

◀ **cod. 9910090**
Centralina ad anticipo fisso 6 poli Ducati

APPLICABILITÀ

Beta Ark 50 2T 96-08, Ark LC 50 2T 96-08, Chrono 50 2T 96-00, Quadra 50 2T 95-00, Tempo 50 2T 95-00
KTM K50 50 2T -00
Macal Sting 50 2T -00, Thunder 50 2T -00

Malaguti Centro 50 2T -00, Ciak 50 2T -00, Ciak Euro2 50 2T 01-03, F10 50 2T -00, F10 Euro 2 50 2T -00, F12 Phantom 50 2T -00, F12 Phantom LC 50 2T -00, F12 Restyling Euro 1 50 2T 99-02, F15 Firefox 50 2T -00, Yesterday 50 2T 97-00
Motron Sting 50 2T -00, Syncro 50 2T -00, Thunder 50 2T -00



◀ **cod. 9910150**
Centralina ad anticipo fisso 6 poli per motori Minarelli AM

APPLICABILITÀ

Aprilia Classic 50 2T 92-99, Europa 50 2T 91-92, MX 50 50 2T 04-04, MX 50 Motard 50 2T 95-03, Pegaso 50 2T 92-94, RS 50 50 2T 91-05, RX 50 50 2T 03-04, RX 50 3-5 Marce 50 2T 91-94, RX 50 Enduro 50 2T 95-03, RX 50 Racing 50 2T 03-06, Tuono 50 50 2T 03-04
Beta RR Alu 50 2T 00-, RR Enduro 50 50 2T 00-, RR Motard 50 50 2T 00
CH Husqvarna SM 50 50 2T -00, WR 50 50 2T -00, WSM 50 50 2T -00
HM CRE Six, Baia, Derapage 50 2T 95-05
Malaguti CNK Drakon 50 2T 05-07, Fifty Evolution 50 2T 90-93, XSM 50 50 2T -00, XTM 50 50 2T -00
Mbk X Limit 50 2T -00, X Power 50 2T -00
Minarelli AM 345 Motori Minarelli 50 2T -00

Motor Furia 50 50 2T -00, Furia Max 50 50 2T -00, RX 50 50 2T -00, RX 50 R 50 2T -00
Hispania
Peugeot Supermotard 50 2T -00, XP6 Trail S/Avv. Elettrico 50 2T -00, XR6 Racing Cat. C/avv.elett. 50 2T -00
Rieju MRT 50 50 2T -00, MRT 50 PRO 50 2T -00, MRT 50 PRO SM 50 2T -00, MRT 50 SM 50 2T -00, MRX 50 50 2T -00, MRX 50 PRO 50 2T -00, RR 50 50 2T -00, RS1 50 50 2T -00, RS2 50 Matrix 50 2T -00, RS2 50 Matrix Pro 50 2T -00, RS2 Naked 50 50 2T -00, SMX 50 E.S./K.S. 50 2T -00, SMX 50 PRO E.S./K.S. 50 2T -00, Spike 50 50 2T -00
Sherco HRD Enduro 50 50 2T -00, HRD Motard 50 50 2T -00
Yamaha DT R 50 2T 03-06, DT RSM 50 2T 03-05, DT X 50 2T 06-06

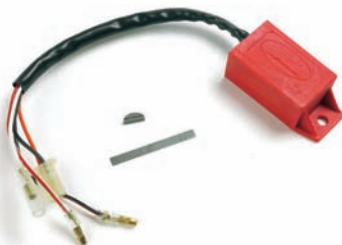

◀ **cod. 9909230**
Centralina ad anticipo variabile per motore orizzontale (Japan)

APPLICABILITÀ

Aprilia Area 51 50 2T 98-00, Gulliver 50 2T 95-98, Gulliver LC 50 2T 96-98, Rally 50 2T 95-03, Rally Liquid Cooled 50 2T 96-99, SR (Orizzontale) 50 2T 94-96, SR Liquid Cooled 50 2T 94-96, SR Recing 50 2T 97-99, SR Stealth 50 2T 97-99, SR WWW 50 2T 97-01, Scarabeo 50 2T 93-05, Sonic 50 2T 98-07, Sonic GP 50 2T 98-08
Benelli 491 GT 50 2T 98-99, 491 RR 50 2T 99-01, 491 Racing 50 2T 98-99, 491 SP 50 2T 99-99, 491 ST 50 2T 99-01, 491 Sport 50 2T 98-99, K2 50 2T 98-01, K2 Liquid Cooled 50 2T 98-01, Naked 50 2T 02-02, Pepe 50 2T 99-01, Pepe LX 50 2T 03-04
Beta Chrono 50 2T -00, Quadra 50 2T -00, Tempo 50 2T -00

Italjet Dragster 50 2T -00
Mbk Booster 50 2T -00, Booster NG 50 2T -00, Booster Rocket 50 2T 97-98, Booster Spirit 50 2T -00, Booster Track 50 2T 96-98, Evolis 50 2T 92-95, Fizz 50 2T 94-95, Flipper 50 2T -00, Nitro 50 2T -00, Ovetto 50 2T -00, Stunt 50 2T 00-02
Yamaha Aerox 50 2T -00, Axis 50 2T 95-96, BWS 50 2T -00, BWS Bump 50 2T 97-98, BWS NG 50 2T -00, Breeze 50 2T 94-95, Jog 50 2T -00, Jog ER 50 2T -00, Jog Z 50 2T 95-95, Neo's 50 2T -00, Slider 50 2T 00-02, Spy 50 2T 95-98, Why 50 2T -00, Zest 50 2T -00, Zuma 50 2T 97-01

RICAMBI

9909180	Chiavetta disassata per anticipo variabile
---------	--



◀ **cod. 9912500**
Centralina ad anticipo variabile

APPLICABILITÀ

Peugeot Buxy 50 2T -00, Buxy RS 50 2T -00, Speedake 50 2T -00, Speedfight 50 2T -00, Zenith 50 2T -00

RICAMBI

9912490	Chiavetta disassata
---------	---------------------



◀ **cod. 9909300**
Centralina ad anticipo variabile per volano Ducati

APPLICABILITÀ

Beta Ark 50 2T 96-08, Ark LC 50 2T 96-08, Chrono 50 2T 96-96, Quadra 50 2T 95-95, Tempo 50 2T 95-95
KTM K50 50 2T -00
Macal Sting 50 2T -00, Thunder 50 2T -00

Malaguti Centro 50 2T -00, Ciak 50 2T -00, Ciak Euro2 50 2T 01-03, F10 50 2T -00, F10 Euro 2 50 2T -00, F12 Phantom 50 2T -00, F12 Phantom LC 50 2T -00, F12 Restyling Euro 1 50 2T 99-02, F15 Firefox 50 2T -00, Yesterday 50 2T 97-00
Motron Sting 50 2T -00, Syncro 50 2T -00, Thunder 50 2T -00

RICAMBI

9909180	Chiavetta disassata per anticipo variabile
---------	--

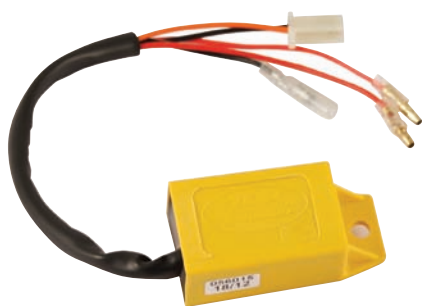

◀ **cod. 9910100**
Centralina ad anticipo fisso per motori scooter 50 cc Minarelli/Yamaha

APPLICABILITÀ

- Aprilia** Area 51 50 2T 98-00, Gulliver 50 2T 95-98, Gulliver LC 50 2T 96-98, Rally 50 2T 95-03, Rally Liquid Cooled 50 2T 96-99, SR (Orizzontale) 50 2T 94-96, SR Liquid Cooled 50 2T 94-96, SR Recing 50 2T 97-99, SR Stealth 50 2T 97-99, SR WWW 50 2T 97-01, Scarabeo 50 2T 93-05, Sonic 50 2T 98-07, Sonic GP 50 2T 98-08
- Benelli** 491 GT 50 2T 98-99, 491 RR 50 2T 99-01, 491 Racing 50 2T 98-99, 491 SP 50 2T 99-99, 491 ST 50 2T 99-01, 491 Sport 50 2T 98-99, K2 50 2T 98-01, K2 Liquid Cooled 50 2T 98-01, Naked 50 2T 02-02, Pepe 50 2T 99-01, Pepe LX 50 2T 03-04
- Beta** Chrono 50 2T -00, Eikon 50 2T 99-03, Quadra 50 2T -00, Tempo 50 2T -00
- Italjet** Dragster 50 2T -00

- Mbk** Booster 50 2T -00, Booster NG 50 2T -00, Booster Rocket 50 2T 97-98, Booster Spirit 50 2T -00, Booster Track 50 2T 96-98, Evolis 50 2T 92-95, Fizz 50 2T 94-95, Flipper 50 2T -00, Nitro 50 2T -00, Ovetto 50 2T -00, Stunt 50 2T 00-02
- Yamaha** Aerox 50 2T -00, Axis 50 2T 95-96, BWS 50 2T -00, BWS Bump 50 2T 97-98, BWS NG 50 2T -00, Breeze 50 2T 94-95, Jog 50 2T -00, Jog ER 50 2T -00, Jog Z 50 2T 95-95, Neo's 50 2T -00, Slider 50 2T 00-02, Spy 50 2T 95-98, Why 50 2T -00, Zest 50 2T -00, Zuma 50 2T 97-01



◀ **cod. 9921690**
Centralina digitale ad anticipo variabile per motori Minarelli AM6 con volano Ducati 6 poli

APPLICABILITÀ

- Aprilia** Classic 50 2T 92-99, Europa 50 2T 91-92, MX 50 50 2T 04-04, MX 50 Motard 50 2T 95-03, Pegaso 50 2T 92-94, RS 50 50 2T 91-05, RX 50 50 2T 03-04, RX 50 3-5 Marce 50 2T 91-94, RX 50 Enduro 50 2T 95-03, RX 50 Racing 50 2T 03-06, Tuono 50 50 2T 03-04
- Beta** RR Alu 50 2T 00-, RR Enduro 50 50 2T 00-, RR Motard 50 50 2T 00
- CH Husqvarna** SM 50 50 2T -00, WR 50 50 2T -00, WSM 50 50 2T -00
- Fantic** Caballero Motard 50 2T 06-10, Caballero Regularità 50 2T 06-10
- HM** CRE Six, Baia, Derapage 50 2T 95-05
- Malaguti** CNK Drakon 50 2T 05-07, Fifty Evolution 50 2T 90-93, XSM 50 50 2T -00, XTM 50 50 2T -00
- Mbk** X Limit 50 2T -00, X Power 50 2T -00

- Minarelli** AM 345 Motori Minarelli 50 2T -00
- Motor** Furia 50 50 2T -00, Furia Max 50 50 2T -00, RX 50 50 2T -00, RX 50 R 50 2T -00
- Hispania**
- Peugeot** Supermotard 50 2T -00, XP6 Trail S/Avv. Elettrico 50 2T -00, XR6 Racing Cat. C/avv.elett. 50 2T -00
- Rieju** MRX 50 50 2T -00, MRX 50 PRO 50 2T -00, RR 50 50 2T -00, RS1 50 50 2T -00, RS2 50 Matrix 50 2T -00, RS2 50 Matrix Pro 50 2T -00, RS2 Naked 50 50 2T -00, SMX 50 E.S./K.S. 50 2T -00, SMX 50 PRO E.S./K.S. 50 2T -00, Spike 50 50 2T -00
- Sherco** HRD Enduro 50 50 2T -00, HRD Motard 50 50 2T -00
- Yamaha** DT R 50 2T 03-06, DT RSM 50 2T 03-05, DT X 50 2T 06-06



◀ **cod. 9924870**
Centralina con bobina ad anticipo fisso

APPLICABILITÀ

- Gilera** DNA 50 2T 00-02, DNA 50 2T 05-07, DNA GP Experience 50 2T 03-04, Easy Moving 50 2T 95-96, Ice 50 2T 01-05, Runner 50 2T 97-00, Runner Poggiali 50 2T 02-02, Runner SP 50 2T 02-07, Runner SP 50 2T 10-12, Runner SP ST & Simoncelli 50 2T 08-09, Runner SP Special Edition 50 2T 07-07, Stalker 50 2T 97-11, Stalker Naked 50 2T 08-08, Stalker Special Edition 50 2T 07-08, Storm 50 2T 94-95, Typhoon 50 2T 94-97, Typhoon X 50 2T 98-99, Typhoon XR 50 2T 00-00
- Italjet** Jet Set 50 2T -00, Torpedo New 50 2T -00

- Piaggio** Free 50 2T 92-94, Free Delivery 50 2T 00-01, Free FL 50 2T 95-02, Liberty 50 2T 97-05, NRG Extreme 50 2T 99-00, NRG MC3 50 2T 01-04, NRG Power DT 50 2T 06-11, NRG Power DT Serie Speciale 50 2T 07-08, NRG RST MC2 50 2T 96-98, NTT 50 2T 95-96, Quartz 50 2T 92-96, Sfera 50 2T 91-93, Sfera Maquillage 2 50 2T 94-94, Sfera RST 50 2T 95-97, Vespa ET2 50 2T 97-05, Zip 50 2T 92-93, Zip 50 2T 95-96, Zip Bimodale 50 2T 94-97, Zip Fast Rider 50 2T 93-94, Zip Fast Rider RST 50 2T 96-97, Zip RST 50 2T 96-99, Zip Sp 50 2T 96-00



◀ **cod. 9924880**
Centralina con bobina ad anticipo variabile

APPLICABILITÀ

- Gilera** DNA 50 2T 00-02, DNA 50 2T 05-07, DNA GP Experience 50 2T 03-04, Easy Moving 50 2T 95-96, Ice 50 2T 01-05, Runner 50 2T 97-00, Runner Poggiali 50 2T 02-02, Runner SP 50 2T 02-07, Runner SP 50 2T 10-12, Runner SP ST & Simoncelli 50 2T 08-09, Runner SP Special Edition 50 2T 07-07, Stalker 50 2T 97-11, Stalker Naked 50 2T 08-08, Stalker Special Edition 50 2T 07-08, Storm 50 2T 94-95, Typhoon 50 2T 94-97, Typhoon X 50 2T 98-99, Typhoon XR 50 2T 00-00
- Italjet** Jet Set 50 2T -00, Torpedo New 50 2T -00

- Piaggio** Free 50 2T 92-94, Free Delivery 50 2T 00-01, Free FL 50 2T 95-02, Liberty 50 2T 97-05, NRG Extreme 50 2T 99-00, NRG MC3 50 2T 01-04, NRG Power DT 50 2T 06-11, NRG Power DT Serie Speciale 50 2T 07-08, NRG RST MC2 50 2T 96-98, NTT 50 2T 95-96, Quartz 50 2T 92-96, Sfera 50 2T 91-93, Sfera Maquillage 2 50 2T 94-94, Sfera RST 50 2T 95-97, Vespa ET2 50 2T 97-05, Zip 50 2T 92-93, Zip 50 2T 95-96, Zip Bimodale 50 2T 94-97, Zip Fast Rider 50 2T 93-94, Zip Fast Rider RST 50 2T 96-97, Zip RST 50 2T 96-99, Zip Sp 50 2T 96-00

RICAMBI

9909940	Chiavetta disassata
---------	---------------------



◀ **cod. 9921210**
Centralina digitale ad anticipo variabile per scooter 50 cc

APPLICABILITÀ

Malaguti Ciak Euro 2,2,3 50 2T 03-03, F10 Euro 2,2,3 50 2T 03-04, F12 Phantom Euro 2,2,3 50 2T 03-04, F12 Phantom LC Euro 2,2,3 50 2T 03-04, F15 Firefox Euro 2,2,3 50 2T 03-04



◀ **cod. 9921790**
Centralina digitale ad anticipo variabile per motori scooter 50 cc Minarelli/Yamaha

APPLICABILITÀ

Mbk Booster Euro 2 50 2T 04-04, Booster NG 50 2T 03-03, Booster Spirit 50 2T 03-03, Flipper Euro 2 50 2T 03-03, Mach G 50 2T 02-04, Mach G LC 50 2T 02-04, Nitro Euro 2 50 2T 03-03, Ovetto Euro 2 50 2T 02-02

Yamaha Aerox Euro 2 50 2T 03-03, BWS Euro 2 50 2T 03-03, BWS NG Euro 2 50 2T 03-03, Jog R 50 2T 02-10, Jog R LC 50 2T -00, Neo's Euro 2 50 2T 02-02, Why Euro 2 50 2T 03-03



◀ **cod. 9925780**
Centralina digitale ad anticipo variabile F12 EU2 dal'06

APPLICABILITÀ

Malaguti Ciak Master Euro 2 50 2T 06-06, F10 Restyling Euro 2 50 2T 06-06, F12 R Phantom LC 50 2T 07-09, F12 Restyling Euro 2 50 2T 06-06, F12 Restyling LC Euro 2 50 2T 06-06, F15 Firefox Euro 2 50 2T 04-06



◀ **cod. 9926150**
Centralina digitale ad anticipo variabile per Piaggio 50 4T

APPLICABILITÀ

Piaggio Fly 4T 50 4T 05-07, Fly 4T & 25-30 KM/H 50 4T 08-11, Fly 4T Motore CHN 50 4T 06-07, Liberty 4T 50 4T 00-02, Liberty 4T 50 4T 05-08, Liberty 4T Delivery - Single 50 4T 10-12, Liberty 4T Delivery TNT 50 4T 09-09, Liberty 4T PTT - DOUBLE 50 4T 09-12, Liberty 4T RST 50 4T 04-04, Liberty 4T Sport 50 4T 06-08, Liberty MOC 4T & Elle 50 4T 09-13, Vespa ET4 50 4T 00-05, Vespa LX 4T 50 4T 05-08, Zip 4T 50 4T 00-13



◀ **cod. 9921850**
Centralina digitale ad anticipo variabile per scooter 50 cc

APPLICABILITÀ

Malaguti F12 Phantom Euro 2 (fino al '06), F15 Firefox Euro 2 ('02 - '03)



◀ **cod. 9922900**
Cappuccio candela con resistore

KIT DI PROGRAMMAZIONE



◀ cod. **9927340**

Kit programmazione centralina TFI

Per programmare le centraline iniezione. Consente la sostituzione delle mappe di iniezione all'interno delle centraline.

APPLICABILITÀ

Mbk Cityliner 125 EU3 125 4T-4V 08-10, Skycruiser 125 125 4T-4V 07-07

Yamaha WR-R IE 125 4T 4V IE 09-11, WR-X IE 125 4T 4V IE 09-11, WR-X IE 125 4T 4V IE 13-14, X-City 125 EU3 125 4T-4V 08-11, X-Max R 125 125 4T-4V 06-16, X-Max R 125 ABS 125 4T-4V 11-11, X-Max RA 125 ABS 125 4T-4V 13-16, YZF-R IE 125 4T 4V IE 08-13

REGOLATORE DI PRESSIONE



◀ cod. **9928130**

Regolatore di pressione 3.5 bar

APPLICABILITÀ

Mbk Booster X ie 50 4T-3V 08-08

Yamaha Giggie 50 4T-3V 08-08, YZF-R IE 125 4T 4V IE 08-13, T-Max 4B5 500 500 4T 09-11, T-Max 4B5 ABS 500 500 4T 08-11, T-Max 5VU 500 500 4T 06-06, T-Max 5VU 500 500 4T 08-08

CONTAGIRI



◀ cod. **9931400**

Contagiri digitale con contaore

CARICA BATTERIE



◀ cod. **9934160**
Professional Battery Charger

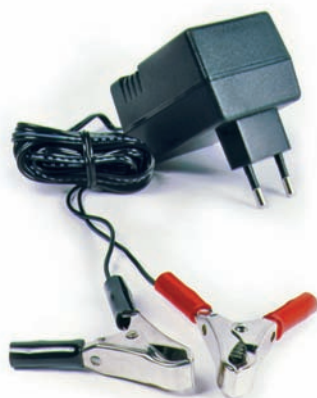

◀ cod. **9980060**
Carica batterie 12V per scooter

CARICATORI USB



◀ cod. **9980070**
Caricatore USB Presa Singola (2A - Cavo 0,5 m)



◀ cod. **9980080**
Caricatore USB Presa Doppia (5A - Cavo 3 m)

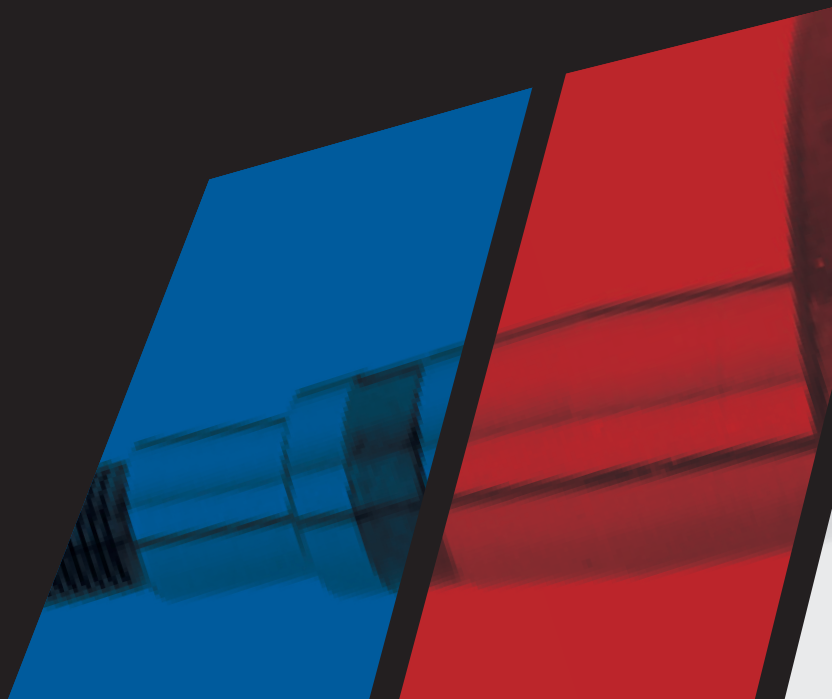

spare parts

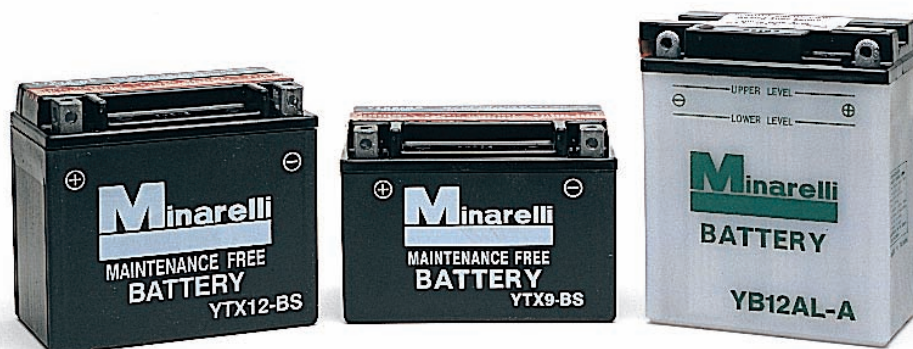

MINARELLI

Codice	Sigla	Ah	Poli	Lunghezza	Larghezza	Altezza
0012180	YB4L-B	4	- +	120	70	92
0012240	YB5L-B	5	- +	120	60	130
0012250	YB9-B	9	+ -	136	76	135
0012260	YB10L-A2	11	- +	134	90	146
0012310	YTX4L-BS	3	- +	112	71	86
0012320	YTX12-BS	10	+ -	150	87	130
0012330	YTX9-BS	8	+ -	150	87	105
0012340	YB12AL-A	12	- +	133	80	160
0012350	YTX7A-BS	6	+ -	150	87	96
0012360	YTR4A-BS	2,3	+ -	113	48	85
0012380	YTX5L-BS	4	- +	112	70	105
0012390	YTX14-BS	12	+ -	150	87	147
0012410	YB7L-B	8	- +	137	76	135
0012420	YB7L-B2	8	- +	136	76	132
0012430	YTX7L-BS	6	- +	112	70	128
0012470	YT12A-BS	10	+ -	150	87	106
0012480	YB10L-B	11	- +	134	90	145
0012490	YB14-A2	14	+ -	134	89	166
0012500	YTZ7S-BS	6	- +	114	70	105
0012510	YTZ12S-BS	11	+ -	150	87	110
0012520	YT7B-BS	6	+ -	150	65	95
0012530	YT9B-BS	8	+ -	150	70	105
0012540	YTZ10S	8,5	+ -	150	87	95
0012550	YT12B-BS	10	+ -	150	69	132
0012560	52015	22	- +	181	77	173
0012570	YB10L-BP	12	- +	134	90	145
0012580	YTZ14S-BS	11,2	+ -	150	87	110
0012590	YB14L-A2	14	- +	134	89	166

MINARELLI

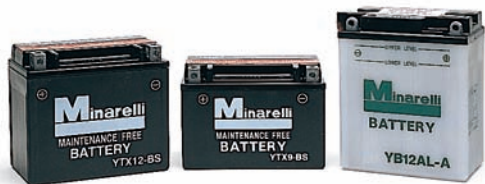

cod. Batteria YB4L-B

APPLICABILITÀ

Agrati Agrati Garelli Moped Cc.100

Garelli

Aprilia AF-1 Futura/Europa cc.50 - 87-94, Amico GL/LK/LX/Sport cc.50 - 92-97, AREA 51 cc.50 - 98-00, Classic50 cc.50 - 92-99, Custom cc.125 -, ET cc.50, Gulliver AC/LC cc.50 - 95-98, H2O cc.50 - 00-, Habana, Custom cc.50 - 99, LC cc.50, Mc Gulliver cc.50 - 00-, Mojito cc.50 - 04-08, Mojito 25 KM/H FL cc.50 -, Mojito custom/retro cc.50 - 99-07, Mojito FL cc.50 -, Mx cc.50 - 04, MX-125 cc.125 - 04-06, Pegaso cc.50 - 92-94, Pegaso cc.50 - 00-, Rally cc.50 - 04-05, Rally AC/LC cc.50 - 95-03, Red Rose/Classic cc.50 - 89-92, Replica cc.50 - 00-, Rs cc.50 - 06-08, RS 50/Extrema cc.50 - 97-05, RS Replica cc.50 - 95-01, RS250 cc.250 - 00-04, RX 125 11 KW cc.125 -, RX 125 F.P. cc.125 -, RX-50 cc.50 - 89-07, Scarabeo cc.50 - 93-08, Sonic cc.50 - 98-07, Sonic Acqua cc.50 -, Sonic GP cc.50 - 98-08, SR Ditech cc.50 - 00-05, SR LC/Netscaper cc.50 - 97, SR Netscaper cc.50 - 97, SR Replica/Racing cc.50 - 97-00, SR Stealth/WWW cc.50 - 97-99, SR Street carburatore cc.50 - 03-08, SR Urban/Viper cc.50 - 00-10, SR50 cc.50 - 00-01, SR50 de cc.50 -, SX 11 KW cc.125 -, SX F.P. cc.125 -, Tuareg Rally/Wind cc.50 - 90-05, Tuono cc.50 - 03-04

Benelli 491 cc.50 - 98-04, 491 GT/Sport/Racing cc.50 - 97, 491 k2 cc.491, C2 Long St cc.50 - 81, Devil cc.80 - 94-95, Devil E-Starter cc.50 - 94-95, G2 cc.50 - 81-85, K2 cc.50 - 97-01, K2 cc.100 - 99-01, KBX cc.80 - 94, KBX Race cc.50 - 94, Naked cc.50 - 02-04, Pepe cc.50 - 99-04, Pepe cc.50 - 07, Scooty LX/DLX cc.50 - 94, Sprint cc.50 - 76

Betamotor Adventure cc.50, Ark Air Cooled cc.50 - 98-00, Ark Air/Ark Lc cc.50 - 96-07, Chrono cc.50 - 95, Eikon cc.50 - 99-03, Eikon, Afrika cc.125 - 00-02, Fhrona cc.50, Quadra cc.50 - 95-99, Squirrer cc.50 - 98-00, Supermoto cc.75 - 00-01, Tempo cc.50 - 94-99

Cagiva Cosis, Prima, Mantis, Supercity cc.50, GT Progress, Corsa 50 cc.50 - 98, K 7 Passing cc.125, K3, W4 cc.50 - 98, Mito cc.50 - 98-99, Muntis 50 cc.50 - 99, W 8 cc.50, W4 6V cc.50 - 92-95, W8 cc.125 - 93-98

Daelim Daelim Reiju Cc.125

Derbi Atlantis cc.50 - 99-07, Aventura, Furax, Hunter cc.50 - 96-97, Easy 50 cc.50 - 97, Fenix cc.50 - 94, Furax cc.50 - 96, Gp1 cc.50 - 01-03, Gp1 Eu2, Race cc.50 - 05-07, Gp1 Open cc.50 - 06-08, GPR 50 Racing cc.50 - 11-, Gpr Nude, Touning, Sport cc.50 - 99-07, Gpr R cc.50 - 97-00, Gpr Racing, E2, R E2, cc.50 - 04-06, Gpr Replica, cc.50 - 05-07, Gpr Replica, cc.50 - 99-03, Hunter cc.50 - 96-97, Paddock cc.50 - 97-99, Predator, LC, 02 cc.50 - 98-01, Senda DRD Pro 50 R cc.50 - 11-, Senda DRD Racing 50 R cc.50 - 11-, Senda DRD Racing 50 SM cc.50 - 11-, Senda DRD X-Treme 50 R cc.50 - 11-, Senda DRD X-Treme 50 SM cc.50 - 11-, Senda-L, Senda-R cc.50 - 94-, Sport cc.50 - 97, Vamos cc.50 - 93-, Variant-GS cc.50 - 97

Fantic HP 1 cc.50, Koala cc.50 - 93-97, Koala cc.80 - 93-96, Noi (Electric-Start) cc.50, Oasis cc.50, Pony, SR cc.50 - 95

Garelli Big Racing cc.50 - 94, Big Wheel cc.50 - 94-95, Big Wheel cc.50 - 10-, Noi cc.50, Pony, Pony SR cc.50 - 94-95, Sahel, Team, Urka cc.50 - 10-, VIP cc.50 - 10-, XLE Tiger cc.50

Gilera 503 cc.50 -, Bullit, Easy Moving, Runner cc.50 - 97, Eaglelet cc.50 - 95-97, Easy Moving cc.50 - 95-96, GSA EL-Starter cc.50, GSM cc.50 - 99-01, RCR cc.50 - 06-07, RK C-bal cc.50 - 96-98, Runner cc.50 - 97, Runner SP cc.50 - 02-08, Sioux EL - Starter cc.50, SMT cc.50 - 06-07, Stalker, Storm, Top Rally cc.50 - 97-08, Top Rally cc.50, Typhoon, X cc.50 - 94-00, Zulu cc.50 - 01

Hercules Gipsy cc.50 - 95, KX5 cc.50 - 93-97, Limbo L, M, MA, ML cc.50 - 95-97, Reggagge, Reggagge, splinter cc.50 - 96-97, Samba, Swing cc.50 - 94-97, Squab cc.50 - 97, ZX cc.50 - 95-97

Honda CS05W cc.50 - 94, C70CMP cc.70 - 97, C70W cc.70 - 95, C90, CW cc.90 - 95, Fifty cc.50, Lead cc.50, NB 50 M cc.50 - 82, NBSOM Aero cc.50 - 83-84, ND50 M cc.50 - 82, NH 50 MS cc.50 - 86-98, NNSOMD Gyro cc.50 - 84, NP50, M SKY cc.50 - 97, NQ 50, M cc.50 - 85, NQ50 Spree cc.50 - 84-85, NT110MV cc.110 - 97, NU 50M Urban Exp. Delux cc.50 - 82-83, NX 50M Express SR cc.50 - 81-82, NZ110 MM cc.110 - 93, PX 50 MS cc.50 - 84, PXR cc.50, SH 50 cc.50 - 87-89, HYOSUNG, HYOSUNG Avanti, Challenger, Racing, Rush cc.50

Italjet Bazooka, 2 cc.50, Cruise cc.50, Dragster cc.50 - 97, Formula cc.50 - 95-97, Formula cc.50 - 97-, Jet Set cc.50 - 01-03, Pista cc.50 - 80-95, Reporter cc.50, Scoop cc.50, Techno Air cc.50, Torpedo cc.50 - 97-03, Velocifero cc.50 - 93-99

Kawasaki KL250 D2-D16 cc.250, KL600A KLR (Kick-Starter) cc.600 - 89-90, KMX125 A1-A8, A11 cc.125 - 86-, KMX125 B1-B9 cc.125 - 91-, KMX200 A2-A5 cc.200 - 97, KR250 B, C, KR, 15 cc.250 - 92

Ktm KTM Kross cc.50 -

Malaguti Centro, SL cc.50 - 94-, CIAK cc.50 - 99, Colors cc.50, CR1 cc.50 - 96-, Crosser cc.50, Dune ES cc.50 - 89, Evolution cc.50, F10 cc.50, F10, F12/F12LC cc.50, F12LC Twin Disk cc.50, F15 Twin Disk/Digit cc.50, F15/F15 Twin Disk cc.50, Fitty Top cc.50 - 91, Grosser EL cc.50 - 98, Mistral cc.50, New Dribbling cc.50, Phantom F.12 cc.50, RST cc.50, RST cc.90, Top cc.50, XMS cc.50 - 03-08, XTM cc.50 - 03-08, Yesterday, EURO cc.50

MBK Active cc.50, Booster cc.50 - 93-96, Booster cc.100 - 01, CR Z cc.50, CT S cc.50, Equalis cc.50 - 99, Evolis cc.50 - 93-97, Evolis cc.80 - 95-98, EW cc.50, Fizz cc.50 - 95-96, Flipper cc.50 - 01, Forte cc.50 - 96-97, Match G cc.50, Nitro cc.50 - 99, Nitro cc.100 - 01, Ovetto cc.50 - 99, Ovetto cc.100 - 01, Sorriso cc.50, Stunt cc.50 - 01, Target cc.50, X-Limit cc.50 - 03, X-Limit DT50 cc.50 - 97

Motobecane Active cc.80, Booster, Hot Champ cc.50, Moped, Target cc.50

Motron Compact Racing RZ1 cc.50, Invader cc.50, Spike cc.50, Sting cc.50, Syncro cc.50, Thunder cc.50, XLE cc.50

Peugeot Buxy cc.50 - 95-97, Buxy RS cc.50 - 96-97, Cidomotore (Electric-Starter) cc.105 - 01-, Cidomotore(E-Starter) cc.125 - 01-, Elysee cc.50 - 98, FOX LA cc.25 - 95-97, FOX Lux cc.50 - 95-97, Jet Force cc.50 - 03, Liberty cc.50 -, Looxor cc.50 - 01-, Ludix cc.50 - 04-06, Metal X cc.50 - 02, Rapido/Rapido 3 cc.50 - 01-, SC80LI (Metropolis) cc.80, SCLLI Metropolis cc.50 - 01-, Speedake cc.50 - 01-, Speedfight cc.50 - 97-99, Speedfight 2 cc.50 - 00-, Speedfight/LC cc.50 - 97-99, Squab cc.50 - 96-97, ST cc.50 - 01-, SV Blue Star cc.50 - 97, SV Junior cc.50 - 93-96, Trekker Road/Off Road cc.50 - 99, TRK2 WRC cc.50 - 04-06, Vivacity cc.50 - 99, X-Fight cc.50, X-Fight cc.100 - 01-, XPS cc.50 - 03-04, XRB cc.50 - 03-04, Xracc cc.50 - 03, Zenith cc.50 - 95-96, Zenith cc.100 - 01-

PGO Big Max cc.50 - 95-96, Big Max cc.90 - 97, Big Max cc.25, Big Max Sport cc.50 - 96-97, Comet cc.25 - 95-97, Comet cc.50 - 93-96, Comet Junior cc.50 - 94-97, Galaxy cc.25 - 97, Galaxy cc.50 - 93-97, Galaxy cc.90 - 94-97, Galaxy cc.80 - 93-96, Mega cc.25 - 97, Mega cc.50 - 97, Star cc.80 - 93-96, Star-Star II cc.50 - 93-96, Tornado cc.50 - 97, Tornado cc.90 - 97, Tornado cc.125

PGO Big Max cc.50 - 95-96, Big Max cc.90 - 97, Big Max cc.25, Big Max Sport cc.50 - 96-97, Comet cc.25 - 95-97, Comet cc.50 - 93-96, Comet Junior cc.50 - 94-97, Galaxy cc.25 - 97, Galaxy cc.50 - 93-97, Galaxy cc.90 - 94-97, Galaxy cc.80 - 93-96, Mega cc.25 - 97, Mega cc.50 - 97, Star cc.80 - 93-96, Star-Star II cc.50 - 93-96, Tornado cc.50 - 97, Tornado cc.90 - 97, Tornado cc.125

Piaggio Diesis cc.50 -, Easy Moving cc.50 -, ET-2 cc.50 - 97, Free, FD cc.50 - 94-99, Free, FL cc.25, Free, FL cc.50 - 94-99, Free, FL, Zip cc.25, Liberty cc.50 - 99, NRG cc.50 - 94-96, NRG Extreme cc.50 - 95-99, NRG MC2 cc.50 - 96-98, NRG MC3 cc.50 - 01-04, NRG Power DD/DT cc.50 - 05-07, NTT cc.50, Puch P1-TRE cc.50 - 93-98, Quartz cc.50 - 93-98, RCR cc.50 -, Runner SP Race cc.50 -, Runner SP SC cc.50 -, Runner SP, DD, FL cc.50 -, Scatto cc.50, Sfera cc.50 - 93-98, Sfera cc.80 - 93-95, Skipper cc.150, SMT cc.50 -, SP 50 cc.50 - 10-, Stalker 50 cc.50 -, Stalker Naked cc.50 -, Tph cc.50, Typhoon cc.50 - 94-08, Velofax cc.25 - 98, Velofax cc.50 - 98, Vespa LX 2T cc.50 - 05-08, Zip Bimodale cc.50 - 94-97, Zip FR/RST cc.50, Zip SP cc.50 - 96-08, Zip/Zip Fast Rider cc.50

Puch Rizzato Cobra GT, GTL cc.50, Lido SL, Lido Vario cc.50

Byte AT10 cc.50, Carosello cc.50 -, Hacker AT12, LC cc.50, Hacker AT12, LC/Racing cc.50 -

Simson SIMSON Spatz cc.50 - 01

Suzuki APS0, R7 cc.50 - 94-97, CP50 cc.50 - 85-95, DG80 cc.80 - 91, DR125, D, S cc.125, DR250S cc.250 - 87, DR500S cc.500 - 92, RG50 cc.50 - 91, RG80, C cc.80 - 85-95, SP200 cc.200 - 86-88, SP250 cc.250 - 92, SP500 cc.500 - 92, TS125X cc.125 - 92, TS250X cc.250 - 94, TSS0W, XA, XK cc.50 - 91, TS80X cc.80 - 84-87

Tgb/Winking AS25 Bunny cc.50 - 96, AS50 X Bunny cc.50 - 94-95, AS50 X Kurier cc.50 - 95, AT50 Bunny cc.50 - 93, AT50 Bunny Gespann cc.50 - 93-94, Tutti i modelli / All models cc.150 - 00, Tutti i modelli / All models cc.125 - 00, Tutti i modelli / All models cc.90 - 00, Tutti i modelli / All models cc.50 - 00

Yamaha AEROX cc.50 - 98, Aerox R, Max cc.50, Beluga cc.50, Breeze cc.50, BW'S cc.50 - 97-08, BW's Bump, Spy cc.50 - 99, BW's Original cc.50 - 00-, CE50 RIVA JOG cc.50 - 86-87, CE50S Riva cc.50 - 86-87, CG50 cc.50 - 88-91, CR50, Z cc.50 - 89-95, CR90 cc.90 - 91, CT cc.50 - 90-95, CW50 Zuma cc.50 - 89-90, CW50 Zuma II cc.50 - 97-01, CW50, N, RS, RSP cc.50 - 09-, CW50, RS, RSX, BW's cc.50 - 91-97, CW50RSP NG cc.50 - 96-97, CW65 cc.65 - 94, CX50L, LN, N, RS, RSP cc.50 - 04-09, DT cc.50 - 03-08, EW Slider cc.50 - 00-02, EW50 cc.50 - 05, EW50N cc.50 - 05-, NEO'S cc.50 - 98, Original cc.50, SH50 Riva Razz cc.50 - 87-01, SH50, E, D, M Riva cc.50 - 87-94, Slider cc.50 - 00-, Spy cc.50, STS/SS cc.50 -, Why cc.50 - 99, YA ZA Jog Z cc.50 - 95-96, YEB0 Zesyt cc.80 - 94-96, YH50 cc.50 - 09-, YM50 Breeze cc.50 - 95-96, YN Neo's cc.50 - 07-08, YN50, M cc.50 - 09-, YQ50, L cc.50 - 05-, Zuma cc.50

cod. 0012240 Batteria YB5L-B

APPLICABILITÀ

Baotian BT50QT-9 4T Scout (Ruote 10) 50 2006-2008

Benelli K2 100 1999-2001

Garelli 125 TIGER XLE 86/-, GTA 125 1985-1987

Italjet Adly 50

Honda MTX R (JD05) 125 1983-1995, NS F 125 1988-1997, NS R/R II 125 1985-0099, ITALJET Adly 50,

Malaguti Centro SL / SL Kat. 50 1999-2000, Ciak 50 1999-2002, Ciak TD 50 2000-2001, F12 Phantom R AC 50 2007-2010, F12 Phantom R LC 50 2007-2008, F15 Firefox Twin Disk/Digit 50

Peugeot SV Geo 125 1991-1995

Piaggio Vespa ET2 IE 50 1997-0099, FL (V5N1) 50 1990-1990, FL2 Automatica (V5P21) 50 1990-1991, PK S (V5X2T) 50 1982-1985, PK SS (V5S1T) 50 1983-1985, PK S (VMXST) 125 1982-1985, PX TS (VNXST) 125 1985-1989,

Suzuki - 250 GT HUSTLER 73/77, - 250 TC SCRAMBLER 69, - 400 TS APACHE 89, - 600 DR R DJBEL / DAKAR - DR 86/90, - 600 SP 85/-, - 650 DR RS 90/91

Yamaha GIGGLE 4T 50 2008, YN F Neo's 4T 50 2009-2010, YN F Neo's 4T 50 2012-2015, - 125 TDR ITALIA (3XD/3SH) 89/93, - 125 TZR 79/81, - 125 TZR R/RR ITALIA (4DL) 91/95, - 125 TDR 89, - 550 XT 82/83, - 600 SRX (1XM/1XN) 86/91, TZR 125 1987-1992, TZR 250 1975-1977, XT (ZKF) 600 1987-1989, XT (43F/47N) 600 1983-1986

MINARELLI

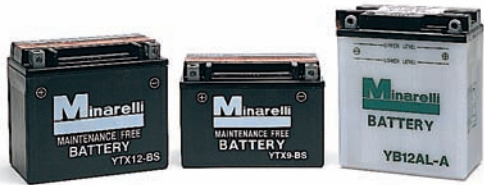

cod. **0012250**
Batteria YB9-B

APPLICABILITÀ

Aprilia	Scarabeo 4T / Rst 4T (TG000/TGA00/TGB00) 50 2003-2009, Scarabeo 4T 4V (TGE00) 50 2009-2011, Scarabeo 4T 4V Net (TGE00) 50 2010-2011, Sportcity One 4T (SBO0/SBC00) 50 2008-2011, Sportcity One 4T 4V 50 2011, Sportcity One Street 2T (SBA00) 50 2008-2011, SR R Factory Ditech (VFA00) 50 2005-2006, SR R Factory Hiper2 (VFD) 50 2005-2010, SR R Factory IE Purejet (VFB) 50 2005-2010, SR R Hiper2 (VFD) 50 2005-2010, Scarabeo 4T / Rst 4T / Net 4T (VAA00/VAC00) 100 2001-2010, Scarabeo 4T Net E3 (ZD4VAC/ZD4VAA) 100 2010-2011, AF1 Europa 125 1990-1991, AF1 Futura 125 1987-1992, AF1 Replica 125 1989-1990, AF1 Sintesi 125 1989-1991, AF1 Sport 125 1991, AF1 Sport Production 125 1991-1992, Classic 125 1995-1999, Pegaso/Kat 125 1992-2003, Red Rose 125 1987-1994, RS, RS Extrema, RS Pista 125 1992-2011, Sportcity One 125 2008-2011, Tuareg 125 1986-1990, Tuareg Rally 125 1989-1994, Tuareg Wind 125 1988, Tuono 125 2003-2004
Cagiva	Cruiser 125 1987, Cucciolo 125 1998, Freccia C10 R 125 1988, Freccia C12 R 125 1989, Freccia C9 125 1987, Mito 125 1990-2007, M 90 125 1989, Planet 125 1997-2002, Raptor 125 2003-2004, Supercity 125 1992, Tamanaco 125 1989
Derbi	Boulevard 4T 50 2009-2010, Boulevard / Boulevard E3 125 2003-2009, Boulevard 150 2003-2008, Boulevard 200 2004-2008
Garelli	GTA 125 1985-1987, Tiger XLE 125 1986

Gilera	Runner FL 50 2002-2007, Runner Purejet / Race 50 2002-2009, Runner Purejet ST 50 2008-2010, Runner SP Race 50 2005-2008, Runner SP Special Edition 50 2007, Runner SP ST 50 2008, Storm E2 50 2007-2008, Crono 125 1992, CX 125 1991, Fast Bike 125 1987-1989, Freestyle 125 1992, GFR 125 1986, KK 125 1986-1989, KZ 125 1986-1989, MX1 125 1989-1990, MXR 125 1990, R1/R1S 125 1989, RC Top Rally 125 1990, RRT Nebraska 125 1986-1988, RTX 125 1986-1987, Runner FX 125 1997-2002, Runner SP 125 1997-2002, Runner VX 4T 125 2002-2004, Runner VX SC / Race / ST 4T 125 2005-2007, RV 125 1984-1987, RX 125 1984-1986, RX Arizona 125 1986, SP 01 125 1990, SP 02 125 1990, Typhoon X 125 1995, XR1 125 1988, XR2 125 1988, Fast Bike 200 1985-1987, RTX 200 1985-1987, RX Arizona 200 1985-1987
Honda	CM C (MC06) 250 1982-1983, CMX C Rebel (MC13) 250 1985-1996
Italjet	Torpedo 4T 50 2001-2003, Formula 125 1997-1999, JetSet 125 2001-2003, Torpedo 4T Aria 125 1998-2000, Torpedo 4T LC 125 2000-2002, JetSet 150 2001-2003, Torpedo 150 2000-2002
Kawasaki	BN Eliminator 125 1998-2008, KTM, K4/LC 500
Malaguti	Ciak / Ciak Master / Rst E2 125 2000-2003, F18 Warrior 125 2000-2002, Madison R 125 1999-2003, Ciak / Ciak Master / Rst E2 150 2000-2003, F18 Warrior 150 2000-2002, Madison T 150 1999-2001, Madison R 180 2001-2002, Madison S 200 2002-2003, Madison S 250 1999-2003
Peugeot	Looxor 125 2002-2003, Looxor 150 2002-2003

Piaggio	Ape FL (TL6T) 50 1993, Ape FL2 (TL6T) 50 1994-1995, Ape FL3 Europa 50 1996-1999, Ape Mix RST 50 201, FLY 4T 50 2005-2008, Liberty 4T 50 2000-2003, Liberty Delivery 4T 50 2009-2010, Liberty MOC 2T 50 2009-2010, Liberty MOC 4T 50 2009-2010, Liberty PTT 4T 50 2009-2010, Liberty Rst 2T 50 2007-2008, Liberty Rst 4T 50 2004-2008, Liberty Sport 2T 50 2006-2008, Liberty Sport 4T 50 2004-2008, NRG Power DD 50 2007-2008, NRG Power DT 50 2007-2008, NRG Power Purejet 50 2004-2011, NRG Purejet 50 2010, NRG Purejet 50 2002-2004, Typhoon 2T / E2 50 2005-2009, Typhoon 2T E2 RT2 50 2010-2011, Zip 2T 50 2008-2009, FLY 4T 100 2005-2008, Beverly 125 2001-2003, Beverly Rst / Rst E3 125 2004-2006, FLY / FLY E3 125 2005-2008, Hexagon 125 1994-1997, Hexagon LX 125 1998-1999, Liberty 4T 125 2000-2002, Liberty 4T 125 1998-2000, Liberty Delivery 4T E3 125 2008, Liberty PPTT 125 2005-2006, Liberty Rst 4T 125 2004-2008, Sfera FL 125 1995-1997, Skipper LX 125 1998-1999, Skipper ST 125 2000, Typhoon 4T 125 2010-2011, X9 Evolution 125 2003-2006, FLY / FLY E3 150 2005-2008, Hexagon 150 1994-1997, Liberty 4T 150 2000-2003, Skipper LX 150 1998-1999, Skipper ST 150 2000, Vespa Vespa ET4 125 1996-1999, Vespa ET4 125 1999-2002, Vespa LX 125 2005-2006, Vespa PX E DT (VNX2T) 125 2000-2008, Vespa PX T5 (VNXST) 125 1985-1989, Vespa ET4 50 2000-2005, Vespa LX 4T 50 2005-2008, Vespa LX 4T 4V 50 2009-2010, Vespa LX 4T 4V Touring 50 2010-2011, Vespa LX FL 2T 50 2009-2010, Vespa LX Touring 2T 50 2010-2011, Vespa LXV 2T 50 2006-2008, Vespa LXV 4T 50 2005-2008, Vespa LXV Navy 2T 50 2008, Vespa S 2T 50 2007-2008, Vespa S 4T 4V 50 2008-2010, Vespa ET4 150 1999-2004, Vespa LX 150 2005-2006, Vespa PX E DT (VLX1T) 150 2000-2004, Vespa PX E DT (VST1T) 200 2000-2004
----------------	--

cod. **0012260**
Batteria YB10L-A2

APPLICABILITÀ

Gilera	350 Dakota E-Starter 0 - 2011, 350 Er E-Starter 0 - 2011, 500 Dakota E-Starter 0 - 2011
Kawasaki	250 Kz250 Csr, Ltd 1980 - 1983, 305 Kz250 Csr, Ltd 1981 - 1988, 650 Kz650 Sr, Ltd, Custom 1977 - 1980, 900 Kz900, Ltd 1976 - 1977, Suzuki, 250 Gnz250 1982 - 1988, 250 Gs250t 1980 - 1981, 400 Gs400 1977 - 1978, 425 Gs425, Gs425e, L 1979, 450 Gs450 1980 - 1982, 550 Gs550e, L, M, Tx 1977 - 1982, 650 Gs650e 1981 - 1982

Yamaha	250 Xv250 Route 66 1988 - 1990, 250 Xv250 Virago 1995 - 2003, 250 Xv250ycr V Star 250 2009 - 2012
---------------	---

cod. **0012310**
Batteria YT4L-BS

APPLICABILITÀ

Adly	Cat 2T 50 1997 -, Fox 2T 50 1998 - 2002, G-Shock 2T 50 1997 - 1998, Jet 2T 50 1997 - 1999, Jet E1 2T 50 1999 - 2003, Noble 2T 50 2006 -, Panther 2T 50 2002 - 2009, Rs Supersonic Atv 2T 50 2005 - 2007, Rt Road Tracer 2T 50 2002 -, Sf Silver Fox 2T 50 2006 -, Ss Supersonic 2T 50 2004 -, Tb Thunderbike 2T 50 Tutti, Cat 2T 100 1997 - 1998, Jet 2T 100 1999 - 2003, Noble 2T 100 Tutti, Panther 2T 100 2001 - 2006, Predator 2T 100 1997 - 2000, Predator 2 2T 100 2001 - 2003, Rt Road Tracer 2T 100 2002 -, Ss Supersonic 2T 100 2001 - 2006, Z1 100 Tutti
Aeon	Cobra 50 Tutti, Cobra 90 Tutti
Benzhou	Yy50qt 4T 50 2007 - 2008, Yy50qt / 6A 4T 50 2007 - 2008
Bombardier-Can Am	Ds Mini 50 2003 - 2006, Quest 50 2003 - 2006, Ds Mini 90 2003 - 2010, Quest 90 2003 - 2006
Cpi	Crab 50 2000, Hussar 50 2000, Popcorn 50 2000, Crab 100 Tutti
Daelim	Message 50 1999 - 2000, Tapo 50 1999 -, Delfino 100 2001 - 2003
E-Ton	Axl / Nxl / Txl Lightning / D 2T 50 1999 - 2001, Rxl Viper / M 2T 50 2002 - 2005, Txl Impuls 2T 50 Tutti, Dxl Sierra / U 2T 90 2000 - 2003
Gilera	Dna 50 2000 - 2007, Ice 50 2001 - 2005, Runnerpoggiali 50 2002, Stalker Dd / Dt 50 1997 - 2002, Typhoon E2 50 2001 - 2010, Typhoon Xr 50 2000

Honda	Gp Dio 50 1989 -, Pk Wallaroo 50 1990 - 2001, Sa Vision (Afz9) 50 1988 - 1994, Sc 01 / Sr 50 1992 -, Sgx Sky 50 1997 - 2001, Sp Dio Dt 50 1993 -, Sp Dio Tt 50 1993 -, Sr Dio 50 1992 -, Zx Dio 50 1993, Crm R 125 1990 - 1998
Husqvarna	Sm S 125 2000 - 2008, Wre 125 1998 - 2008
Hyosung	Plus 50 1995 -, Sd Sense E1 50 2000 - 2004, Sd Sense E2 50 2005, Sf 50 2005, Sf Fast 50 2000 - 2003, Supercab 50 191995 -
Keeway	Ec2 50 2006, Off Road 50 2007 - 2008, Kl-Shelung, Club 50 Tutti, Racer 50 Tutti
Ktm	Go / Gocrono 50 Tutti, Lc2 125 1996 - 1997, Sting 125 1997 - 1998, Exc 2T 250 2008 - 2012, Sxf 4T 250 2012, Exc 2T 300 2008 - 2012, Exc F 4T 350 2011 - 2012, Sxf 4T 350 2010 - 2012, Sxf 4T 450 2007, Sxf 4T 450 2011, Exc 4T 500 2012, Sxf 4T 505 2007 - 2008, Exc R 4T 530 2008 - 2010
Kymco	Bet & Win / Bet & Win E2 50 2002 - 2007, Cx 50 1993, Cx Super 50 1994 - 1997, Dj 50 1991 - 2000, Grand Dink 2T 50 2005 -, Heroism 50 1995 - 1997, K12 50 1995 - 2000, Kb 50 1995 - 2000, People S 2T 50 2005 - 2011, Sniper Dt / Dd 50 1993 - 1996, Vitality 2T 50 2004 - 2008, Yup 50 2002 -
Mbk	Forte 50 1994 - 1996, Match G 50 2002 -, New Sorriso 50 1995 - 1996, Nitro 100 2000 -, Ovetto 100 2000 - 2002
Pgo	Comet 2T 50 1992 - 2003, Galaxy 2T 50 1992 -

Piaggio	Free Delivery 50 2000 - 2001, Nrg Extreme Dd 50 1999 - 2001, Nrg Extreme Dt 50 1999 - 2001, Zip Catalyzed 50 2000 - 2002
Suzuki	Ah Address 50 1992 - 1995, Ap R / TR 7 50 1994 - 1997, Ay Katana Air / Lc 50 1997 - 1998, Ay Katana Lc 50 1998, Cc Tune 50 Tutti, Cp 50 1991 - 1994, Sepia 50 Tutti, Ux Zillion 50 1999 - 2003, Zz 50 1992 -, Dr S (Sf42a) 125 1982 - 1984, Is R 125 1989 - 1994, Dr S 250 1990 - 1992, Rgv Gamma 250 1991 - 1992, Dr S (Sk42a) L-P 350 1990 - 1993, Dr Se (Sk42a) R-W 350 1997 - 2001, Dr R 650 1992 - 1993
Sym	Dd 2T 50 2002, Dd E2 2T 50 2003 - 2007, Fiddle 50 1999 - 2005, Jet 50 1999 - 2002, Jungle 50 1999 - 2000, Mask 50 2000 - 2005, Maske 2 50 2000 - 2005, Red Devil 50 1999 -, Super Fancy 50 1998 - 2000
Tgb	101R 2T 50 2004 - 2009, 101S 2T 50 Tutti, 303 Laser 50 2004 - 2009, 303RS Laser 50 2004 - 2009, 303RS Laser 50 2004 - 2009, Akros 50 1979 - 1981, Delivery 2T 50 2004 - 2009, Ergon 50 1989, Hawk 50 Tutti, Laser RS 2T 50 Tutti
Vespa	Et2 50 1997 - 2005, Et2 le 50 1997 - 1999
Yamaha	Cs Jog R (5Rw / 5Rw13d43 / 3D4c / 4D4r) 50 2002 - 2010, Tzr R 50 2003 - 2008, Ya R Axis S / T 50 1995 - 1996, Yn Neo's 100 2000 - 2002, Yq Aero 100 2000

MINARELLI

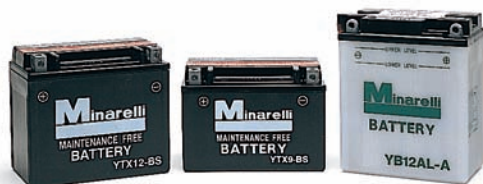

◀ cod. **0012320**
Batteria YTX12-BS

APPLICABILITÀ

Adly	Cross X Over 150 2007 - 2008, Cross X Road 150 2007 - 2008, Crusader 4T 150 2009, Interceptor 4T 150 2005 - 2008, Cross X Over 300 2007 - 2008, Cross X Road 300 2007 - 2008, Quad Crusader 300 2009, S 320 2007, S Hurricane 500 2008	Honda	Trx Fourtrax 200 1990 - 1997, Cn Helix-Spazio (Mf02) 250 1995 - 1999, Fes Foresight (Mf04-Mf05) 250 1997 - 2005, Trx-Trx Es Recon 250 1997 - 2007, Trx Te Fourtrax Recon (Te2-Tea) 250 2002 - 2010, Trx Tm Fourtrax Recon (Tm2-Tma) 250 2002 - 2010, Trx X Fourtrax 250 1986 - 1988, Nr (Rc40) 750 1993, Vf C Shadow-Magna Cd C2-(Rc43) 750 1994 - 1998, Vfr F (Rc24-Rc24ii-Rc36-Rc36ii) 750 1990 - 1997, Pc Pacific Coast (Rc34) 800 1989 - 1997, Vfr Fi (Rc46) 800 1998 - 2000, Cb F Big One Superfour PR,S,T (Sc30) 1000 1993 - 1996, Vtr F Fire Storm (Sc36) 1000 1997 - 2000, Cb Sf Xeleven X11 (Sc42) 1100 1999 - 2001, Cbr Xx Superblackbird (Sc35) 1100 1996 - 2000, Kawasaki, Er5 (Er500 A1-A4-C1-C5) 500 1997 - 2002, Kle (Le500a) 500 1991 - 2007, Zx6r Ninja (Zx600F1-F2-F3-G1-G2-J1p-J2p) 600 1996 - 2002, Zzr Ninja (Zx600d-E) 600 1993 - 2001, Er6 F (Ex650a6f,A7f) 650 2006 - 2011, Er6 N 650 2006 - 2011, Kle Versys 650 2007 - 2011, Zr Zephyr (Zr750C-D) 750 1991 - 1999, Zr7-Zr7s (Zr750F) 750 1999 - 2003, Zx7r Ninja (Zx750P1-P2-P3-P4-P5-P6) 750 1996 - 2003, Zxr (Zx750H1-L2-L3) 750 1993 - 1995, W (Ej800) 800 2011, Vn Vulcan Classic (Vn900b) 900 2006 - 2011, Vn Vulcan Custom (Vn900c) 900 2007 - 2011, Zx9r Ninja (Zx900b-C-E) 900 1994 - 1997	Piaggio	Beverly 125 2001 - 2003, Beverly Rst-Rst E3 125 2007 - 2008, Beverly Rst E3 4T-4V 125 2010 - 2011, Hexagon Lx4 125 1998 - 1999, Liberty Moc 4T 125 2009 - 2010, Superhexagon Gtx 11" 125 2000 - 2001, Superhexagon Gtx 12" 125 2001 - 2002, X Evo le E3 125 2009 - 2010, Hexagon Lxt 180 1998 - 1999, Superhexagon Gtx 180 2000 - 2001, Beverly 200 2001 - 2003, Liberty Rst-Liberty Rst E3 200 2006 - 2008, Hexagon Gt 250 1998 - 1999, Superhexagon Gtx 250 2000, X9 250 2000 - 2003, Carnaby Cruiser (Zapm60400) 300 2009 - 2011, X7 Evo E3 (Zapm62201) 300 2009 - 2010, Beverly le 4T-4V E3 350 2011 - 2012, Vespa Gts E3 125 2007 - 2010, Gtv 125 2007 - 2008, Gtv Navy E3 125 2008 - 2009, Lx E3 125 2006 - 2009, Lx Fi 125 2009 - 2010, Lx le E3 125 2009 - 2010, Lx Touring le 125 2010 - 2011, Lxv le E3 125 2010, S le 125 2009 - 2011
Aeon	Cobra 220 2004 - 2007, Crossland Lc 4T 300	Kymco	Bet & Win 250 2000 - 2007, Dink Sport 250 2001, Grand Dink 250 2001 - 2009, Kxr 250 2004, Mxu 250 2005 - 2006, People 250 2003 - 2005, People S 250 2006 - 2008, People S le 250 2007 - 2009, Xciting 250 2004 - 2005, Xciting I 250 2006 - 2008, Yup 250 2003 - 2005, Maxxer-Mongoose 300 2005 - 2006, Mxu-Mxu R 300 2005 - 2009, People S I 300 2008 - 2010, Xciting I 300 2008 - 2011, Xciting I R 300 2008 - 2011, Xciting R 500 2005 - 2008	Polaris	Phoenix 200 2005 - 2010, Sawtooth 200 2006 - 2007
Aprilia	Scarabeo Light 4T (Rb000-Rba00) 125 2007 - 2008, Scarabeo Light le 4T (Rbg00-Rbh00) 125 2009 - 2011, Scarabeo Net le 4T (Rbg00) 125 2010 - 2011, Sportcity Cube 125 2008 - 2011, Scarabeo Light 4T 200 2007 - 2009, Scarabeo Light le 4T 200 2009 - 2010, Sportcity Cube 200 2008 - 2010, Sportcity Cube 250 2008 - 2010, Scarabeo Light -Special 300 2009 - 2010, Sportcity Cube 300 2008 - 2011, Sr Max 300 2011, Atlantic Sprint 400 2005 - 2008, Scarabeo Light 400 2006 - 2008, Atlantic Sprint 500 2005 - 2008, Scarabeo le Light 500 2006 - 2010, Pegaso Factory 660 2007 - 2009, Pegaso Strada 660 2005 - 2009, Pegaso Trail 660 2005 - 2008, Rst Futura 1000 2001 - 2004, Rsv-Rsv R 1000 2001 - 2003, Rsv 4 R 1000 2009 - 2011, Rsv 4 R Factory 1000 2009 - 2011, Rsv R-Factory 1000 2003 - 2008, Rsv Sp 1000 1999 - 2000, Tuono Fighter 1000 2002 - 2005, Tuono R-Racing-Factory 1000 2003 - 2009, Tuono V4 R 1000 2011, Dvx 250 2006 - 2009	Malaguti	Madison 3 125 2009, Madison 3 250 2006 - 2009, Password-Password E3 250 2005 - 2008, Phantom Max 250 2004	Suzuki	Lt E Quadrunner 230 1988 - 1993, Lt F Ozark (K2-K9-LO) 250 2002 - 2010, Lt F Quadrunner 4X4 (Fx-Fy-Fk1-Fk2) 250 1999 - 2002, Di V Strom 650 2004 - 2011, Di V Strom Abs 650 2007 - 2011, Dr Re 650 1994 - 1995, Dr Se 650 1994 - 1995, Sv 650 2003 - 2008, Sv S 650 2003 - 2008, Gsx R 750 92 - 1995, Vi Intruder C800 800 2006 - 2011, Vi Intruder Volusia 800 1999 - 2005, Vz Intruder M800 800 2005 - 2011, Gsx R 1000 2001 - 2004, TI R 1000 1996 - 2002, TI S 1000 1996 - 2002, Gsx R 1100 1993 - 1996, Gsf Bandit 1200 1995 - 2005, Gsf Bandit S 1200 2001 - 2005, Gsx Inazuma 1200 1999 - 2001
Benelli	Velvet-Velvet Touring 250 1999 - 2003, Bombardier-Can Am, Ds 250 2006 - 2009	Peugeot	Sv 250 2001 - 2002	Sym	Joy Max Gts 250 2006 - 2007, Joy Max Gts E3 le 250 2007 - 2008, Quad Lander 250 2006 - 2007, Citycom-Ef 300 2007 - 2010, Joy Max Evo 300 2009 - 2010, Quad Lander S 300 2007 - 2008
Daelim	Ns Iii Otello Fi 125 2007, S2 Freewing 125 2006 - 2008, S2 Freewing Fi 125 2009, Vj Roadwin 125 2004, Vj Roadwin Fi 125 2008, VI Daystar Fi 125 2008, S2 Sq Freewing 250 2006, Derbi, Rambla 125 2008 - 2009, Rambla 250 2008 - 2009, E-Ton, Vxl Vector St 250 2010			Triumph	Speed Four (T82001 - 19811-T806lb) 600 2003 - 2005, Tt (T800) 600 2000 - 2004, America 800 2003 - 2006, Bonneville (908Md) 800 2001 - 2006, Bonneville America (908M) 800 2002, Speedmaster (908MI) 800 2003 - 2004, America 900 2007 - 2010, Bonneville 900 2007 - 2010, Scrambler 900 2006 - 2010, Speedmaster (909MI) 900 2003 - 2010, Thruxton (T914) 900 2004 - 2010, Speed Triple S 1050 2005 - 2010, Sprint St 1050 2005 - 2010, Tiger 1050 2006 - 2010
Gilera	Nexus 125 2007 - 2008, Runner Vx 4T 125 2000 - 2001, Runner Vx Sc-Race-St 4T 125 2008 - 2010, Runner Vxr 4T 180 2000 - 2001, Runner Vxr Race-St 4T E3 200 2008 - 2010, Nexus le E3 300 2009 - 2010			Yamaha	Fzr R 600 1994 - 1995, Yzf Thundercat (4Tv-4Wd) 600 1996 - 2003, Xvs Drag Star (4Xr-4Vr) 650 1997 - 2002, Xvs Drag Star Classic (Vm022-Vm025) 650 1998 - 2002, Tdm 850 1991 - 1995

MINARELLI

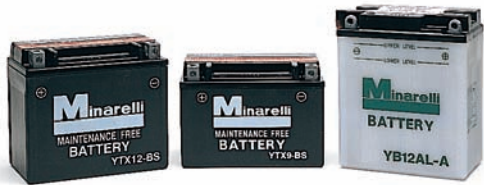

◀ **cod. 0012330**
Batteria YTX9-BS

APPLICABILITÀ

Arctic Cat 150 cc.150 10, ARCTIC CAT DVX400 cc.400 tutti
Atk ATK Tutti i modelli (Electric-Start) cc. 91-95
Benelli Adiva 150 cc.150 00-, Velvet cc.125 99-08, Velvet cc.150 10-, Velvet cc.250 99-04
Betamotor Eikon cc.150 00-02, EURO cc.300 JONATHAN cc.300
Cagiva Raptor (all models) cc.650 01, V-Raptor cc.650 01-06
Ccm CCM Tutti i modelli (Electric-Start) cc.600 96-01
Cannondale All Models cc.60 01-03, Blaze, C bal, Moto cc.440 02-03, FX400 cc.400 01, Glamis, Speed cc.440 02-03
Dazon Raider-Classic (Kart) cc.250, Raider-Classic (Kart) cc.150 04, Raider-Max (Kart) cc.250, Raider-Max (Kart) cc.150 04, Scorpion cc.125 04
Derbi Boulevard cc.150 02-07, Boulevard cc.200 05, GP1 cc.250 06-08, Rambla cc.250 08, DXR Quad cc.200 04-05, DXR Quad cc.250 04-05
E-Ton Beamer 150 cc.150 -11, Beamer R4-150 cc.150 10, Matrix R4-150 cc.150 -11, CXL150 Yukon II cc.150 00-01, Viper 150R cc.150 10, YRL150 Yukon cc.150 02-03
Garelli King cc.150 07-08, Xo cc.125 10-
Hm HM TRX EX Sportrax 5-6-7 cc.400 05-07
Honda CB400F CB-1 cc.400 89-90, CB500, S cc.500 94-96, CBR400RRR cc.400 86-89, CBR500F cc.500 87-89, CBR600 cc.600 87-00, CBR600 F, Fill, Fill, SE cc.600 95-99, CBR600F cc.600 87-88, CBR600F/SP cc.600 87-00, CBR900RR FireBlade cc.900 92-99, CBX250, RS-YA cc.250 85-87, CD250 U cc.250 85-89, CH125 Spacy cc.125 88-95, CH150 Elite cc.150 87, CHA125T cc.125 96, CR750 45 cc.750 -, Deauville cc.650 -, FES150 cc.150 99-02, FX650 cc.650 -99, NT650 Hawk GT, NX650 cc.650 88-91, NT650V cc.650 -11, NTV600 cc.600 88-92, NTV650 Revere cc.650 88-97, NV400C cc.400 95, NV600C cc.600 89-94, NX500 cc.500 88-95, NX650 cc.650 88-89, NX650 Dominator cc.650 88-97, RC 45 cc.750, RVF750R cc.750 94-95, Shadow 600 cc.600 -, SLR650 cc.650 -11, TR200 cc.200 86, TR200 Fat Cat cc.200 86, VF750C Magna cc.750 93-94, VFR750R cc.750 88-90, VFR750R (RC30) cc.750 90, VFR750R (RC45) cc.750 94, VT600 C Shadow cc.600 88-99, VT600 C, CD Shadow Deluxe, VXL cc.600 88-03, VT600C cc.600 88-97, XR650L cc.650 93-10, TRX125 Fourtrax cc.125 87-88, TRX250 EX, Sportrax cc.250 01-03, TRX250 EX, TE, TM cc.250 01-12, TRX250X, EX Sportrax cc.250 01-10, TRX300EX Fourtrax cc.300 88-00, TRX300X, EX cc.300 93-12, TRX400EX, FourTrax, Sportrax cc.400 99-10, TRX700XX cc.700 08-10

Husaberg Tutti i modelli (Electric-Start) cc. 97-00, Tutti i modelli (Electric-Start) cc. 01-02
Hyosung GV250 cc.250 09-10, NS3-250 cc.250 09-10, TE cc.450 07, TE450S cc.450 10
Italjet ITALJET Juppiter cc.250 01-03
Kawasaki Estrella - BJ250 A2-A3 C2-C3 cc.250 92-, KLX650 (LX650C) cc.650 93-97, KLX650C, R cc.650 93-96, KZ750-L Ninja K cc.750 93, Versys 1000 cc.1050 12-, Z1000 cc.1000 03-10, Z1000 SX cc.1000 11-, Z750 cc.750 04-08, Z750 (EU) cc.750 09-10, Z750R cc.750 12, ZR400D Xanthus cc.400 92-, ZR750 (Z750S) cc.750 05-06, ZX-, II (ZR400E, F, D) cc.400 95-, ZX-6R cc.600 12, ZX-6R Ninja cc.600 98-10, ZX-7R-7RR Ninja cc.750 91-96, ZX-7RR Ninja cc.750 96-97, ZX-9R (ZX900C, D) Ninja cc.900 98-99, ZX-9R (ZX900E, F) Ninja cc.900 00-03, ZX600-G, J ZX-6R cc.600 98-08, ZX600-K, M, N ZX-6RR cc.600 03-06, ZX636-B, C Ninja ZX-6R cc.636 02-06, ZX6R-ZR cc.600 05, ZX750 Ninja ZX, 7RR cc.750 91-97, ZX750-L ZX-7 cc.750 93-94, ZX900-C Ninja (ZX-9R) cc.900 98-99, ZX900-E, F Ninja (ZX-9R) cc.900 00-03, ZXR400, R (ZX400M, L) cc.400 91-, ZXR750R (ZX750K, M) cc.750 91-, ZZR600 cc.600 05-09, ZZR600 cc.600 98-02, KSF400-A (KFX400) cc.400 03-06
Ktm Adventure cc.620 96-98, Adventure R cc.625 00-, Adventurer cc.640 99-02, Adventurer, Duke, RXC LC4 Super Moto cc.640 99-02, Duke cc.620 96-98, Duke E cc.620 96-98, Duke II cc.640 99-02, Duke, E cc.640 96-97, LC4 cc.400 98, LC4 Supercomp. cc.620 96-98, LC4-E cc.400 97, LC4-E, LC4 Supermotard cc.640 99-02, LS-E cc.400 97, LS-E cc.620 97, RXC LC4 cc.400 96-01, Supercromo cc.625 98
Kymco Agility cc.180 10-, B & W 125 cc.125 99, B&W 150 cc.150, Calypso 125 cc.125 99, Dink cc.150-, Dink cc.200 04, Dink II cc.125 -, Dink LX cc.125 97, Dink LX cc.150 97, EGO 150 cc.150 -, G5 125 cc.125 -, G5 125 Fi cc.125 11-, G5 150 cc.150 -, G5 150 Fi cc.150 -, Grand Dink cc.125, Grand Dink cc.150, Heroism cc.125 95-96, Heroism cc.150 96, Jockey 125 Fi cc.125 -, Movie cc.150 06-07, Movie 125 cc.125 99, Racing cc.180 -, Racing 125 cc.125 -, Racing 150 cc.150 -, Racing 150 Fi cc.150 -, Spacer cc.125 99, Spacer cc.150 99, V1 150 Fi cc.150 11-, Venox cc.250, Vivio cc.125, Vivio cc.150, MXER cc.125 02-03, MXER cc.150 04, MXU cc.150 05-06, MXU SR cc.50 06-07
Laverda Phoenix cc.125, Phoenix cc.150, Phoenix cc.200, Qusar 125-150 cc.125 02-04, Qusar 50-100 cc.50 02-04
Malaguti Centro cc.125 08, Centro cc.160 08, Ciak Master cc.125 04-08, Ciak Master cc.150, Ciak Master cc.180 06
Mbk Kilibre cc.250 03, Kilibre cc.300 03

Mv Agusta MV AGUSTA F4,SERIE Oro cc.750 01-
Peugeot PEUGEOT Looxor cc.125 02-03, Looxor cc.150 02-03
Piaggio Sfera RST cc.125 -, ST4 Leader cc.125 00-, Typhoon cc.150 -, Zip 4T cc.50 00-, Zip 4T cc.125 00-, Zip cat. 2T cc.50 00-
Polaris Outlaw 450 cc.450 07-10, Outlaw 525 cc.525 08-10, Predator, Outlaw cc.500 03-06
Suzuki AN Burgman cc.125, AN Burgman cc.150 03-, AN250 Burgman cc.250 00-02, AN400 Burgman cc.400 99-02, AN400 Burgman cc.400 03-10, DR650SE (Canada) cc.650 96-97, DR650SE, SEU cc.650 98-10, DR650SEE, SEU cc.650 91-04, GS400, E cc.400 91, GS400X cc.400 91-95, GSF Bandit cc.400 91-93, GSF 5 Bandit cc.650 05-08, GSF400 M cc.400 -, GSF600, S, SU, U, Uil BANDIT cc.600 02-, GSF650/U cc.650 -, GSR400 cc.400 -, GSR600 cc.600 -03, GSX 750WR cc.750 94-95, GSX F cc.600 98-06, GSX F cc.650 08, GSX F cc.750 01-06, GSX K6-K8 cc.600 06-08, GSX W cc.750 98-01, GSX-R 600 V, W cc.600 02-, GSX-R400R, RF cc.400 91-95, GSX-R600 cc.600 11-, GSX-R600 cc.600 97-10, GSX-R600W cc.600 92-93, GSX-R750 cc.750 96-99, GSX-R750, W cc.750 94-96, GSX400 cc.400 -, GSX600F Katana cc.600 98-06, GSX650/F cc.650 -, GSX750 cc.750 99-, GSX750, F cc.750 98-99, GSX750F Katana cc.750 98-06, Inazuma 250 cc.250 12, RF RR cc.900, RF600R, S cc.600 93-96, RF900R, S, ZS cc.900 94-97, SV400S cc.400 02-, UH Burgman cc.125 02-08, UH Burgman K7 cc.200 07-08, UX Sixteen K2-K6 cc.150 02-06, VS600 GLS cc.600 -, XF650 Freewind cc.650 97-, XF650 Freewind cc.650 02-, LT-Z Quadsport K4-K8 cc.400 03-10
Sym Euro MX cc.150 02-04, Fiddle cc.125 -10, HD cc.125 -10, HD cc.200 03-10, Joyride cc.125 01-07, Joyride cc.150 01-02, Joyrider cc.200 03-08, Shark cc.125 99-02, Shark cc.150 00-01, Super Duke cc.150 99-02, VS cc.125 06, VS cc.150 07, VS Euro3 cc.125 07-08, VS Euro3 cc.150 07-08
Triumph Daytona 600/650 Speed Four cc.600 03-05, Daytona 675 R cc.675 11-, Street Triple, R cc.675 09-10
Yamaha FZR400RR, RRSP cc.400 92-, FZR750 cc.750 91-, KJR400R cc.400 04-, SZR660 cc.660 96-, VP X City cc.250 07-08, VP X-City cc.125 08, VP125, R cc.125 09-, VP250 cc.250 07-, VP300 cc.300 04-, WP600SD SECA II cc.600 92-94, XC Versity cc.300 03-06, XJ600N cc.600 94-, XJ600S Diversion cc.600 92-, XJ600S SECA II cc.600 92-98, XTS00E cc.500 93-, XT600E, EH, EN cc.600 90-02, XT600E, F, G cc.600 90-95, XTZ660 Tenere cc.660 92-96, YP R X-Max cc.250 05-08, YP R X-Max cc.125 06-08, YP125, E cc.125 09-, YP250R, YP250R cc.250 07-, YP250R cc.250 -, YP250RA cc.250 -

◀ **cod. 0012340**
Batteria YB12AL-A

APPLICABILITÀ

Aprilia 125 Atlantic/Atlantic E3 03/09, 125 Leonardo 96/98, 125 Leonardo St 99/04, 125 Scarabeo 4T Rotax 99/02, 125 Scarabeo Gt 4T 03/07, 150 Leonardo 96/98, 150 Leonardo St 99/04, 150 Scarabeo 4T 99/02, 200 Atlantic 03/08, 200 Scarabeo 4T Rotax 99/02, 200 Scarabeo Gt 4T 03/07, 250 Atlantic 04/06, 250 Atlantic le/Atlantic le E3 06/09, 250 Leonardo/Leonardo St 99/01, 250 Scarabeo/Scarabeo Gt 04/06, 250 Scarabeo Light le/ E3 06/10, 300 Leonardo St 04/05, 650 Pegaso/Cube/le 90/04
Bmw 650 F/St Strada/Funduro 93/08, 650 F Cs Scarver (K14) 02/05, 650 F Gs/Dakar (K78) 01/07, 650 F G Gs (R13) 08/10

Honda 450 Cb N (Pc14) 83/92, 650 Cb Sc Nighthawk (Rc08) 82/83, 1100 Cb F (Sc11) 81/83, 1100 Cb R (Sc05/Sc08) 81/83
Malaguti 250 Madison Rs 04/05, 400 Madison K 02/04
Peugeot 125 Elystar 05/06, 125 Geopolis 4T, 125 Geopolis 4T, 125 Satelis 06/-, 150 Elystar 05/06, 250 Geopolis 06/08, 250 Satelis 06/08, 400 Geopolis 06/08, 400 Satelis 06/08, 500 Geopolis 06/08, 500 Satelis 06/08

MINARELLI

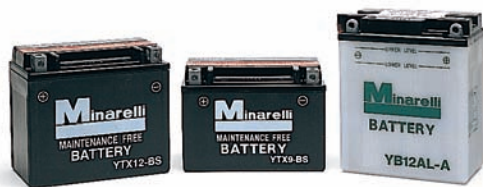

◀ **cod. 0012350**
Batteria YTX7A-BS

APPLICABILITÀ

Aprilia Enduro cc.450, Enduro cc.550, Motard cc.450, Motard cc.550, MXV cc.450, RXV 450 CND cc.450, RXV 450 USA cc.450, RXV 550 CND cc.550, RXV 550 USA cc.550, RXV450 cc.450 - 2010, RXV550 cc.550 - 2010, SVX450 cc.450 - 2010, SVX550 cc.550 - 2010, SVX 450 CND cc.450, SVX 550 CND cc.550

Daelim MS125, Othello 125 cc.125 -, NS125 cc.125 - 1997

Dazon DAZON Sicilian cc.125 - 2004

E-Ton Sport 150 cc.150 - 2011, Sport 50 cc.50 - 2011

Honda RVF400 (NC35) cc.400, TR200 cc.200 - 1987, TR200 Fat Cat cc.200 - 1987, VFR400R III cc.400 - 1990-1991, XLR125R cc.125 - 1998

Hyosung GT125 Comet cc.125 - 2009-2010, XRX cc.125

Italjet Millenium cc.125 - 2000-2003, Millenium cc.150 - 2000-2002

Kasea RX125 cc.125 -, KS, KU Models cc.65 - Tutti, KS, KU Models cc.90 - Tutti, KS, KU Models, Adventure buggy cc.125 - Tutti, Skyhawk150, Adventure Buggy cc.150 - Tutti, Skyhawk170 cc.170 - Tutti, Skyhawk250 cc.250 - Tutti

Kawasaki EX250 Ninja 250R cc.250 - 2012, EX250, Ninja 250R cc.250 - 2008-2010

Kymco Agility cc.50 - 2009-2010, Agility cc.125 - 2006-2008, Agility RS Naked cc.50 - 2010, Caro 100 cc.100, Cherry 100 Fi cc.100 - 2011, Easy 100 Fi cc.100, GP 125 cc.125, Herself cc.125, Hipster 150 cc.150, Jockey 125 cc.125, JR 100 cc.100, JR 100 Fi cc.100, Kiwi 100 cc.100, Many 100 Fi cc.100 - 2011, Many 110 cc.110 - 2011, Many 50 Fi cc.50 - 2011, People cc.200 - 2005, People 125 cc.125 - 2000-2010, People 4T cc.50 - 2006-2008, People S cc.125, People S, Super 8 cc.150 - 2009-2010, People, S cc.200 - 2011, So Easy Fi cc.100, Sonner 100 cc.100, Super 8 cc.50 - 2007, V1 125 Fi cc.125 - 2011, VJR cc.110 - 2011, VJR 100 Fi cc.100 - 2011, VJR 50 Fi cc.50 - 2011, VP 125 cc.125, X MODE cc.100 - 2011

Mbk Flame cc.125 - 1995-1997, Flame-R cc.125 - 1998, Ver-tex cc.150 -, XC Flame/Flame R cc.125

Peugeot Tweet 125 cc.125 - 2010, Tweet 50 cc.50 - 2010

Sanyang Attila cc.150 - 1999, Duke cc.125 - 1995-1996, Super Duke, Duke cc.150 - 1999

Suzuki AN cc.125 -, AN-Y cc.150 - 1996-2000, AN125(Vecstar) cc.125 - 1995-1996, AN125(Vecstar) cc.125 - 2002, AN150 Burgman cc.150 - 1998, AN150 Burgman cc.150 - 2002, AN250 Burgman cc.250 - 1999, AN250 Sky Wave cc.250 - 1998, Epicuro cc.125, GSF250 cc.250 - 1995, GSX250F, S cc.250 - 1991-1995, GSX400F5 Inazuma cc.400 - 2002, HJ125T-9 cc.125, UC Epicuro X-K1 cc.150 - 1999-2001, UE cc.125 -, UE CT K1 cc.150 - 2001, UX Sixteen cc.125 - 2001, VZ400 cc.400 - 2002, LT-R Quadracer cc.450 - 2006-2010, LT-Z90 QuadSport cc.90 - 2007-2010

Sym Attila cc.125 - 1999-2000, Attila cc.150 - 2000-2001, Cinderella cc.100 - 1999-2001, Fiddle cc.50 - 2010, Fiddle cc.125 - 2010, Fiddle II cc.125 - 2008-2010, Fiddle II cc.50 - 2010, Megalo cc.125 - 2006-2007, MIO 50 cc.50 - 2010, New Duke cc.125 - 2000-2001, Super Duke cc.125 - 1999-2002, Symphony cc.50 - 2011, Symply cc.50 - 2007-2010, Symply cc.125 - 2007-2010

Yamaha NXC Cygnus X cc.125 - 2007-2010, NXC125 cc.125 - 2007-2010, SRV250, G cc.250 - 2007-2010, Vity cc.125 - 2007-2010, XC125 Cygnus-X cc.125 - 2007-2010, XC125E cc.125 - 2007-2010, XC125R, T, TR Cygnus cc.125 - 2007-2010, XC125TRB cc.125 - 2007-2010, YJ125T VINO 125 cc.125 - 2007-2010, Zuma 125 cc.125 - 2007-2010

◀ **cod. 0012360**
Batteria YTR4A-BS

APPLICABILITÀ

Honda 50 Sfx (Af37) 96, 50 Sh Fifty (Af40) 96/01, 50 S J Bali (Af32) 96, 50 Srx 95/-, 50 X8s/X8rx 99/00, 50 Zx Dio 94/-

◀ **cod. 0012380**
Batteria YTX5L-BS

APPLICABILITÀ

Adly Adly Rs Supersonic Atv 50 2006 - 2008

Aprilia Rs 50 2006 - 2011, Rs4 50 2011, Scarabeo Ditech (Sca00) 50 2001 - 2006, Sr Ditech (Rib1/Rld1) 50 2000 - 2003, Sr Street Purejet (Te000) 50 2003 - 2010, Scarabeo 2T 100 2000 - 2001

Baotian Bt49qt-7A2/A3 4T R12 50 Tutti, Bt49qt-7B2/B3 4T R12 50 Tutti, Bt49qt-9D1/D2 4T R10 50 Tutti, Bt50qt-11 4T (Gy6139qmb) [139Qmb] 50 Tutti, Bt50qt-11 4T Tommy 50 Tutti, Bt50qt-12 4T Rebel 50 Tutti, Bt50qt-12 4T Tan-co 50 Tutti, Bt50qt-7 4T 50 2007, Bt50qt-7 4T (Chase) 50 Tutti

Betamotor Alp 4T 125 2008 - 2010, Rr 4T 125 2006 - 2010, Rr 4T Sm 125 2006 - 2010, Urban 4T 125 2008 - 2010, Alp 4T 200 2008 - 2010, Urban 4T 200 2008 - 2009, Rr En (Mot.Ktm) 250 2005 - 2007, Rr Sm (Mot.Ktm) 250 2005 - 2007, Rr En (Mot.Ktm) 400 2005 - 2010, Rr Sm (Mot.Ktm) 400 2005 - 2010, Rr En (Mot.Ktm) 450 2005 - 2010, Rr Sm (Mot.Ktm) 450 2005 - 2010, Rr En (Mot.Ktm) 525 2005 - 2010, Rr Sm (Mot.Ktm) 525 2005 - 2010

Cagiva Cagiva Passing 125 1994

Cpi Aragon Gp/Paddock/Club 50 2007 - 2008, Bingo FI 50 2002, Formula R Ac 50 2008, Hussar/SI/Fl/Euro 2 50 2001 - 2005, Oliver/City/Sport 50 2003 - 2007, Popcorn/SI/Fl/Euro 2 50 2001 - 2004, Tennessee 50 2001, Aragongp/Paddock/Club 125 2007 - 2008

Derbi Gprnude/Sport/Tuning 50 2004 - 2009, Gpr/Replica/Racing/E2 50 2004 - 2009, Senda R Drd Pro E2 50 2005 - 2011, Senda Sm Drd Pro E2 50 2005 - 2009, Atlantis 4T 100 2004 - 2005, Gpr 125 2004 - 2006, Gpr Nude 125 2004 - 2006

E-Ton Beamer 2T (Pn2) 50 2000 - 2004, Beamer li 2T (Pn2b) 50 2005 - 2006, Beamer lii 2T (Pn2d) 50 2007 - 2009, Beamer Matrix 2T (Pn2c) 50 2005 - 2006, Beamer Matrix li 2T (Pn2e) 50 2007 - 2008, Axl Lightning 2T 90 Tutti, Axl/Nxl/Txl Thunder/D 2T 90 1999 - 2001, Rxl Viper/R 2T 90 2002 - 2006, Txl Impuls 2T 90 Tutti

Honda Srx Shadow (Af20e) 50 1997, Srx Shadow (Hf09) 90 1998, Scv Lead (Jf11) 100 2003 - 2007, Sh 100 1996 - 1999, S J Bali (Hf07) 100 1996 - 1999, Clr City Fly (Jd18) 125 1999, Nsr F 125 1990 - 1992, Nsr R/R li/Raiden 125 1990, Ftr 223 2000 - 2004, Crf F (Me03) 230 2003 - 2010, Crf F Easy Motard (Me03) 230 2003 - 2006, Sl 230 1997 - 2004, Cre X (Hm Italia) 250 2004 - 2006, Cre X le (Hm Italia) 250 2007 - 2009, Crf X (Me11) 250 2004 - 2012, Crm X le (Hm Italia) 250 2007 - 2008, Cre X le (Hm Italia) 290 2007 - 2008, Crm X le (Hm Italia) 290 2007 - 2008, Cre F X (Hm Italia) 300 2009 - 2010, Nsr (Nc19v) 400 1985

Husaberg Fs E 650 2001 - 2003

Hyosung Sb M 50 2007 - 2008, Sf B Raging 50 2001, Sf Prima 50 2000, Te 50 2005, Te 90 2005, Ez M 100 2007 - 2008, Te 100 2005

Keeway F-Act 50 2007 - 2008, F-Act Raging 50 2008, Focus 50 2006, Hurricane 50 2007 - 2008, Matrix 50 2006 - 2008, Ry8/Sp 50 2006 - 2008

Ktm Exc F 4T 250 2007 - 2012, Exc Racing 4T 250 2004 - 2006, Exc 4T 400 2004 - 2008, Exc R 4T 400 2009 - 2011, Exc 4T 450 2004 - 2007, Exc R 4T 450 2008 - 2012, Mxc 4T Racing 450 2000, Smr 4T Supermoto 450 2010, Sxf 4T 450 2007 - 2010, Sxf Atv 450 2009 - 2010, Xc Sport Atv 450 2008 - 2010, Sxf 4T 505 2007 - 2008, Sxf Atv 505 2009 - 2010, Exc 4T 520 2000 - 2002, Exc 4T 525 2004 - 2007, Xc Sport Atv 525 2008 - 2009, Exc R 4T 530 2008 - 2010

Kymco Agility 4T R10 50 2005 - 2011, Agility 4T R12 50 2007 - 2011, Dink 4T 50 2007 - 2011, Dink Air 2T 50 1999 - 2002, Dink Classic Air 2T Euro 2 50 2003 - 2007, Dink Lc 50 1999 - 2002, Fever Zx-E2 50 2000 - 2005, Filly 4T Tt 50 1998 - 2000, Kxr 50 2004, Maxxer/Mongoose 50 2005 - 2010, Mxer/Euro 2 50 2002 - 2004, People 2T 50 1999 - 2004, People 2T E2 50 2003 - 2011, Sento-New Sento 4T 50 2008 - 2009, Super 9-Super 9 Sport 50 2000 - 2007, Top Boy Off Road 50 1997 - 2000, Top Boy On Road 50 1997 - 2000, Vitality 4T 50 2004 - 2008

Malaguti F12 Phantom 100 1999

Mbk Booster 100 1999

Peugeot Elyseo 100 2000 - 2001, Looxor 100 2001, Speedfight 100 1997 - 2000, Trekker 100 1998, Vivacity 100 1999 - 2000, X Fight 100 2000 - 2003

Suzuki Lt Z QuadSport 50 2006 - 2007, Lt QuadSport 80 2002 - 2006, Ah Address 100 1995 - 1996, Ug Hokuto 110 2000 - 2002, Rg Gamma 125 1986 - 1990, Rg Gamma 500 1975 - 1977

Sym Jet 100 1999 - 2000

Yamaha Xf Giggie 50 2008, Bw's 100 1999, Tdr R (4Gw/4Gx) 125 1993 - 2003, Wr F 250 2003 - 2007

MINARELLI



cod. **0012390**
Batteria YTX14-BS

APPLICABILITÀ

Aprilia Sr Max 125 2011, Dorsoduro 750 2008 - 2010, Dorsoduro Factory 750 2010, Shiver-Gt 750 2007 - 2011, Mana-Mana Gt 850 2007 - 2011, Etv Caponord 1000 2001 - 2008, Rsv-Rsv R 1000 1998 - 2000, SI Falco 1000 1998 - 2003, Dorsoduro 1200 2011

Benelli Adiva 125 2001 - 2002, Adiva 150 2001 - 2002

Bmw F Gs 2C (800Cc) 650 2008 - 2011, F Gs 800 2008 - 2011, F R 800 2009 - 2011, F S-F St 800 2006 - 2011, K R (K43) 1200 2005 - 2008, K R Sport (K43) 1200 2007 - 2009, K S (K40) 1200 2005 - 2008, R Gs (K25) 1200 2003 - 2011, R Gs Adventure (K25S) 1200 2005 - 2009, R R (K27) 1200 2007 - 2011, R S (K29) 1200 2006 - 2007, R St (K28) 1200 2005 - 2006, K R (K43) 1300 2009 - 2011, K S (K40) 1300 2009 - 2011

Buell Xb9r Firebolt 900 2002 - 2007, Xb9s Lightning 900 2003 - 2004, S1 Lightning 1200 1996 - 1999, Xb12r Firebolt 1200 2004 - 2005, Xb12s Lightning 1200 2004 - 2010, Xb12scg Lightning 1200 2005 - 2010, Xb12ss Lightning Long 1200 2006 - 2010, Xb12x Ulysses 1200 2006 - 2010

Cagiva Canyon 600 1996 - 1999, River 600 1995 - 1999, Elefant 750 1988 - 1994, Elefant-Elefant I.E. 900 1991 - 1997

Gilera Nexus le E3 125 2008 - 2010, Nexus le-Nexus Sp le 250 2007, Nexus le E3 300 2008, Gp 800 2009 - 2010

Honda Trx Fourtrax 2X4-4X4 (K-Y) 300 1989 - 2000, Trx D Fourtrax Foreman 4X4 (H-J-K) 350 1987 - 1989, Trx Fe Fourtrax Rancher 2X4-4X4 (Fey-Fe6) 350 2000 - 2006, Trx Fm Fourtrax Rancher 2X4-4X4 (Fmy-Fm6) 350 2000 - 2006, Trx Fourtrax 2X4-4X4 (G-P) 350 1986 - 1993, Trx Te Fourtrax Rancher Es 2X4-4X4 (Tey-Te6) 350 2000 - 2006, Trx Tm Fourtrax Rancher Es 2X4-4X4 (Tmy-Tm6) 350 2000 - 2006, Trx Fa Fourtrax Rancher At (Fa4-Fa7) 400 2004 - 2007, Trx Fw Fourtrax Foreman 2X4-4X4 (Fws-Fw2) 400 1995 - 2002, Trx Fa Fourtrax Rancher (Fa9-Faa) 420 2009 - 2010, Trx Fe Fourtrax Rancher (Fe7-Fea) 420 2007 - 2010, Trx Fm Fourtrax Rancher 4X4 (Fm7-Fma) 420 2007 - 2010, Trx Fpm Fourtrax Rancher (Fpm9-Fpma) 420 2009 - 2010, Trx Te Fourtrax Rancher (Te7-Te9) 420 2007 - 2009, Trx Tm Fourtrax Rancher (Tm7-Tma) 420 2007 - 2010, Trx Es Foreman (Esw-Es1) 450 1998 - 2001, Trx S Foreman (Sw-S1) 450 1998 - 2001, Trx Fa Fourtrax Foreman Rubicon (Fa1-Faa) 500 2001 - 2010, Trx Fe Fourtrax Foreman Rubicon 4X4 (Fe5-Fea) 500 2005 - 2010, Trx Fm Fourtrax Foreman 4X4 (Fm5-Fma) 500 2005 - 2010, Trx Fpe Fourtrax Foreman Power S. 4X4 (Fpe8-Fpea) 500 2008 - 2010, Trx Tm Fourtrax Foreman (Tm5-Tm6) 500 2005 - 2006, Trx Rincon Fa3-Fa4-Fa5 (Std.) 650 2003 - 2005, Nv Gc Shadow (Pc21) 750 1999 - 2001, Vt C2 Shadow (Rc44) 750 1997 - 2001, Xrv Africa Twin (Rd04-Rd07) 750 1993 - 2002, Xlv Varadero (Sd01-Sd02) 1000 1999 - 2002, St Pan European (Sc26) 1100 1990 - 2001, St Pan European Abs (Sc26) 1100 1990 - 2001, Vt C2 Shadow (Sc32-Sc43) 1100 2000 - 2007, Vt C3 Shadow Aero (Sc39) 1100 1998 - 2002, Cb Dc X4 (Sc38) 1300 2001--, Vtx C (Sc52) 1300 2004 - 2007, Vtx S (Sc52) 1300 2003 - 2007, Gl Valkirye F6c (Sc34) 1500 1997 - 2001

Husqvarna Te E 410 1999 - 2001, Sm 610 1998 - 1999, Sm S 610 2000 - 2008, Te 610 1996 - 2000, Te E 610 1998 - 2008, Te Lt 610 2000

Hyosung Gt Comet 125 2004 - 2006, Gt Comet R-le (E2-E3) 125 2006 - 2008, Gt Comet 250 2004 - 2005, Gt Comet R 250 2006 - 2008, Gt Comet S 250 2006 - 2007, Gt 650 2004 - 2005, Gt Comet R - R Ttc 650 2005 - 2008, Gt Comet S 650 2005 - 2008, Gv Aquila 650 2005 - 2007

Italjet Dragster 125 1999 - 2000, Dragster 180 1999 - 2000

Kawasaki Kvf Brute Force 4X4 (Kvf650d-E) 650 2005 - 2008, Kvf Brute Force 4X4 (Kvf650f-G-H) 650 2006 - 2011, Kvf Prairie 4X4 (Kvf650a-B) 650 2002 - 2003, W (Ej650a-E4 - 200010) 650 1999 - 2004, Kfx V-Force (Ksv700a-B) 700 2004 - 2007, Kvf Prairie 4X4 (Kvf700a) 700 2004 - 2006, Kvf Brute Force 750 2005 - 2011, Vn Vulcan (Vn800a) 800 1995 - 1998, Vn Vulcan Classic (Vn800a) 800 1995 - 1998, Vn Vulcan Drifter (Vn800c) 800 1999 - 2003, Klv 1000 2004 - 2005, Gpz (Zx1100e1-E2) 1100 1995 - 1998, Gpz Abs (Zx-F1) 1100 1996 - 1997, Zrx (Zr-D1-D3-C3) 1100 1996 - 2000, Zrx Ninja-Zx11 (Zxt-C-D) 1100 1993 - 2001, Zrx R 1200 2001 - 2006, Zrx S 1200 2001 - 2005, Zx12r Ninja 1200 2000 - 2006, Zrx 1200 2002 - 2005

Kymco Xciting 500 2005 - 2006, Xciting I 500 2006 - 2011, Xciting I R 500 2007 - 2011

Malaguti Spidermax Gt 500 2004 - 2005, Spidermax Rs 500 2008 - 2009

Moto Guzzi Nevada S 750 2010 - 2011

Piaggio Mp3 125 2007 - 2009, Mp3 Hybrid 125 2009 - 2010, Mp3 le-Touring 125 2009 - 2010, X Evo 125 2007 - 2008, X8 Premium E2-E3 125 2006 - 2007, Carnaby 200 2007 - 2008, Beverly Cruiser 250 2007 - 2009, Beverly E3 Mic (Zapm28800) 250 2007 - 2009, Beverly le E3 (Zapm28800) 250 2008 - 2009, Beverly Tourer E3 (Zapm28801) 250 2008 - 2009, Carnaby 250 2008, Mp3 (Zapm47201) 250 2006 - 2008, Mp3 Lt (Zapm64100) 250 2009 - 2010, Mp3 Mic (Zapm63200) 250 2008 - 2009, X Evo (Zapm36401) 250 2007 - 2008, X7 E3 (Zapm62200) 250 2007 - 2009, X8 E3 (Zapm36400) 250 2005 - 2008, Beverly Tourer le (Zapm28400) 300 2009 - 2010, Mp3 le Lt 300 2010 - 2011, Mp3 le Mic 300 2010, Mp3 le Yourban Erl-Nrl 300 2011, Mp3 Lt 4V Ibrid 300 2010 - 2011, Beverly E3 (Zapm343) 400 2006 - 2007, Beverly Tourer E3 (Zapm344) 400 2008 - 2009, X Evo (Zapm52101) 400 2007 - 2009, X8 (Zapm52100) 400 2006 - 2008, Beverly-Beverly E3 (Zapm34100-34200) 500 2006 - 2008, Beverly Cruiser (Zap34500) 500 2007 - 2011

Suzuki Lt A Eiger 2X4 (Fk2-Fk4) 400 2002 - 2004, Lt A Eiger 4X4 (Fk2-Fk7) 400 2002 - 2007, Lt F Eiger 2X4 (Fk2-Fk4) 400 2002 - 2004, Lt F Eiger 4X4 (Fk2-Fk7) 400 2002 - 2007, Lt F Kingquad Fs 4X2 (Fk8-L1) 400 2008 - 2010, Lt F Kingquad Fs 4X4 (Fk8-L1) 400 2008 - 2010, Lt A X Kingquad 450 2007 - 2010, An Burgman 650 2003 - 2011, Dr Rse 650 1989 - 1993, Lt V Twin Peaks 4X4 700 2002 - 2005, Dr Big 800 1991 - 1997, DI V Strom 1000 2002 - 2010, Sv 1000 2003 - 2007, Sv S 1000 2003 - 2007, Gsx 1400 2002 - 2006, Tgb, Blade 250, X Motion Lc 4T 250, Blade Le 325

Triumph Tiger (T409en) 900 1999 - 2000, Trophy (T309st) 900 1992 - 1999, Daytona le (T595) 955 2001 - 2006, Speed Triple (T595) 955 1999 - 2005, Sprint Rs le (T625) 955 2003, Trophy 1200 1999 - 2003

Vespa Gts Super (Zapm45200) 300 2008 - 2011, Gtv Navy E3 (Zapm4102) 250 2008 - 2010, Gts le Super 4V 125 2009 - 2010

Yamaha Yfm R Raptor 660 2001 - 2005, Xj S Diversion 900 1994 - 2003, Fzr 1000 1991 - 1995, Gts-Gts Abs 1000 1993 - 2000, Yzf Thunderace (4Vd) 1000 1996 - 2000, Fj A Fairing Abs 1200 1991 - 1993, Xjr 1200 1994 - 1998

cod. **0012410**
Batteria YB7L-B

APPLICABILITÀ

Harley-Davidson 90 Z90 1973 - 1976, 125 Ss125, Sx125 1974 - 1978, 125 Sxt125 1975 - 1978, 125 Tx125 1973 - 1978, 175 Ss175, Sx175 1974 - 1978, 250 Ss250, Sx250 1975 - 1978

Kawasaki Kawasaki 650 W Series 1966 - 1970

Triumph 650 T120 Bonneville 1936 - 1982, 650 Bonneville 1989 - 1982, 750 T150 Trident 1936 - 1982

Yamaha 80 Yg5t, Yg5s 1968 - 1969, 100 L5t, L5ta 1969 - 1970, 100 Yl2c/Cm 1968, 125 At1e, At1b, At1c 125 Enduro 1969 - 1971, 125 At2, At3 125 Enduro 1972 - 1973, 125 Dt 125 Enduro 1974 - 1981, 125 125 Sr/Sr Se 1992-2003, 185 Sr185

cod. **0012420**
Batteria YB7L-B2

APPLICABILITÀ

Mbk Xn Doodo - 125 Cc - 2000 - 2001, Xq Thunder - 125 Cc - 2001 - 2002, Yp E Skyliner - 125 Cc - 2003 - 2003, Yp Skyliner - 125 Cc - 1998 - 2002, Xn Doodo - 150 Cc - 2001 - 2002, Xq Thunder - 150 Cc - 2001 - 2002, Yp Skyliner - 150 Cc - 2000 - 2002, Yp E Skyliner - 180 Cc - 2003 - 2003

Triumph Bonneville - 650 Cc

Yamaha Xn Teo's - 125 Cc - 2000 - 2003, Xq Maxster - 125 Cc - 2001 - 2002, Yp E Majesty - 125 Cc - 2003 - 2006, Yp E Majesty - 125 Cc - 2007 - 2009, Yp Majesty - 125 Cc - 1998 - 2000, Yp Majesty - 125 Cc - 2001 - 2002, Xn Teo's - 150 Cc - 2001 - 2002, Xq Maxster - 150 Cc - 2001 - 2002, Yp Majesty - 150 Cc - 2000 - 2002, Yp E Majesty - 180 Cc - 2003 - 2006

MINARELLI

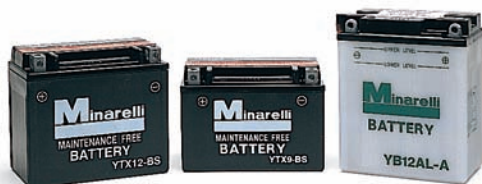

cod. **0012430**
Batteria YTX7L-BS

APPLICABILITÀ

Aprilia	Mojito Cc.150, Mojito Retrò/Custom Cc.125 - 2003-2008, R4 125 Cc.125 - 2011, Sr125 Cc.125 - 1999-2001, Sr150 Cc.150 - 1999-2001
Atk	Atk Tutti I Modelli (Electric-Start) Cc. - 1996-2001
Benelli	Caffenero 125, Caffenero 150
Betamotor	Alp Cc.200 - 2003, Alp 4.0 Cc.400 - , Alp Motard 4.0 Cc.350 - 2003-2008, Motard Cc.400
Bimota	Db3 Mantra Cc.900 - 1997-1999, Sb6, Sb7 Cc.1100 - 1995-1997
Derbi	Atlantis Cc.100 - , Boulevard Cc.125 - 2002-2007, Cross City Eu3 Cc.125 - 2007-2008, Gp1 Cc.125 - 2004-2008, Gpr Cc.125 - 2004-2006, Mulhacen Cc.125 - 2007-2008, Mulhacen Cc.125 - 2012, Rambla Cc.125 - 2008, Senda Cc.125 - 2004-2008, Senda Baja 125 Sm Cc.125 - 2012, Senda Drd 125 R Cc.125 - 2012, Senda Drd 125 Sm Cc.125 - 2012, Terra Cc.125 - 2007-2008, Terra125 Cc.125 - 2007
Garelli	Comfort Cc.125 - 2007-2008, King Cc.150 - 2010, Tiger Cc.125 - 2010

Honda	@ Cc.125 - , @ Cc.150 - , Ca125 Cc.125 - 1995-1996, Ca125 Rebel Cc.125 - 1995-1997, Ca250 T Cc.250 - 1995, Ca250ts Cc.250 - 1997, Cb F Hornet/S 98/01 Cc.600 - 1997, Cb250 Cc.250 - 1991-1997, Cb250 Nighthawk Cc.250 - 1991-1997, Cb250, R Cc.250 - 1994-1999, Cb250fv Hornet Cc.250 - , Cb600 F Cc.600 - 2004-2006, Cb600 F Hornet Cc.600 - 1998, Cb600 F, Hornet, Abs Cc.600 - 2004, Cb600 Sf Cc.600 - 2002, Cb600f (599) Cc.600 - 2004-2006, Cbf 125 Cc.125 , Cbf125 Cc.125 , Cbf600n, Na Cc.600 - 2003-2007, Cbf600s, Sa Cc.600 - 2003-2007, Cbr250r Cc.250 - 2012, Cbr250rr Cc.250 , Cbr400rrr Cc.400 - 1992-1994, Cbx250 Twister Cc.250 , Cg150 Titan Cc.150 , Cmx Cc.125 - , Cmx250 Cc.250 , Cmx250 C Rebel Cc.250 - 1996-2010, Cmx250c3 Cc.250 - 2001, Crf250L Cc.250 - 2012, Dylan Cc.125 - , Dylan Cc.150 - , Fes125, Panteon Cc.125 - 2003, Fes150 Cc.150 - 2003, Foresight 150 Cc.150 - , Gyro Canopy Cc.50 - 2000, Gyro Up Cc.50 - 2000, Gyro X Cc.50 - 2000, Hornet Cc.600 - 1998, Lead Cc.100 - 2008, Nes 110 Vision Cc.110 - 2011, Nes 125 Cc.125 - 2000, Nes125, Dylan Cc.125 - 2000, Nes150 Cc.150 - 2000, Nes150 Z Cc.150 - 2001, Nhx110 Elite Cc.110 - 2010, Nx125 Cc.125 - 1988-1990, Nx125 Transcity Cc.125 - 1997, Nx250 Cc.250 - 1988-1995, Pantheon 4T Cc.125 - , Pantheon 4T Cc.150 - , Pantheon Fes (Kit06) Cc.125 - 2003-2005, Pantheon Fes (Kit06) Cc.150 - 2003-2005, Ses125 Cc.125 - 2000, Ses150 Cc.150 - 2000, Sh Cc.125 - , Sh125i Cc.125 - 2012, Sh150 Cc.150 - , Shadow 125 Cc.125 - 1999, Tc 50 Cc.50 - 2000, Vt125 Shadow Cc.125 , Vt250 Cc.250 - 1990-1995, Vt250c V-Twin Magna Cc.250 - , Vt250cs Cc.250 - 1997, Xr200 Cc.200 - 2000
--------------	---

Kawasaki	250Tr (Bj250f) Cc.250 - 2002, D-Tracker (Lx250e) Cc.250 - 2002, El250 A Cc.250 - 1995, Ex250 Ninja Cc.250 - 1995-2007, Ex250 Ninja 250R Cc.250 - 2008-2011, Ex250-F Ninja Cc.250 - 1995-2007, Gpz250r Ex250 F9-F13 Cc.250 - 1995, Gpz250r Ex250 H5-H9 Cc.250 - 1995, Kl250 Super Sherpa Cc.250 - 2009-2010, Kl250 Super Sherpa Cc.250 - 2000-2004, Kl250g, H Super Sherpa Cc.250 - 1997-2010, Kle250 Anhelò (Le250a) Cc.250 - 1997, Klx, Klx D-Tracker Cc.125 - 2010, Klx250es G1/G2 Cc.250 - 1994-1995, Klx250s Cc.250 - 2006-2010, Zr250a, B Balius Cc.250 - 1991, Zz-R (Ex250h) Cc.250 - 1994, Kfx R B8f Cc.450 - 2008-2012
-----------------	--

Keeway	Logik 125, Logic 150
Kymco	Fox Hunt Cc.125 - 1996, Fox Hunt Cc.150 - 1996, Jockey 125 Cc.125 - 1999, Meteorit Cc.125 - , Zing Cc.125 - 1999, Zing Cc.150 - 1999
Malaguti	Malaguti X3m Cc.125 - 2008
Piaggio	Free 100 4T Cc.100, Motore Go-Kart 200Cc Cc.200, Sfera 4T Cc.125 - 1996-1998, Zip 4 Tempi Euro 2 Cc.50
Sanyang	Husky Cc.125 - 1996-1999, Super Duke Cc.125 - 1996-1999
Suzuki	Dr 125 Sm Cc.125 - 2012, Dr125se, Ses Cc.125 - 1994-1997, Dr200se Cc.200 - 1996-1999, Dr200se Cc.200 - 1996-2010, Dr250s (Europe) Cc.250 - 1990-1995, Dr250s Ep, Er, Es Cc.250 - 1993-1995, Dr350se Cc.350 - 1994-1999, Dzl125 Cc.125 - 2002, Gsr150i Cc.150 - 2011, Gz125 Marauder Cc.125 - 1998-2004, Gz250 Cc.250 - 1999-2008, Gz250 Marauder Cc.250 - 1999-2010, Hs125t Cc.125 , Intruderlc250 Cc.250 - 2002, Rv Van Van K3-K8 Cc.125 - 2003-2008, Rv125 Se, R Cc.125 - 1994, Rv125 Tracker Cc.125 - 2002, Rv200 Cc.200 - 2002, Sixteen 125 Cc.125 - 2010, St250 Cc.250 , Tu250g Cc.250 , Tu250x Cc.250 - 2009-2010, Ux Sixteen K8 Cc.150 - 2008, V1125 Intruder Lc Cc.125 - 2000-2007, V1250 Cc.250 - 2001-2007
Sym	Sym Husky Cc.125 - 1999-2000
Yamaha	Nxc Cygnus X Cc.125 - 2004-2005, Xc Fly One Cc.150 - 1997-1998, Xt R Cc.125 - 2005-2008, Xt X Cc.125 - 2005-2008, Xt225 Serow Cc.225 - 1992-2000, Xt225, E, Ec, F, Fg, G, Gc Cc.225 - 1993, Xt250v Cc.250 - 2006, Xt250 Cc.250 - 2007, Ybr Cc.250 - 2007, Ybr 125 Custom Cc.125 - 2011, Ybr125sed Cc.125 - 2007-2009, Ys250 Cc.250 - 2007

cod. **0012470**
Batteria YTX12A-BS

APPLICABILITÀ

Aprilia	RSV4 R - 1000 cc - anni: 2011 - , RSV4 R Factory - 1000 cc - anni: 2011 - , Tuono V4 R - 1000 cc - anni: 2011
Benelli	Tornado LE - 900 cc - anni: 2000 - , Tornado RS - 900 cc - anni: 2000 - , Tornado Tre - 900 cc - anni: 2000
Ducati	998 R - 998 cc - anni: 2002 - 2004, 998 S - 998 cc - anni: 2002 - 2004
Kawasaki	J300 - 300 cc - anni: 2014 - Rif. Originale 26012Y004, ER-6F - 1000 cc - anni: 2012 - , ER-6N - 1000 cc - anni: 2012 - , Z1000 - 1000 cc - anni: 2014 - , Z1000 SX - 1000 cc - anni: 2014
Kymco	Downtown i - 125 cc - anni: 2009 - , People GTi - 125 cc - anni: 2010 - , Dink i - 200 cc - anni: 2006 - 2007, Downtown i - 200 cc - anni: 2010 - , People GTi - 200 cc - anni: 2010 - , Downtown i - 300 cc - anni: 2009 - , G-Dink - 300 cc - anni: 2012 - , K-XCT - 300 cc - anni: 2014 - , People GTi - 300 cc - anni: 2010

Suzuki	AN Burgman - 250 cc - anni: 2003 - 2006, AN Burgman - 400 cc - anni: 2003 - 2006, SFV Gladius - 650 cc - anni: 2009 - , SV - 650 cc - anni: 1998 - 2002, SV S - 650 cc - anni: 1998 - 2002, GSX-R - 750 cc - anni: 2000 - 2003, GSX-R - 750 cc - anni: 2004 - 2005, GSX-R - 750 cc - anni: 2006 - , GSX-R - 1000 cc - anni: 2005 - 2006, GSX-R - 1000 cc - anni: 2007 - , TL R - 1000 cc - anni: 1998 - 2000, GSF Bandit - 1250 cc - anni: 2007 - , GSF Bandit - 1250 cc - anni: 2010 - , GSX-R Hayabusa - 1300 cc - anni: 1999 - 2006
---------------	--

MINARELLI

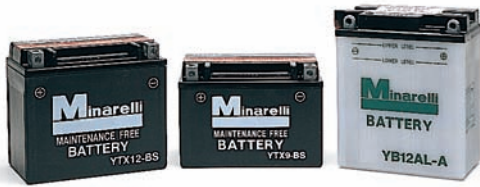

cod. 0012480 Batteria YB10L-B

APPLICABILITÀ

Gilera 125 Dna 01/-, 180 Dna 01/-, 180 Runner Fxr 97/02, 180 Runner Sp 99/02, 200 Runner Vxr 4T 02/06, 200 Runner Vxr Race / St 4T E3 06/07, 250 Arizona Rally, 250 Rv Ngr 86/-

Kawasaki 200 Z (Kz200a1/A1a/A2) 78/79

Piaggio 125 Beverly Sport 07/08, 125 Beverly Tourer 08/09, 125 Carnaby 07/09, 125 Carnaby 07/09, 125 Hexagon Lx4 98/99, 125 Liberty 4T E3 07/08, 125 Liberty Sport/Sport E3 06/08, 125 Superhexagon Gtx 11" 00/01, 125 Superhexagon Gtx 12" 01/02, 125 Vespa Granturismo E3 (Zapm31100/01) 03/07, 125 Vespa Lxv E3 06/09, 125 Vespa S 07/08, 125 X7 E3/X7 Evo Ie E3 07/08, 125 X8 03/04, 125 X9 01/02, 125 X9 Evolution 07, 150 Liberty E3 08/09, 150 Liberty Sport E3 08/09, 150 Vespa Lx E3 06/08, 180 Hexagon Lxt 98/99, 180 Superhexagon Gtx 00/01, 180 X9 Amalfi 00/03, 200 Liberty Sport / Liberty Sport E3 06/07, 200 X8 03/04, 200 X9 02/03, 200 X9 Evolution 03/-, 200 Hexagon Gt 98/99, 250 Superhexagon Gtx 00, 250 X9 00/03

Suzuki 550 Gsx E/Est/L 75/77, 550 Gsx E/Est 79/81

cod. 0012490 Batteria YB14-A2

APPLICABILITÀ

Honda 600cc XL R anni 1983-1987, 600cc XL RM/LM anni 1985-1987, 650cc CX C anno 1983, 750cc CBX F anni 1982-1986, 750cc VF C Shadow / Magna anni 1982-1986, 750cc VF F Interceptor anni 1983-1984, 750cc XLV R anni dal 1983

Kymco 300cc MXU / MXU R anni 2010-2011, 400cc MXU anni 2008-2010

Piaggio PIAGGIO Beverly 500

cod. 0012500 Batteria YTZ7S-BS

APPLICABILITÀ

Bmw 450 G SMR 09, 450 G X 08/09

Honda 50 NPS Zoomer 05/10, 125 CBR R (JC34) 04/06, 125 CBR R (JC34) 07/10, 125 CRE F X 4T 08/10, 125 CRM F X 4T 08/10, 125 VT C Shadow 01/03, 125 XLV Varadero 01/10, 450 CRF X (PE06) 05/09, 450 TRX ER Sportrax 06/09, 500 CRF X (HM ITALIA) 05/09, 600 CB F Hornet (PC 34) 02, 600 CB F Hornet S (PC 34) 02, 1000 CBR RR Fireblade 08/10

Husaberg 450 FE 70° Engine 09/10, 450 FE E 04/08, 450 FE 70° Engine 10, 550 FE E 04/07, 550 FS E 04/08, 570 FE 70° Engine 09/10, 650 FE E 04/07, 650 FS C 06/08, 650 FS E 04/07

Husqvarna 250 SM R 05/08, 250 TCX Cross Country 08/09, 250 TE 02/08, 400 SM R 02/07, 450 SM R 03/08, 450 SM RR 06, 450 SM RR 09, 450 TE 02/08, 450 TCX Cross Country 08, 510 SM R 05/08, 510 TE 04/08, 510 TE R 04, 510 TCX Cross Country 08, 510 TCX Cross Country 08

Kawasaki 450 KLX R 07/10

Rieju 250 Marathon 09/10, 450 Marathon 09/10

Suzuki 250 DR-Z 01/07

Yamaha 125 DT-RE (1D0/1D04) 05/06, 125 DT X Supermotard (2C81/2C82) 05/06, 125 TW/TW R-S 04, 125 XVS Drag Star 00/04, 250 WR F 08/10, 250 WR R 4T 08/09, 250 WR X 4T 08/09, 250 XG Tricker 05/07, 250 XVS Drag Star 01/04, 250 YFM R Raptor 08/09, 450 WR F 03/10, 450 YFZ R 09/10, 450 YFZ X 10

cod. 0012510 Batteria YTZ12S-BS

APPLICABILITÀ

Bmw 1000Cc S Rr 2009-2011, 1200Cc Hp2 2006-2009, 1200Cc Hp2 Megamoto 2007-2010, 1200Cc Hp2 Sport 2008-2011

Honda 1000Cc Vtr F Fire Storm 2001-2005, 1000Cc Vtr Sp1 - Vtr Sp2 - Rc51 2000-2006, 1100Cc Cb Sf Xeleven X11 2001-2003, 1100Cc Cbr Xx Superblackbird 2001-2006, 250Cc Nss Forza X, Ex 2005-2009, 250Cc Nss Jazz 2001-2004, 300Cc Sh / Abs 2007-2011, 400Cc Fjs Silver Wing 2006-2008, 400Cc Fjs Silver Wing T 2009-2011, 600Cc Fjs Silver Wing 2001-2009, 600Cc Fjs Silver Wing Abs 2003-2009, 650Cc Xlv Transalp 2000-2007, 750Cc Vt C / Ca Shadow 2004-2007, 800Cc Vfr Fi 2001-2002, 800Cc Vfr Vtec 2002-2010, 800Cc Vfr X Cross Runner 2011

Yamaha 530Cc T-Max 2012, 800Cc Fz8-N 2010-2012, 1200Cc Xtz Superténéré 2010-2012

cod. 0012520 Batteria YT7B-BS

APPLICABILITÀ

Bombardier Bombardier Ds450 Cc. 450 09-10

Ducati 1199 Panigale, S Cc. 1199 2012, Panigale 1199 Cc. 1199 2011

Kawasaki Kawasaki Klx400r, Klx400sr Cc. 400 03-04

Ktm Duke Cc. 125 2011, Cc. 200 2012

Kymco Quannon Cc. 125 -, Quannon Cc. 150 -, Quannon Naked Cc. 125 2010-

Mbk MbK X-Over Cc. 125 2010-

Suzuki Suzuki Dr-Z400, E, S, Sm Cc. 400 00-10

Triumph Triumph Daytona 675 Cc. 675 06-11

Yamaha Nxc Gygnus X Cc. 125 07-08, Tt250 Cc. 250 99-03, Ttr225 Cc. 225 99-05, Ttr250, V Cc. 250 99-06, Xc100 Cc. 100 2007, Xc125, Cr Cc. 125 07-09, Xenter 125 Cc. 125 2012, Yp250 Dx/Abs Majesty Cc. 250 96-, Yp250 Majesty Cc. 250 2000-, Yw125 Cc. 125 2009-, Yfz S Cc. 450 2004, Yfz450 Cc. 450 04-10, Yfz450, Sew, V Cc. 450 04-09, Yfz450x Cc. 450 2008, Yfz450x Cc. 450 -2012

MINARELLI

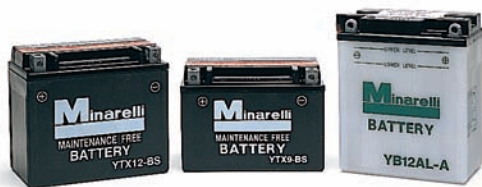

cod. 0012530 Batteria YT9B-BS

APPLICABILITÀ

Kymco Grand King 125 Fi Cc.125, Ktr 150 Cc.150
Mbk MbK Xt660r Cc.660

Yamaha Mt-03 Cc.660 - 06-10, T-Max Cc.500 - 2000, Tt600r Cc.600 - 2004, Xp T-Max Cc.500 - 01-07, Xt600r Cc.660 - 04-10, Xt600x Cc.660 - 04-10, Xt660z (Eu) Cc.660 - 04-10, Xtz660 Tenere Cc.660 - 2008, Yp Majesty Cc.400 - 03-10, Yp250, L, C, G Cc.250 - 2004, Yzf-R6, R6s Cc.600 - 01-05, Yzf-R6, S, Sc, Sv Cc.600 - 01-05, Yzf-R7, Owo2 Cc.750 - 1999, Yfm Rr Cc.700 - 2007, Yfm700 Raptor Cc.700 - 06-10, Yfm700r Cc.700 - 2009

cod. 0012540 Batteria YTZ10S

APPLICABILITÀ

Aprilia Rsv 1000 4V Factory Cc.1000, Rsv Cc.450 - 2008, Rsv Cc.550 - 2008, Sxv 450 Us Cc.450, Sxv 550 Usa Cc.550, Turono V4r Cc.1000 - 2011

Bmw Bmw S1000rr Cc.1000 - 2009

Honda Cb1000r Cc.1000 - 09-10, Cb400 Super Four Cc.400 - 2001, Cb400sf/Sb Cc.400 - 2010, Cb500 Cc.500 - 2004, Cb600f Cc.600 - 07-08, Cb900f Hornet Cc.900 - 2001, Cb1000f Cc.1000 - 09-10, Cb500 Cc.500 - 2004, Cb600 Cc.600 - 2007, Cbr 900F Cc.919 - 02-06, Cbr1000rr (Abs) Cc.1000 - 2010, Cbr1000rr Fireblade (Sc57) Cc.1000 - 04-07, Cbr600 F4i Cc.600 - 01-05, Cbr600 F4i,600Rr Cc.600 - 2001, Cbr600f/Sp Cc.600 - 2001, Cbr600fs/Sx Cc.600 - 2001, Cbr900rr Fireblade Cc.900 - 00-02, Cbr929rr Cc.929 - 2000, Cbr954rr Cc.954 - 2001, Nt650v Cc.650 - 2001, Nv 400 Steed Cc.400 - 2001, Nv400 Dc Shadow Skasher Cc.400 - 2001, Vt400s Cc.400 - 2010, Vt600 C, Cd Shadow Deluxe Cc.600 - 04-07

Ktm Adventure Cc.640 - 03-05, All Sm Cc.625 - 2003, Duke li Cc.640 - 03-05, Duke li Schwarz, Lc4, Adventure Cc.640 - 2003, Duke, Supermoto Cc.690 - 09-10, Euduo Cc.690, Lc4 Cc.640 - 03-05, Smc Cc.625 - 03-09, Supermoto Cc.640 - 03-05, Sxc Cc.625 - 03-09

Kymco People S 2001 Cc.200 - 2007, Vp125 Fi Cc.125 - 2011

Mv Agusta Brutale Cc.910 - 05-08, Brutale 675 Cc.675 - 2011, Brutale 920 My2012 Cc.920 - 2012, Brutale 990 R Cc.990 - 2011, Brutale R 1090 Cc.1090 - 2011, Brutale Rr 1090 Cc.1090 - 2011, F3 675 Cc.675 - 2011, F4 R Cc.1000 - 2012, F4 Rr Cc.1000 - 2012, F4 Series Cc.1000 - 05-10, F4, Brutale Cc.750 - 00-06, F4, Brutale(989,1078) Cc.1078 - 05-10

Sym Citycom 300 Efi Cc.300 - 2010

Suzuki Suzuki Lt-R Quadrcr Cc.450 - 06-10

Yamaha Raptor Cc.350 - 04-05, Yfm 350Rv Raptor Cc.350 - 04-05, Yfm 35Rr Cc.350 - 2008, Yfm S Cc.350 - 2008, Yfm350Raptor Cc.350 - 07-10, Cp250, V Cc.250 - 2005, Fz8 Fazer Cc.779 - 2010, Fz8, R Cc.800 - 2010, Fzs1000 Fz1 Cc.1000 - 06-10, Maxam Cc.250 - 2010, Morphous Cc.250 - 06-07, Xp T-Max Cc.500 - 2008, Xp500 T-Max Cc.500 - 09-10, Xp500, A, Y Cc.500 - 08-09, Yp250 Cc.250 - 2007, Yzf-R1, W, Wc Cc.1000 - 2004, Yzf R6 Cc.600 - 06-10, Yzf R6 Limited Edition Cc.600 - 2007, Yzf-R1 Lev Cc.1000 - 2006, Yzf-R1, Y, Yc Cc.1000 - 04-10, Yzf-R1s Cc.1000 - 2006, Yzf-R6, W, Ec Cc.600 - 06-09

cod. 0012550 Batteria YT12B-BS

APPLICABILITÀ

Aprilia Sport City Cc.125 - 04-11, Sport City Cc.250 - 06-07, Sportcity Cc.200 - 04-06

Benelli Benelli Tornado Cc.900 - 02-05

Cagiva Cagiva Navigator Cc.1000

Ducati 1098 Cc.1100 - 2007, 1098 S Cc.1098 - 07-09, 1198 My08, Sp, R Cc.1198 - 2010, 125 Multistrada Cc.1200 - 2007, 696 Monster Cc.696 - 09-10, 749 Cc.749 - 03-06, 848 Cc.848 - 2008, 998 Cc.998 - 02-07, 999 Biposto, S, R Cc.999 - 2003, Desmosedici Rr Cc.1000 - 2008, Diavel Cc.1200 - 2011, Gt Europe Cc.1000 - 2007, Gt1000, Touring Cc.1000 - 2009, Hypermotard Cc.1100 - 2008, Hypermotard Evo Sp Cc.1078 - 2010, M Chromo Cc.900 - 2001, M Dark Cc.600 - 2001, M Dark Cc.750 - 2001, M le/ M le Dark Cc.750 - 2002, M le/ M le Dark2 Cc.900 - 2002, M Metallic/M S Cc.900 - 2001, Monoposto, Biposto Cc.998 - 2001, Monster Cc.400 - 2001, Monster Cc.400 - 02-04, Monster Cc.800 - 2010, Monster Cc.600 - 01-07, Monster Cc.620 - , Monster Cc.750 - 2000, Monster Cc.800 - 03-04, Monster Cc.900 - 01-07, Monster 1100 Cc.1100 - 09-10, Monster 695/696 Cc.700 - 07-08, Monster Dk, le Cc.400 - 05-08, Monster S Cc.800 - 2003, Monster S/S2r/S4rs Cc.1000 - 03-08, Monster S2r Cc.800 - 2004, Monster S4 Cc.916 - 01-07, Monster S4r Cc.996 - 03-06, Monster/le/S le/Sport Cc.620 - 02-03, Monoposto, Biposto, S Cc.996 - 2001, Multistrada Cc.1000 - 03-06, Multistrada Cc.1100 - 2007, Multistrada Cc.650 - 2007, Multistrada Cc.620 - 2006, Multistrada, Multistrada Pikes Peak Cc.1200 - 2012, New Monster Cc.750 - , Paul Smart L.E. Cc.1000 - 2006, Rs Cc.999 - 04-05, S R Cc.748 - 2001, S, Hypermotard Cc.1100 - 07-10, Sport Cc.620 - 2003, Sport Cc.750 - 2001, Sport Cc.750 - 2002, Sport Cc.800 - 2003, Sport Cc.900 - 1999, Sport 1000 Cc.1000 - 2006, Sport S Biposto, Gt St3 Cc.1000 - 01-07, Sport Touring 4 Cc.916 - , Sport Touring 4S Cc.996 - 2001, Sps, R Cc.996 - 2000, Sr Cc.748 - 01-02, Ss Cc.900 - 01-07, Ss Cc.800 - 2007, Ss Cc.750 - 01-02, Ss le Cc.750 - 01-02, Ss le Cc.900 - 01-02, St 2 Cc.944 - 2001, St3 Cc.1000 - 04-07, St3 Cc.992, St4 Cc.916 - 2001, St4s Cc.996 - 2001, Strada Biposto, Sp, Sps Cc.748 - 01-02, Street Fighter, S Cc.1100 - 2009, Streetfighter 848 Cc.848 - 2011, Superbike 1098, S, Tricolore Cc.1098 - 2007, Superbike 749R, S Cc.749, Supersport Cc.800 - 03-07, Supersport Hf Cc.1000 - 2003, Supersport Hf Cc.1000 - 2003, Supersport le Cc.900 - 01-02, Tutti Gli Altri Modelli / All Other Models Cc.1098 - 01-10

Gilera Gilera Runner Vxr 4T Cc.180

Kawasaki Zx 10 R Ninja Cc.1000 - 04-10, Zx10 R Cc.1000 - 04-10, Zx1000-C Ninja (Zx-10R) Cc.1000 - 04-10, Zx1000-C Ninja Zx-10R Cc.1000 - 04-09

Moto Guzzi Moto Guzzi V10 Centauro Cc.1000

Piaggio Piaggio Beverly Cc.200 - 2001

Triumph America Cc.865 - 09-10, Bonneville T100, Se Cc.865 - 09-10, Scrambler Cc.865 - 09-10, Speedmaster Cc.865 - 09-10

Yamaha Ftz6 Fazer Cc.600 - 04-05, Fz6 Fazer Cc.600 - 04-08, Fz6, Ns, S2 Cc.600 - 04-08, Fz6, R Cc.600 - 05-10, Fzs6 Cc.600 - 2004, Fzs600 Fazer Cc.600 - 1999, Fzs600s Fazer Cc.600 - 2000, Srx600 Cc.600 - 2010, Tdm 02 Cc.900 - , Tdm850, N Cc.850 - 1991, Tdm900 (Eu) Cc.900 - 2010, Tdm900, A Cc.900 - 2004, Xj6 (Abs) Cc.600 - 2012, Xj6 Diversion, F Cc.600 - 2012, Xj6 Diversion, F Cc.600 - 2010, Xj600s Cc.600 - 2009, Xj6n, Na, S, Sa, Sy Cc.600 - 2009, Xvs400, C Cc.400 - 2004, Xvs650 Drag Star Cc.650 - 97-06, Xvs650 V-Star Cc.650 - 98-09, Xvs650, W, Wc Cc.650 - 1997, Xvs650a Drag Star Cla. Cc.650 - 2000, Xvs650v, Vc Cc.650, Yzf-R1 Cc.1000 - 99-03, Yzf-R6 Cc.600

MINARELLI

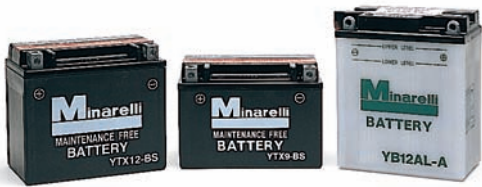

◀ cod. 0012560 Batteria 52015

APPLICABILITÀ

Bmw	450Cc R 45-20Kw / R 45-26Kw 1975-1985, 500Cc R 50 / R 50 S / R 50/2 / R 50/5 1955-1973, 500Cc R 50/5 1969-1973, 600Cc R 60 Ls, 600Cc R 60/5 / R 60/6 / R 60/7 1969-1978, 650Cc R 65 1978-1991, 650Cc R 65 Gs 1986-1991, 650Cc R 65 Ls 1982-1985, 650Cc R 65/1 1986-1991, 750Cc R 75/5 1971-1974, 800Cc R 80 Gs 1977-1979, 800Cc R 80 Gs 1980-1987, 800Cc R 80 Gs Mystic 1991-1995, 800Cc R 80 Gs Paris Dakar 1988-1995, 800Cc R 80 St 1980-1986, 900Cc R 90 St 1973-1976, 1000Cc K1 1989-1995, 1000Cc R 100 Gs / R 100 Gs Parigi Dakar 1987-1996	Bmw	450Cc R 45-20Kw / R 45-26Kw 1975-1985, 500Cc R 50 / R 50 S / R 50/2 / R 50/5 1955-1973, 500Cc R 50/5 1969-1973, 600Cc R 60 Ls, 600Cc R 60/5 / R 60/6 / R 60/7 1969-1978, 650Cc R 65 1978-1991, 650Cc R 65 Gs 1986-1991, 650Cc R 65 Ls 1982-1985, 650Cc R 65/1 1986-1991, 750Cc R 75/5 1971-1974, 800Cc R 80 Gs 1977-1979, 800Cc R 80 Gs 1980-1987, 800Cc R 80 Gs Mystic 1991-1995, 800Cc R 80 Gs Paris Dakar 1988-1995, 800Cc R 80 St 1980-1986, 900Cc R 90 St 1973-1976, 1000Cc K1 1989-1995, 1000Cc R 100 Gs / R 100 Gs Parigi Dakar 1987-1996
Ducati	Ducati 600Cc Monster Vigili Urbani 1993-2001	Laverda	350Cc 4T 1978-1981, 500Cc 4T 1976-1983, 650Cc Ghost Dal 1996, 650Cc Strike Dal 1996, 668Cc Diamante Dal 1996, 668Cc Strike Dal 1997
		Moto Guzzi	350Cc Gts 4C 4T 1974-1981, 400Cc Gts 4C 1975-1980
		Moto Morini	Moto Morini 350Cc Sport 2C 1973-1982

◀ cod. 0012570 Batteria 52015

APPLICABILITÀ

Derbi	125Cc Gp 1 2006-2008, 250Cc Gp 1 2005-2006, 250Cc Gp 1 E3 2007-2009	Piaggio	125Cc X8 2005-2006, 125Cc X8 Premium E2/E3 2006-2007, 125Cc X8 Street E2 2006-2007, 150Cc X8 Street 2006-2008, 200Cc Liberty Rst / Liberty Rst E3 2004-2005, 200Cc X8 2005-2007, 250Cc Beverly le E3 2006-2007, 250Cc Beverly Rst 2004-2005, 250Cc Beverly Sport 2006-2012, 250Cc Vespa Gt 60 2006-2007, 250Cc Vespa Gts / Gts Abs 2005-2009, 250Cc Vespa Gtr 2006-2010, 250Cc X8 E3 2005-2008, 250Cc X9 Evolution 2004-2006, 500Cc Beverly / Beverly E3 2002-2005
--------------	---	----------------	--

◀ cod. 0012580 Batteria 52015

APPLICABILITÀ

Benelli	899Cc Century Racer 2010-2011, 899Cc Tnt 2007-2011, 899Cc Tre K 2007-2011, 1130Cc Tnt 2005-2006, 1130Cc Tnt Café Racer, Sport, Titanium 2005-2008, 1130Cc Tornado Tre 2007-2008, 1130Cc Tre K 2006-2011, 1130Cc Tre K Amazonas 2007-2011	Kawasaki	1400Cc Gtr 2007-2010, 1400Cc Zzr 2006-2010
Bmw	Bmw1200cc R Gs Adventure 2010-2011	Ktm	950Cc Lc8 Adventure 2002-2005, 950Cc Lc8 Rallye 2002-2003, 950Cc Lc8 Super Enduro R 2007-2009, 950Cc Lc8 Supermoto 2006-2007, 990Cc Adventure 2006-2010, 990Cc Adventure R 2009-2010, 990Cc Adventure S 2006-2008, 990Cc Super Duke / R 2005-2010, 990Cc Supermoto / T 2007-2010, 990Cc Supermoto R 2007-2010, 1190Cc Rcl / R 2008-2010
Derbi	Derbi 660Cc Mulhacen 2006-2008	Yamaha	950Cc Xvs Midnight Star 2009-2012, 1000Cc Fz1-N 2006-2012, 1000Cc Fz1-S Fazer / Fazer Abs 2006-2012, 1300Cc Xjr 2007-2011, 1700Cc Vmx V-Max 2009-2012
Honda	650Cc Nt V Deauville 2004-2005, 700Cc Nsa Dn-01 2008-2012, 700Cc Nt V Deauville Abs 2006-2011, 700Cc XI V Transalp 2008-2012, 700Cc XI V Transalp Abs 2008-2012, 750Cc Vt C / Ga Shadow 2008-2010, 750Cc Vt C Shadow 1997-2000, 750Cc Vt C2 Shadow Spirit 2007-2009, 750Cc Vt C2b Shadow Spirit 2010-2011, 750Cc Vt C2f Shadow Spirit Anno 2009, 750Cc Vt C2s Shadow Spirit 2010-2011, 750Cc Vt Cs 2010-2011, 750Cc Vt Dc1 / Dc2 Black Widow 2001-2002, 750Cc Vt S 2010-2011, 1200Cc Vfr 2010-2011, 1300Cc Cb F/Sf 2001-2011, 1300Cc Six Pan European 2002-2011, 1300Cc Vtxc Anno 2010		

MINARELLI



◀ cod. **0012590**
Batteria 52015

APPLICABILITÀ

<p>Aprilia 350cc ETX 1986-1992, 350cc Tuareg Wind 1987-1992, 500cc Atlantic 2001-2004, 500cc Scarabeo 2002-2006, 600cc ETX 1986-1992, 600cc Pegaso 1990-1992, 600cc Tuareg Wind 1987-1992, 650cc Pegaso / Cube / IE 1990-1996, 650cc Stark / Moto 6,5 1995-2000</p> <p>Bmw 125cc C1 2000-2003, 200cc C1 2000-2003</p> <p>Cagiva 350cc Elefant dal 1989, 350cc T4E 1987-1994, 350cc W12 dal 1992, 500cc T4E 1987-1994, 600cc W16 1994-1996, 650cc Elefant 1985-1989</p> <p>Ducati 350cc F3 dal 1985, 350cc Indiana dal 1986, 350cc SL Pantah dal 1983, 350cc TL Pantah dal 1983, 350cc XL Pantah 1982-1984, 500cc GTL Twin Parallelo 1974-1979, 500cc SL Pantah 1978-1989, 600cc SL Pantah 1981-1985, 600cc TL Pantah 1982-1985, 650cc Indiana 1983-1992, 750cc F1 1987-1991, 750cc Indiana 1986-1991, 750cc Paso 1987-1990</p> <p>Gilera 250cc Nexus IE / Nexus SP IE 2006, 350cc XRT dal 1988, 500cc Nexus / Nexus E3 / Nexus SP E3 2003-2009, 600cc Nordwest 1993, 600cc RC C 1993, 600cc RC Top Rally dal 1990, 600cc XRT 1989</p> <p>Honda 1100cc CB F bol d'or 1981-1983, 500cc CX 1978-1982, 500cc CX E dal 1982, 500cc CX T Turbo 1982, 500cc FT Ascot 1982-1983, 500cc GL Silver Wing 1981-1982, 650cc CX E Euro 1983-1986, 650cc CX Turbo 1983, 750cc CB F Bol d'or, A,B,C,2C 1980-1982, 750cc CB K Four Z,A,B 1978-1982, 900cc CB C Custom 1980-1982, 900cc CB F 1981-1982, 900cc CB F Bol d'or 1979-1981, 900cc CB F Bol d'or 2C, D, 2D 1982-1983</p>	<p>Kawasaki 1000cc Z 1977-1980, 1000cc Z 1R Series 1978-1980, 1000cc Z Classic 1980, 1000cc Z LTD 1977-1980, 1000cc Z Police 1978-1981, 1000cc ZL Eliminator 1987, 1000cc ZX10 Tomcat Ninja 1988-1990, 1100cc ZZR Ninja / ZX11 1990-1992, 500cc GPZ (EX R NINJA) 1987-1993, 500cc GPZ (EX R NINJA) 1994-2005, 600cc KLR 1985-1988, 650cc KL Tengai 1989-1991, 650cc KLR 1987-1997, 750cc GPX R 1986-1989, 750cc VN Vulcan A2,A13 1986-1994, 750cc Z B 1976-1978, 750cc ZXR 1988-1990, 900cc GPZ R Ninja 1984-1993</p> <p>Laverda 650cc Sport/Formula 1995-2001, 750cc Sport/Formula 1997-2001</p> <p>Moto Guzzi 750cc Brevia 2003-2007, 750cc Nevada Classic - Aquila nera 2004-2008</p> <p>Moto Morini MOTO MORINI 350cc Dart 1988-1994</p> <p>Piaggio 500cc X9 2001-2003, 500cc X9 Abs 2006-2008, 500cc X9 Evolution 2004-2007, 500cc X9 Evolution Abs 2004-2005</p> <p>Suzuki 1000cc GS 1978-1982, 1100cc GS G 1982-1984, 1100cc GSX F 1988-1993, 1100cc GSX R 1986-1992, 1200cc GV GL Madura 1985-1986, 650cc GR Temper 1983, 650cc GS E 1981-1982, 650cc GS G 1981-1983, 650cc GS GL 1981-1983, 650cc LS P Savage 1986-2005, 650cc XN85 Turbo 1983, 750cc GS 1977-1983, 750cc GS E 1983, 750cc GS S Katana 1983, 750cc GSX E 1982-1983, 750cc GSX ES 1980-1985, 750cc GSX ES 1986-1988, 750cc GSX ET 1980-1986, 750cc GSX L 1980-1982, 750cc GSX R 1985-1991, 750cc GSX S Katana SD,SZ,S3 1984-1985, 850cc GS 1979-1986, 850cc GS G 1979-1983, 850cc GS GL 1979-1983</p>	<p>Triumph 1000cc Daytona 1991-1995, 1200cc Daytona 1993-1994, 1200cc Trophy 1991-1998, 750cc Daytona 1991-1995, 750cc Trident 1991-1998, 885cc Speed Triple 1997-1998, 900cc Adventurer 1996-2002, 900cc Daytona 1991-1999, 900cc Daytona Super 3 1994-1999, 900cc Legend TT 1999-2001, 900cc Speed Triple 1994-1996, 900cc Thunderbird 1995-2002, 900cc Thunderbird Sport 1995-2002, 900cc Tiger 1994-1998, 900cc Trident 1991-1998, 900cc Trophy 1991, 955cc Daytona 1996-1998, 955cc Daytona IE 1999-2000, 955cc Sprint RS IE 1999-2002, 955cc Sprint ST 1999-2004, 955cc Tiger 2001-2005</p> <p>Yamaha 1000cc FZR 1987-1990, 1100cc FJ 1984-1987, 1200cc FJ Fairing 1986-1992, 500cc TX 1973-1974, 500cc XS 1975-1978, 550cc XZ R Vision 1982-1983, 650cc TX 1974, 650cc XJ dal 1981, 650cc XS 1975-1983, 700cc FZ Genesis 1987, 700cc FZX Fazer 1986-1987, 700cc XJ Maxim 1986-1987, 700cc XJ X Maxim X 1985, 750cc FZ 1985-1990, 750cc FZR R Genesis 1987-1988, 750cc FZX 1987-1994, 750cc XJ 1981-1983, 750cc XJ Maxim 1982-1985, 750cc XJ R Seca 1982-1983, 750cc XS 1977-1979, 850cc XS 1980-1981, 900cc XJ 1983-1992, 900cc XJ R Seca 1983</p>
--	---	---



◀ cod. **AA00780**
Perno pompa acqua con girante motore scooter 50 cc Minarelli/Yamaha



◀ cod. **AA00785**
Traino per girante pompa acqua motore scooter 50 cc Minarelli/Yamaha



◀ cod. **AA00786**
Gommino su perno traino pompa acqua motore scooter 50 cc Minarelli/Yamaha



◀ cod. **AA00787**
Perno per traino girante pompa acqua motore scooter 50 cc Minarelli/Yamaha



◀ cod. **AA00788**
Kit revisione pompa acqua per scooter 50 cc Minarelli/Yamaha

APPLICABILITÀ

Aprilia	Area 51 50 2T 98-00, Gulliver LC 50 2T 96-98, Rally Liquid Cooled 50 2T 96-99, SR Liquid Cooled 50 2T 94-96, RS 50 50 2T 91-05, RX 50 50 2T 03-04, RX 50 3-5 Marce 50 2T 91-94, RX 50 Enduro 50 2T 95-03, RX 50 Racing 50 2T 03-06, Tuono 50 50 2T 03-04
Benelli	491 RR 50 2T 99-01, 491 Racing 50 2T 98-99, 491 SP 50 2T 99-99, 491 Sport 50 2T 98-99, K2 Liquid Cooled 50 2T 98-01
Beta	Ark LC 50 2T 96-08, Eikon 50 2T 99-03
Italjet	Dragster 50 2T -00

Malaguti	F12 Phantom Euro 2 50 2T 02-02, F12 Phantom LC 50 2T -00, F12 Phantom LC Euro 2 2,3 50 2T 03-04, F12 R Phantom LC 50 2T 07-09, F12 Restyling Euro 1 50 2T 99-02, F12 Restyling LC Euro 2 50 2T 06-06, F15 Firefox 50 2T -00, F15 Firefox Euro 2 50 2T 02-06, F15 Firefox Euro 2 2,3 50 2T 03-04
Mbk	Mach G LC 50 2T 02-04, Nitro 50 2T -00, Nitro Euro 2 50 2T 03-03
Yamaha	Aerox 50 2T -00, Aerox Euro 2 50 2T 03-03, Jog R LC 50 2T -00

RICAMBIO

AA00784	Paraolio BA 10 18 4 Corcos
----------------	----------------------------

◀ cod. **AA00789**
Kit revisione pompa acqua per motore Minarelli AM6

APPLICABILITÀ

Aprilia	Classic 50 2T 92-99, Europa 50 2T 91-92, MX 50 50 2T 04-04, MX 50 Motard 50 2T 95-03, Pegaso 50 2T 92-94, RS 50 50 2T 91-05, RX 50 50 2T 03-04, RX 50 3-5 Marce 50 2T 91-94, RX 50 Enduro 50 2T 95-03, RX 50 Racing 50 2T 03-06, Tuono 50 50 2T 03-04
Beta	RR Alu 50 2T 00-, RR Enduro 50 50 2T 00-, RR Motard 50 50 2T 00-
CH Husquarna	SM 50 50 2T -00, WR 50 50 2T -00, WSM 50 50 2T -00
CMC	Enduro 50 50 2T 11-11, Motard 50 50 2T 11-11
Fantic	Caballero Motard 50 2T 06-10, Caballero Regularità 50 2T 06-10
HM	Baja, Derapage Basic 50 2T 10-11, CMC 50 2T 10-11, CRE Baja RR, Derapage RR 50 2T 07-11, CRE Baja, Derapage 50 2T 07-11, CRE Six Competition 50 2T 10-11, CRE Six, Baia, Derapage 50 2T 95-06, CRE Six, Derapage Competition 50 2T 07-09, Derapage Competition 50 2T 10-11
Malaguti	CNK Drakon 50 2T 05-07, Fifty Evolution 50 2T 90-93, XSM 50 50 2T -00, XTM 50 50 2T -00

MBK	X Limit 50 2T -00, X Power 50 2T -00
Minarelli	AM 345 Motori Minarelli 50 2T -00
Motorhispania	-Furia 50 50 2T -00, Furia Max 50 50 2T -00, RX 50 50 2T -00, RX 50 R 50 2T -00
Peugeot	Supermotard 50 2T -00, XP6 Trail S/Avv. Elettrico 50 2T -00, XR6 Racing Cat. C/avv.elett. 50 2T -00
Rieju	MRT 50 50 2T -00, MRT 50 PRO 50 2T -00, MRT 50 PRO SM 50 2T -00, MRT 50 SM 50 2T -00, MRX 50 50 2T -00, MRX 50 PRO 50 2T -00, RR 50 50 2T -00, RS1 50 50 2T -00, RS2 50 Matrix 50 2T -00, RS2 50 Matrix Pro 50 2T -00, RS2 Naked 50 50 2T -00, SMX 50 E.S./K.S. 50 2T -00, SMX 50 PRO E.S./K.S. 50 2T -00, Spike 50 50 2T -00
Sherco	HRD Enduro 50 50 2T -00, HRD Motard 50 50 2T -00
Yamaha	DT R 50 2T 03-10, DT RSM 50 2T 03-05, DT X 50 2T 06-10, TZR 50 2T 03-08, TZR 50 2T 10-11, TZR RR 50 2T 05-05



◀ cod. **AA00792**
Corpo pompa acqua per motore Minarelli AM6



◀ cod. **AA00796**
Kit revisione pompa acqua per motore scooter 50 cc Piaggio/Gilera

APPLICABILITÀ

Aprilia	SR Carburatore 50 2T 14-14, SR Motard 50 2T 12-13, SR R 50 2T 04-09, SR R FACTORY Carburatore 50 2T -, SR R FACTORY IE 50 2T-IE 10-12, SR R FACTORY IE 50 2T -, SR Street Carburatore 50 2T 03-12	Gilera	Runner SP 50 2T 02-07, Runner SP 50 2T 10-12, Runner SP ST & Simoncelli 50 2T 08-09, Runner SP Special Edition 50 2T 07-07
Derbi	GP1 50 2T 01-03, GP1 EU2 50 2T 05-05, GP1 Open EU2 50 2T 06-09, GP1 Race EU2 50 2T 05-07	Piaggio	NRG 50 2T 94-96, NRG Extreme 50 2T 99-00, NRG MC3 50 2T 01-04, NRG Power DD 50 2T 05-13, NRG Power DD Serie Speciale 50 2T -, NRG Power Pure Jet 50 2T-IE 04-05, NRG Power PureJet 50 2T-IE 06-11, NRG PureJet 50 2T-IE 02-04, NRG PureJet 50 2T-IE 10-10, NRG RST MC2 50 2T 96-98, NTT 50 2T 95-96, Quartz 50 2T 92-96, Zip 2T 50 2T -, Zip LC 50 2T 00-04, Zip Sp 50 2T 96-04, Zip Sp Euro 2 50 2T -
Gilera	DNA 50 2T 00-02, DNA 50 2T 05-07, DNA GP Experience 50 2T 03-04, Runner 50 2T 97-00, Runner Poggiali 50 2T 02-02, Runner Pure Jet 50 2T-IE 02-07, Runner Pure Jet 50 2T-IE 10-11, Runner Pure Jet ST 50 2T-IE 08-08		



◀ cod. **AA00805**
Kit revisione pompa acqua per motore scooter Minarelli/Yamaha YP 125/150/180 cc

APPLICABILITÀ

Benelli	Velvet 125 125 4T 99-01, Velvet 150 150 4T 99-01	Yamaha	Majesty 125 125 4T 98-02, Majesty 125 E 125 4T 03-09, Maxter 125 125 4T 01-02, Teo's 125 125 4T 00-00, Majesty 150 150 4T 00-02, Maxter 150 150 4T 01-02, Teo's 150 150 4T 01-02, Majesty 180 E 180 4T 03-06
Italjet	Jupiter 125 125 4T -00, Millenium 125 125 4T -00, Jupiter 150 150 4T -00, Millenium 150 150 4T -00		
Malaguti	Madison 125 125 4T 99-01, Madison R Restyling 125 125 4T 02-02, Madison R Restyling 125 EU2 125 4T 03-04, Phantom Max 125 125 4T 03-03, Madison T 150 150 4T 99-01		
Mbk	Doodo 125 125 4T 00-00, Skyliner 125 125 4T 98-02, Skyliner E 125 125 4T 03-03, Thunder 125 125 4T 01-02, Doodo 150 150 4T 01-02, Skyliner 150 150 4T 00-02, Thunder 150 150 4T 01-02, Skyliner E 180 180 4T 03-03		



◀ cod. **AA00806**
Kit revisione pompa acqua per motore scooter Minarelli/Yamaha YP 250/270 cc

APPLICABILITÀ

Aprilia	Leonardo 250 250 4T 99-04, Leonardo 250 ST 250 4T 01-01, Leonardo 300 300 4T 02-04	Mbk	Skyliner 250 250 4T 00-03, Skyliner 250 ABS 250 4T 03-03, Kilibre 300 300 4T 03-06
Benelli	Velvet 250 250 4T 99-03	Yamaha	Majesty 250 250 4T 96-03, Majesty 250 ABS 250 4T 03-03, Majesty 250 DX 250 4T 98-99, X-City 250 250 4T 07-12, X-Max 250 250 4T 05-12, Versity 300 300 4T 03-06
Italjet	Jupiter 250 250 4T 00-00		
Malaguti	Madison S 250 250 4T 99-01, Password 250 250 4T 05-06, Password 250 EU3 250 4T 07-08		



◀ cod. **AA00808**
Kit revisione pompa acqua Katana-Ditech 13 mm 2SR

APPLICABILITÀ

Suzuki	Katana 50 2T 97-04
---------------	--------------------



◀ cod. **AA00809**
Kit revisione pompa acqua Katana-Ditech 50 cc con girante a pale basse 7 mm

APPLICABILITÀ

Aprilia	SR DITECH EU2 50 2T-IE 02-03, SR H2O Carburatore 50 2T 00-03, SR H2O DITECH 50 2T-IE 00-03, SR R FACTORY Motore Aprilia 50 2T-IE 05-05
Suzuki	Katana 50 2T 01-04, Zillion 50 2T 99-99



◀ cod. **AA00810**
Kit revisione pompa acqua Aprilia Scarabeo 125/150 cc

APPLICABILITÀ

Aprilia Leonardo 125 125 4T 99-02, Leonardo ST 125 4T 03-04, Scarabeo 125 125 4T 99-03, Leonardo 150 150 4T 99-02, Scarabeo 150 150 4T 99-03
BMW C1 125 125 4T 00-03



◀ cod. **AA00811**
Kit revisione pompa acqua Aprilia Leonardo 125/150 cc

APPLICABILITÀ

Aprilia Leonardo 125 125 4T 96-98, Leonardo 150 150 4T 96-98



◀ cod. **AA00812**
Kit revisione pompa acqua Honda Pantheon 125/150 cc 2T

APPLICABILITÀ

Honda Pantheon 125 [FES] 125 2T 98-02, Pantheon 150 [FES] 150 2T 98-02



◀ cod. **AA00813**
Kit revisione pompa acqua Honda SH 125/150 cc 4T

APPLICABILITÀ

Honda @ [NES] 125 125 4T 00-06, Dylan 125 [SES] 125 4T 02-04, PS I 125 [PES] 125 4T 06-10, Pantheon 125 IE [FES] 125 4T-2V 03-05, SH 125 125 4T-2V 01-04, SH IE 125 Scoopy 125 4T-2V 05-12, Silver Wing 125 [FES] 125 4T-2V 07-12, @ [NES] 150 150 4T 00-06, Dylan 150 [SES] 150 4T 02-04, PS I 150 [PES] 150 4T 06-10, Pantheon 150 IE [FES] 150 4T-2V 03-05, SH 150 150 4T-2V 01-04, SH IE 150 Scoopy 150 4T 05-12, Silver Wing 150 [FES] 150 4T-2V 07-12



◀ cod. **AA00814**
Kit revisione pompa acqua Honda Foresight 250 cc 4T

APPLICABILITÀ

Honda Foresight 250 [FES] 250 4T 98-99



◀ cod. **AA00815**
Kit revisione pompa acqua Kymco 125/150 cc 4T

APPLICABILITÀ

Kymco B&W 125 125 4T 00-00, B&W 125 EU2 125 4T 03-04, Dink 125 125 4T 97-98, Dink Classic 125 125 4T 02-02, Dink Classic 125 EU2 125 4T 03-03, Dink LX 125 125 4T 98-00, Grand Dink 125 125 4T 01-02, Grand Dink 125 EU2 125 4T 03-04, B&W 150 150 4T 00-00, B&W 150 EU2 150 4T 03-04, Dink 150 150 4T 97-98, Dink Classic 150 150 4T 02-02, Dink Classic 150 EU2 150 4T 03-03, Dink LX 150 150 4T 98-00, Grand Dink 150 150 4T 01-02, Grand Dink 150 EU2 150 4T 03-04, Dink Classic 200 200 4T 04-04



◀ cod. **AA00816**
Kit revisione pompa acqua Kymco 250 cc 4T

APPLICABILITÀ

Kymco B&W 250 250 4T 00-00, B&W 250 EU2 250 4T 03-03, Grand Dink 250 250 4T 01-02, Grand Dink 250 EU2 250 4T 03-04, People LC 250 250 4T 03-04, People S 250 250 4T 06-06, People S 250 I 250 4T 07-07, Xciting 250 250 4T 05-05, Xciting 250 I 250 4T 06-07, Yup 250 250 4T 03-03, People S 300 I 300 4T 08-08, Xciting 300 I 300 4T 08-08, Xciting R 300i 300 4T 08-09



◀ cod. **AA00817**
Kit revisione pompa acqua Piaggio/Aprilia 125/200 cc

APPLICABILITÀ

Aprilia Atlantic 125 125 4T 03-05, Atlantic Arrecife 125 125 4T -00, Scarabeo 125 125 4T 04-06, Sportcity 125 125 4T 04-06, Scarabeo 150 150 4T 04-06, Atlantic 200 200 4T 03-05, Atlantic Arrecife 200 200 4T -00, Sportcity 200 200 4T 04-06

Gilera DNA 125 125 4T 01-01, Runner VX 125 125 4T 00-06, Runner 180 180 4T 00-01, Runner VXR 180 180 4T 00-01

Piaggio Beverly 125 125 4T 01-03, Beverly RST 125 125 4T 04-05, Carnaby 125 125 4T 07-10, Hexagon GTX 125 125 4T 00-00, Super Hexagon GTX 125 125 4T 01-02, Vespa GRAN-TURISMO 125 125 4T 03-05, X8 125 125 4T 04-04, X9 125 125 4T 01-02, X9 Evolution 125 125 4T 03-03, Hexagon GTX 180 180 4T 00-00, Super Hexagon GTX 12 180 180 4T 01-02, X9 Amalfi 180 180 4T 00-03, Beverly 200 200 4T 01-03, X8 200 200 4T 04-04, X9 200 200 4T 02-03, X9 Evolution 200 200 4T 03-03

Renault Fulltime 125 125 4T -00



◀ cod. **AA00818**
Kit revisione pompa acqua Yamaha Majesty 400cc

APPLICABILITÀ

Yamaha Maje Majesty 400 400 4T 04-08, Majesty 400 ABS 400 4T 07-08, X-MAX 400 4T-4V 15-16, X-MAX ABS 400 4T-4V 14-16, X-MAX IRONMAX ABS 400 4T-4V 16-16, X-MAX MOMODESIGN 400 4T-4V 14-14, X-MAX MOMODESIGN ABS 400 4T-4V 14-14 sty 400 400 4T 04-08, Majesty 400 ABS 400 4T 07-08



◀ cod. **AA00819**
Kit revisione pompa acqua Suzuki Burgman 125/150/200/250/400cc

APPLICABILITÀ

Suzuki Epicuro 125 125 4T 99-01, UH Burgman 125 K2/K6 125 4T 02-06, UH Burgman 125 K7/L0 125 4T 07-10, UH Burgman 125 L1 125 4T 11-11, Epicuro 150 150 4T 99-01, UH Burgman 150 K2/K6 150 4T 02-06, UH Burgman 200 K7/L0 200 4T 07-10, UH Burgman 200 L1 200 4T 11-12, AN Burgman 250 K3/K6 250 4T 03-06, AN Burgman 250 W/K2 250 4T 98-02, AN Burgman 400 K3/K6 400 4T 03-06, AN Burgman 400 X/K2 400 4T 99-02



◀ cod. **AA00820**
Kit revisione pompa acqua Yamaha T-Max '04-'11 (5vu)

APPLICABILITÀ

Yamaha T-Max 4BS 500 500 4T 09-11, T-Max 4BS ABS 500 500 4T 08-11, T-Max 5VU 500 500 4T 04-08, T-Max 5VU ABS 500 500 4T 05-07, T-Max 5VU BLACK MAX 500 4T 06-06, T-Max 5VU BLACK MAX - NIGHT MAX 500 4T 07-07



◀ cod. **AA00822**
Kit revisione pompa acqua Honda SH 300cc

APPLICABILITÀ

Honda SH IE 300 Scoopy 300 4T-4V 07-16

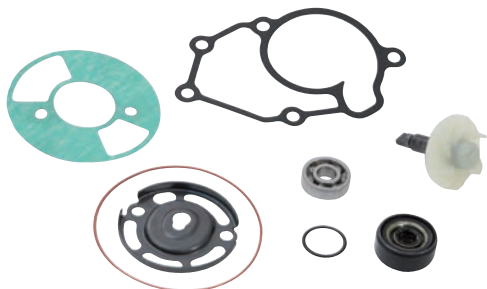

◀ cod. **AA00823**
Kit revisione pompa acqua Yamaha X-Max 125cc

APPLICABILITÀ

Mbk Cityliner 125 EU3 125 4T-4V 08-10, Skycruiser 125 125 4T-4V 07-07

Yamaha X-City 125 EU3 125 4T-4V 08-11, X-Max R 125 125 4T-4V 06-16, X-Max R 125 ABS 125 4T-4V 11-11, X-Max RA 125 ABS 125 4T-4V 13-16



◀ cod. **AA00824**
Kit revisione pompa acqua Piaggio 500cc Euro3

APPLICABILITÀ

Aprilia Scarabeo Light 400 400 4T 06-08, Scarabeo Light 500 500 4T 06-08

Gilera Fuoco 500 IE EU3 500 4T 07-13, Nexus 500 EU3 500 4T 06-08

Piaggio Beverly 400 EU3 400 4T 06-07, Beverly Tourer 400 EU3 400 4T 08-10, MP3 400 400 4T 07-08, MP3 400 IE LT Touring 400 4T 11-11, MP3 400 IE LT/Sport 400 4T 08-10, MP3 400 MIC 400 4T 08-10, MP3 400 RL Touring 400 4T 11-11, X-Evo 400 400 4T 07-11, Beverly 500 ie EU3 500 4T 06-08, Beverly Cruiser 500 500 4T 07-11, MP3 500 LT Sport/Business 500 4T -, MP3 500 RL Sport 500 4T -



◀ cod. **AA00825**
Kit revisione pompa acqua Derbi d50b0 (motore Piaggio)

APPLICABILITÀ

Aprilia RS 50 50 2T 06-10, RS4 50 2T 11-13, RX 50 50 2T 06-, SX 50 2T 06-10, SX 50 50 2T -

Derbi GPR 2T EU2 50 2T 09-10, GPR NUDE & GPR NUDE Tuning 50 2T 06-08, GPR NUDE Sport 50 2T 06-06, GPR R EU2 - GPR Replica EU2 50 2T 08-08, GPR Racing EU2 50 2T 06-06, GPR Replica & GPR R EU2 50 2T 06-06, GPR Replica 2T Malossi 50 2T 07-07, GPR Replica Pesek EU2 50 2T 07-07, Senda HYP DRD Evo EU2 50 2T 08-09, Senda HYP DRD Evo Limited Edition EU2 50 2T 08-08, Senda R DRD PRO EU2 50 2T 05-11, Senda R DRD Racing EU2 50 2T 05-08, Senda

Derbi R X-RACE 2T EU2 50 2T 10-10, Senda R X-RACE EU2 50 2T 06-09, Senda R X-TREME 2T EU2 50 2T -, Senda R X-TREME EU2 50 2T 05-08, Senda SM DRD PRO EU2 50 2T 05-11, Senda SM DRD Racing EU2 50 2T 05-08, Senda SM DRD Racing LTD EU2 50 2T 07-07, Senda SM X-RACE 2T EU2 50 2T 10-10, Senda SM X-RACE EU2 50 2T 06-09, Senda SM X-TREME 2T EU2 50 2T 10-10, Senda SM X-TREME EU2 50 2T 05-08

Gilera RCR 50 2T 06-07, RCR 50 2T 11-12, SMT 50 2T -, SMT Racing 50 2T 11-12

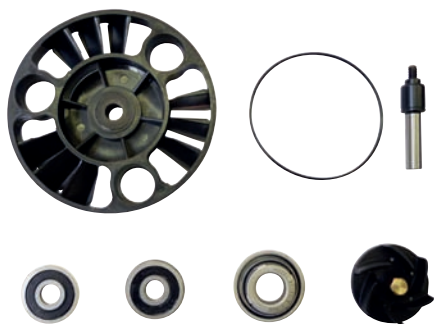

◀ cod. **AA00826**
Kit revisione pompa acqua Piaggio/Aprilia 125/200 cc Euro3

APPLICABILITÀ

Aprilia Atlantic 125 EU3 125 4T 06-08, Atlantic 125 EU3 125 4T 10-12, Scarabeo EU3 125 125 4T 06-07, Sport City Street 125 125 4T 12-12, Sportcity 125 EU3 125 4T 06-08, Sportcity Cube 125 125 4T 08-10

Derbi GP1 125 EU 2 125 4T 06-06, GP1 Low Seat EU3 125 4T 07-08, Rambla 125 125 4T 08-09, Rambla 125 EU3 2VER 125 4T 08-08

Gilera Nexus 125 EU3 125 4T 07-08, Runner 4T ST EU3 125 125 4T 08-13, Runner VX 4T EU3 125 125 4T 06-07, Runner VX Race 125 125 4T 06-06, Runner VX SC 125 4T 06-07, Runner VXR 200 200 4T 02-06, Runner VXR 4T ST EU3 200 200 4T 08-11, Runner VXR EU3 200 200 4T 07-07

Piaggio Beverly 125 EU3 125 4T 07-08, Beverly 125 EURO 3 MIC 125 4T 07-07, Beverly 125 EURO 3 SPORT 125 4T 07-08, Beverly 125 RST 4T 4V IE EU3 125 4T 10-15, Beverly 125 Tourer EU3 125 4T 07-10, Beverly RST 125 125 4T 05-07, MP3 125 125 4T 06-08, Vespa GRANTURISMO 125 125 4T 06-07, Vespa GRANTURISMO 125 EU3 125 4T 06-07, Vespa GTS 125 EU3 125 4T 07-12, Vespa GTV 125 125 4T 06-08, Vespa GTV 4T NAVY EU3 125 125 4T 08-08, X-Evo 125 125 4T 07-16, X7 125 EU3 125 4T 08-08, X8 125 125 4T 05-06, X8 125 Premium EU2 125 4T 06-06, X8 125 Premium EU3 125 4T 06-07, X9 Evolution 125 125 4T 05-06, X9 Evolution EU3 125 125 4T 07-07, Carnaby 200 200 4T 07-08, Vespa GRANTURISMO 200 200 4T 06-07, X8 200 200 4T 05-07

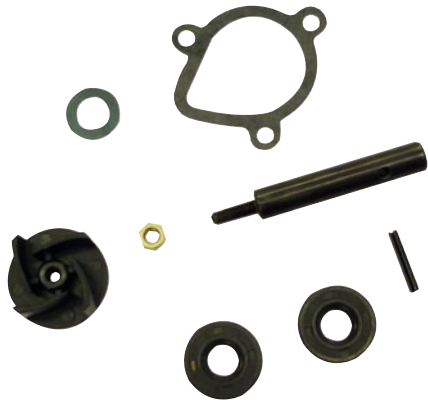

◀ cod. **AA00827**
Kit revisione pompa acqua Derbi ebs050 (vecchio modello)

APPLICABILITÀ

Derbi Bultaco Lobito 50 2T 98-01, GPR NUDE 50 2T 04-05, GPR R 50 2T 97-00, GPR Racing 50 2T 04-05, GPR Replica 50 2T 99-01, GPR Replica Racing 50 2T 02-03, GPR Replica Racing EU2 50 2T 05-05, Sebda R Racer 50 2T 03-03, Senda Black Edition 50 2T 03-03, Senda R 50 2T 99-01, Senda R DRD EU1 EU1R 50 2T 02-02, Senda R DRD Racing 50 2T 04-05, Senda R DRD Racing LTD 50 2T 05-05, Senda R X-RACE 50 2T 04-05, Senda R X-TREME 50 2T 03-03, Senda R X-TREME 50 2T 05-05, Senda R X-TREME EU2 50 2T 04-04, Senda SM 50 2T 00-01, Senda SM DRD EU1 EU1R 50 2T 02-03, Senda SM DRD Edition Black 50 2T 05-05, Senda SM DRD Racing 50 2T 04-05, Senda SM DRD Racing LTD 50 2T 05-05, Senda SM X-RACE 50 2T 04-05, Senda SM X-TREME 50 2T 02-03, Senda SM X-TREME EU2 50 2T 04-04

Gilera Gsm H@K 50 2T 01-01, RCR 50 2T 03-03, SMT 50 2T 03-03

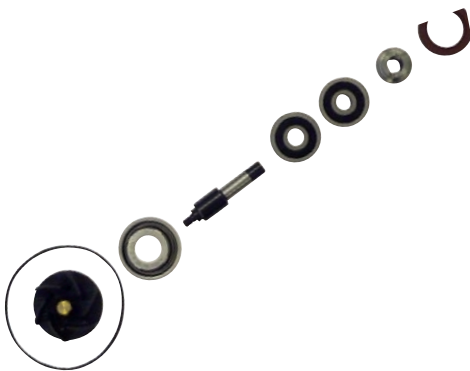

◀ cod. **AA00828**
Kit revisione pompa acqua Piaggio 300cc

APPLICABILITÀ

Aprilia Atlantic 250 250 4T 03-05, Atlantic 250 EU3 250 4T 06-08, Scarabeo 250 250 4T 04-06, Scarabeo Light 250 250 4T 06-08, Atlantic 300 300 4T 10-11, SR MAX 300 300 4T 11-14, Scarabeo Light 300 300 4T 09-10, Sprot City Street 300 300 4T-4V 12-12

Derbi Rambla 250 250 4T 08-09, Rambla 250 EU3 2VER 250 4T 08-08, Rambla 300 300 4T 10-11

Gilera Nexus 250 EU3 250 4T 06-07, Nexus SP 250 EU3 250 4T 06-07, Oregon 250 250 4T 06-10, Nexus 300 EU3 300 4T 08-11

Piaggio Beverly 250 250 4T 06-07, Beverly 250 CRUISER 250 4T 07-09, Beverly 250 EURO 3 MIC 250 4T 07-07, Beverly 250 SPORT 250 4T 06-08, Beverly 250 Tourer EU3 250 4T 07-09, Beverly 250 ie EU3 250 4T 06-08, Carnaby 250 250 4T 08-08, MP3 250 250 4T 06-08, MP3 250 LT 250 4T 08-09, MP3 250 MIC 250 4T 08-09, Vespa GT 60 250 EU3 250 4T 06-07, Vespa GTS 250 250 4T 05-16, Vespa GTS ABS 250 250 4T 05-12, Vespa GTV 250 250 4T 06-09, Vespa GTV 4T NAVY EU3 250 250 4T 07-07, X-Evo 250 250 4T 07-16, X7 250 EU3 250 4T 08-08, X8 250 EU3 250 4T 05-08, X9 Evolution 250 250 4T 06-06, Beverly 300 RST 4T 4V IE EU3 300 4T 10-15, Beverly Tourer 300 EU3 300 4T 09-10, Carnaby Cruiser 300 300 4T 09-12, MP3 300 4T 4V IE LT Ibrido 300 4T 10-11, MP3 300 IE LT 300 4T 10-11, MP3 300 IE LT Touring 300 4T 11-13, MP3 300 IE LT/Sport 300 4T 11-14, MP3 300 IE MIC 300 4T 10-11, MP3 300 IE Touring 300 4T 11-12, MP3 300 Yourban ERL 300 4T 11-15, MP3 300 Yourban LT ERL 300 4T 11-12, Vespa GTS IE Touring 300 300 4T 11-12, Vespa GTS Super 300 4T 08-15, Vespa GTS Super Sport 300 4T 10-13, Vespa GTV 4T 4V IE 300 300 4T 10-13, Vespa GTV VIA MONTENAPOLEONE 300 4T 10-10, X7 Evo 300 IE EU3 300 4T 09-10



◀ cod. **AA00829**
Kit revisione pompa acqua Piaggio Beverly 350 cc

APPLICABILITÀ

Piaggio Beverly 350 4T 4V IE EU3 350 4T 11-13

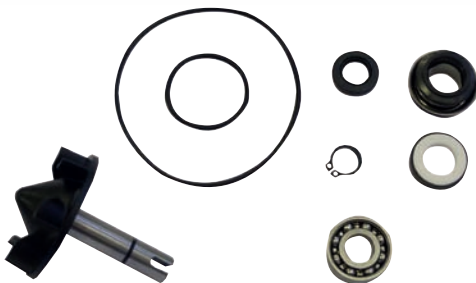

◀ cod. **AA00831**
Kit revisione pompa acqua Yamaha T-Max 530cc

APPLICABILITÀ

Yamaha T-Max 59C 530 530 4T 12-16, T-Max 59C 530 ABS 530 4T 12-16, T-Max 59C 530 SP 530 4T 15-15, T-Max 59C 530 SP ABS 530 4T 15-16



◀ cod. **AA00832**
Kit Revisione Pompa Acqua Yamaha Xenter 125/150cc

APPLICABILITÀ

Yamaha Xenter 125 125 4T 12-16, Xenter 150 150 4T 12-16

KIT REVISIONE POMPA ACQUA



◀ **cod. AA00833**
Kit Revisione Pompa Acqua Kymco Downtown 300cc

APPLICABILITÀ

Kymco Downtown I 200 200 4T 10-10, People GTI 200 200 4T 10-10, Downtown 300I 300 4T 09-09, Downtown ABS 300 300 4T 10-10, Downtown I 300 300 4T 11-11, Downtown I ABS 300 300 4T 11-11, People GTI 300 300 4T 10-11

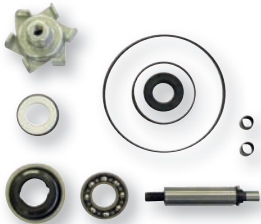

◀ **cod. AA00834**
Kit Revisione Pompa Acqua Honda PCX 125cc

APPLICABILITÀ

Honda PCX 125 125 4T-2V 10-13, SH 125 i ABS 125 4T-2V 13-16, SH 150 i ABS 125 4T-2V 13-16



◀ **cod. AA00835**
Kit Revisione Pompa Acqua Kymco Downtown 125cc

APPLICABILITÀ

Kymco Downtown 125 I 125 4T 09-09



◀ **cod. AA00836**
Kit Revisione Pompa Acqua Honda Silver Wing 400/600cc

APPLICABILITÀ

Honda SW-T 400 [FJS] 400 4T 09-13, Silver Wing 400 [FJS] 400 4T 06-08, SW-T 600 [FJS] 600 4T 11-13, Silver Wing 600 [FJS] 600 4T 01-10

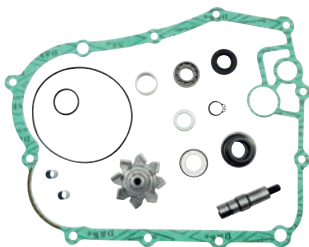

◀ **cod. AA00837**
Kit Revisione Pompa H2O Kymco Xciting 400cc

APPLICABILITÀ

Kymco Xciting 400 I 400 4T 13-13, Xciting 400 I 400 4T 15-15, Xciting 400 I ABS 400 4T 14-15

POMPA ACQUA



◀ **cod. AA00838**
Pompa Acqua Completa Yamaha YP 250/270cc

APPLICABILITÀ

Aprilia Leonardo 250 250 4T 99-04, Leonardo 250 ST 250 4T 01-01, Leonardo 300 300 4T 02-04
Benelli Velvet 250 250 4T 99-03
Italjet Jupiter 250 250 4T 00-00
Malaguti Madison S 250 250 4T 99-01, Password 250 250 4T 05-06, Password 250 EU3 250 4T 07-08

Mbk Skyliner 250 250 4T 00-03, Skyliner 250 ABS 250 4T 03-03, Kilibre 300 300 4T 03-06
Yamaha Majesty 250 250 4T 96-03, Majesty 250 ABS 250 4T 03-03, Majesty 250 DX 250 4T 98-99, X-City 250 250 4T 07-12, X-Max 250 250 4T 05-12, Versity 300 300 4T 03-06

POMPE BENZINA



- ◀ **cod. PB00900**
Pompa Benzina Yamaha T-Max 500/530 Suzuki Burgman 125/200cc

APPLICABILITÀ

Suzuki UH Burgman 125 K7/LO 125 4T 07-10, UH Burgman 125 L1 125 4T 11-11, UX Sixteen 125 K8/LO 125 4T 08-10, UX Sixteen 125 L1 125 4T 11-11, UX Sixteen 150 K8/LO 150 4T 08-10, UX Sixteen 150 L1 150 4T 11-11, UH Burgman 200 K7/LO 200 4T 07-10, UH Burgman 200 L1 200 4T 11-12

Yamaha X-Max R 125 125 4T-4V 06-14, X-Max R 125 ABS 125 4T-4V 11-11, X-Max RA 125 ABS 125 4T-4V 14-15, X-Max 250 250 4T 07-14, X-Max 250 ABS 250 4T 11-14, X-Max 250 Black 250 4T 09-09, X-Max 250 Sport 250 4T 11-12, Majesty 400 400 4T 04-11, Majesty 400 ABS 400 4T 07-11, T-Max 4B5 500 500 4T 09-11, T-Max 4B5 ABS 500 500 4T 08-11, T-Max 5VU 500 500 4T 04-08, T-Max 5VU ABS 500 500 4T 05-07, T-Max 5VU BLACK MAX 500 4T 06-06, T-Max 5VU BLACK MAX - NIGHT MAX 500 4T 07-07, T-Max SV 500 4T 11-11, T-Max SV ABS 500 4T 11-11, T-Max White Max 500 4T 10-10, T-Max 59C 530 530 4T 12-16, T-Max 59C 530 ABS 530 4T 12-16, T-Max 59C 530 SP 530 4T 15-15, T-Max 59C 530 SP ABS 530 4T 15-16



- ◀ **cod. PB00901**
Pompa Benzina Honda SH 125/150/300cc

APPLICABILITÀ

Honda SH IE 125 Scoopy 125 4T-2V 05-12, SH IE 150 Scoopy 150 4T 05-12, SH IE 300 Scoopy 300 4T-4V 07-16



- ◀ **cod. PB00902**
Kit Pompa Benzina Scooter Piaggio 125/250/300cc

APPLICABILITÀ

Aprilia Scarabeo Light 250 250 4T 06-08, Sportcity Cube 250 250 4T 08-12, Sprot City Street 300 300 4T-4V 12-12

Piaggio Vespa GTS 4T IE SUPER 125 4T 09-16, Beverly 250 SPORT 250 4T 06-08, Beverly 250 ie EU3 250 4T 06-08, Vespa GTS IE Touring 300 300 4T 11-12, Vespa GTS Super 300 4T 08-15, Vespa GTS Super Sport 300 4T 10-13, Vespa GTV 4T 4V IE 300 300 4T 10-13, Vespa GTV VIA MONTENAPOLEONE 300 4T 10-10



- ◀ **cod. PB00903**
Kit Pompa Benzina Piaggio 500cc

APPLICABILITÀ

Aprilia Scarabeo Light 400 400 4T 06-08, Scarabeo Light 500 500 4T 06-08

Piaggio Beverly 500 500 4T 02-06

Malaguti Spider Max 500 GT 500 4T 04-05, Spider Max 500 GT EU3 500 4T 06-06, Spider Max RS 500 500 4T 08-08



- ◀ **cod. PB00904**
Pompa Benzina Suzuki Burgman 400cc K7

APPLICABILITÀ

Suzuki AN Burgman 400 K7/LO 400 4T 07-10, AN Burgman 400 L1 400 4T 11-11, AN Burgman L2 400 4T 12-12, AN Burgman L3 400 4T 13-13, AN Burgman L4 400 4T 14-14, AN Burgman L5 400 4T 15-15, AN Burgman L6 400 4T 16-16



- ◀ **cod. PB00905**
Kit Pompa Benzina BMW R1200GS

APPLICABILITÀ

BMW R 1200 GS (K25) 1200 4T 02-09, R 1200 GS Adventure (K25) 1200 4T 05-13, R 1200 RT (K26) 1200 4T 03-14, K 1300 GT (K44) 1300 4T 04-10

GABBIA / MOLLE / SCODELLINO



- ◀ **cod. AA00767**
Gabbia a rulli per ruota libera 57x61x10 per motore scooter 50 cc Minarelli/Yamaha



- ◀ **cod. AA00768**
Molla per scorrevole messa in moto per motore scooter 50 cc Minarelli/Yamaha



- ◀ **cod. AA00800**
Scodellino dentato per motore scooter 50 cc Gilera/Piaggio



◀ cod. **AM00001**
Albero primario nudo per AM6 1° serie



◀ cod. **AM00002**
Albero secondario nudo per AM6 1° serie



◀ cod. **AM00003**
Albero selettore per AM6



◀ cod. **AM00004**
Raccordo entrata pompa acqua per AM6



◀ cod. **AM00005**
Tappo alimentazione olio per AM6



◀ cod. **AM00006**
Ingranaggio 2a velocità su primario Z=16 per AM6 1° serie



◀ cod. **AM00007**
Ingranaggio 3a-4a velocità su primario Z=19-22 adat. AM6 1° serie



◀ cod. **AM00008**
Ingranaggio 5a velocità su primario Z=24 per AM6 1° serie



◀ cod. **AM00009**
Ingranaggio 6a velocità su primario Z=25 per AM6 1° serie



◀ cod. **AM00010**
Ingranaggio 1a velocità su secondario Z=36 per AM6 1° serie



◀ cod. **AM00011**
Ingranaggio 2a velocità su secondario Z=33 per AM6 1° serie



◀ cod. **AM00012**
Ingranaggio 3a velocità su secondario Z=29 per AM6 1° serie



◀ cod. **AM00013**
Ingranaggio 4a velocità su secondario Z=27 per AM6 1° serie



◀ cod. **AM00014**
Ingranaggio 5a velocità su secondario Z=25 per AM6 1° serie



◀ cod. **AM00015**
Ingranaggio 6a velocità su secondario Z=24 per AM6 1° serie



◀ cod. **AM00016**
Ingranaggio doppio intermedio Z=13-24 per AM6 1° serie



◀ cod. **AM00017**
Leva frizione completa per AM



◀ cod. **AM00018**
Chiavetta per pignone motore AM



◀ cod. **AM00019**
Chiavetta per volano motore AM



◀ cod. **AM00020**
Astuccio a rulli DB 14-12



◀ cod. **AM00021**
OR 11,8x2,4



◀ cod. **AM00022**
Guarnizioni coperchio frizione per AM



◀ cod. **AM00023**
Guarnizioni corpo pompa acqua per AM



◀ cod. **AM00024**
Paraolio 10x18x8



◀ cod. **AM00025**
Girante con perno per pompa acqua AM



◀ cod. **AM00026**
Interruttore spia folle per AM



◀ cod. **AM00027**
Rullo per ingranaggio condotto pompa per AM



◀ cod. **AM00028**
Rullo riferimento corpo pompa per AM



◀ cod. **BA00006**
Blocco accensione e serratura MBK Nitro



◀ cod. **BA00007**
Blocco accensione e serratura MBK Booster Stunt



◀ cod. **BA00012**
Blocco accensione e serratura Malaguti F12



◀ cod. **BA00014**
Blocco accensione e serratura Kymco Agility 50 cc



◀ cod. **BD00001**
Bobina A.T. scooter 50 cc Minarelli/Yamaha con volano giapponese

RIFERIMENTO ORIGINALE

Ducati	432261000
--------	-----------



cod. **B000001**

Bobina A.T. per Kymco Agility

RIFERIMENTO ORIGINALE

Kymco	00168770
Kymco	00168585
Kymco	00169202

Kymco	00169400
Malaguti	02412700
Piaggio	58083R

APPLICABILITÀ

Aprilia Sport City Street 125 125 4T 12-12, Sportcity One 4T EU3 125 125 4T 08-11

Derbi Boulevard 125 125 4T 03-04, Boulevard 125 EU3 125 4T 04-07, Boulevard 4T EU3 125 4T 08-12, GP1 125 EU 2 125 4T 06-06, Boulevard 150 150 4T 03-04, Boulevard 150 EU3 150 4T 04-07, Boulevard 4T E3 150 4T 10-10, Boulevard 200 EU2 200 4T 05-06, GP1 250 250 4T 06-07, GP1 250 Low Seat EU3 250 4T 07-08

Gilera Nexus 125 EU3 125 4T 07-08, Runner 4T ST EU3 125 125 4T 08-13, Runner VX 125 125 4T 05-06, Runner VX 4T EU3 125 125 4T 06-07, Runner VXR 4T ST EU3 200 200 4T 08-11, Runner VXR EU3 200 200 4T 07-07, Oregon 250 250 4T 06-10

Kymco Agility 4T Carry 50 4T 11-11, Agility 4T R10 50 4T 06-08, Agility 4T R12 50 4T 07-08, Agility R12 50 4T 05-05, Agility RS 50 4T 09-09, Bet & Win 50 2T 02-02, Bet & Win EU2 50 2T 03-03, Dink LC 50 2T 98-02, Filly LX 50 4T 01-02, Like 50 4T 09-09, Mxer 50 50 2T 02-03, Mxer EU2 50 50 2T 04-04, People S 50 2T 05-08, Sniper 50 2T 93-93, Sniper DD 50 2T 94-96, Super 9 50 2T 00-00, Super 9 EU2 50 2T 03-04, Vitality 4T 50 4T 04-04, Agility 125 125 4T 06-06, Agility 125 EU3 125 4T 06-08, Agility 125 R16 125 4T 08-09, Agility 125 RS 125 4T 09-09, Heroism 125 125 4T 95-97,

Like 125 125 4T 09-09, Movie 125 125 4T 99-00, Movie 125 EU3 125 4T 06-07, Movie XL 125 125 4T 01-01, Movie XL 125 125 4T 03-04, Super 8 125 125 4T 08-09, Vivio 125 125 4T 00-00, Agility 150 R16 150 4T 08-09, Heroism 150 150 4T 95-97, Movie 150 EU3 150 4T 06-07, Movie XL 150 150 4T 01-01, Movie XL 150 EU2 150 4T 03-04, Vivio 150 150 4T 00-00, Like LX 200 4T 12-12

Malaguti Ciak Master EU3 125 125 4T 06-06, Ciak Master 200 EU2 200 4T 06-06

Piaggio Fly 125 125 4T 05-07, Fly 125 EU3 125 4T 07-11, MP3 125 125 4T 06-08, Skypper 125 4T 125 4T 00-02, Typhoon 125 4T 2V E3 125 4T 10-11, X-Evo 125 125 4T 07-16, X7 125 EU3 125 4T 08-08, X8 125 125 4T 04-06, X8 125 Premium EU2 125 4T 06-06, X8 125 Premium EU3 125 4T 06-07, X8 Street 125 EU2 125 4T 06-07, X9 125 125 4T 01-02, X9 Evolution 125 125 4T 03-03, X9 Evolution 125 125 4T 05-06, X9 Evolution EU3 125 125 4T 07-07, Zip 125 125 4T 00-02, Fly 150 150 4T 05-07, Fly 150 EU3 150 4T 08-11, X8 Street 150 EU2 150 4T 06-08, X9 Amalfi 180 180 4T 00-03, X8 200 200 4T 05-07, X9 200 200 4T 02-03, X9 Evolution 200 200 4T 03-03, X9 Evolution 250 250 4T 04-04, X9 Evolution 250 250 4T 06-06



cod. **B000002**

Bobina A.T. per Booster R - Ovetto - Majesty 125/150 dal 2000

RIFERIMENTO ORIGINALE

Yamaha	3KJ823101000
--------	--------------

APPLICABILITÀ

Mbk Booster 50 2T -00, Booster NG 50 2T 03-00, Booster Rocket 50 2T 97-98, Booster Spirit 50 2T 03-00, Booster Track 50 2T 96-98, Evolis 50 2T 92-95, Fizz 50 2T 94-95, Flipper 50 2T -00, Flipper Euro 2 50 2T 03-03, Forte 50 2T 94-96, Nitro 50 2T -00, Nitro Euro 2 50 2T 03-03, Ovetto 50 2T -00, Ovetto Euro 2 50 2T 02-02, Stunt 50 2T 00-02, Nitro 100 100 2T 00-02, Ovetto 100 100 2T 99-02, Doodo 125 125 4T 00-00, Skyliner 125 125 4T 98-00, Skyliner 150 150 4T 00-00

Yamaha Aerox 50 2T -00, Aerox Euro 2 50 2T 03-03, Axis 50 2T 95-96, BWS 50 2T -00, BWS Bump 50 2T 97-98, BWS Euro 2 50 2T 03-03, BWS NG 50 2T -00, BWS NG Euro 2 50 2T 03-03, Breeze 50 2T 94-95, DT R 50 2T 07-10, DT X 50 2T 07-10, Neo's 50 2T -00, Neo's Euro 2 50 2T 02-02, Slider 50 2T 00-02, Why 50 2T -00, Why Euro 2 50 2T 03-03, Aerox 100 100 2T 00-02, Neo's 100 100 2T 99-02, Majesty 125 125 4T 98-00, Teo's 125 125 4T 00-00, Majesty 150 150 4T 00-00



cod. **B000003**

Bobina A.T. Piaggio Liberty 125/150cc

RIFERIMENTO ORIGINALE

Piaggio	82597R
---------	--------

APPLICABILITÀ

Aprilia Atlantic 125 125 4T 03-05, Atlantic 125 EU3 125 4T 06-08, Atlantic 125 EU3 125 4T 10-12, Mojito 125 125 4T 03-08, SR MAX 125 125 4T 11-14, Scarabeo 125 125 4T 03-06, Sportcity 125 125 4T 04-06, Sportcity 125 EU3 125 4T 06-08, Sportcity Cube 125 125 4T 08-10, Sportcity Cube 250 250 4T 08-12, Atlantic 300 300 4T 10-11, SR MAX 300 300 4T 11-14, Sprot City Street 300 300 4T 12-12, Atlantic Sprint 400 400 4T 05-08, Scarabeo Light 400 400 4T 06-08, Atlantic Sprint 500 500 4T 05-08, Scarabeo Light 500 500 4T 06-08

Derbi GP1 Low Seat EU3 125 4T 07-08, Rambla 125 125 4T 08-09, Rambla 125 EU3 2VER 125 4T 08-08, Sonar 4T 125 125 4T 09-11, Sonar 4T 150 150 4T 09-09, Rambla 300 300 4T 10-11

Gilera DNA 125 125 4T 01-01, Nexus 125 IE EU3 125 4T 08-10, Runner VX 125 125 4T 00-04, Runner VX Race 125 125 4T 06-06, Runner VX SC 125 4T 06-07, Runner VXR Race 200 125 4T 06-06, DNA 180 180 4T 01-01, Runner VXR 200 200 4T 02-06, Nexus 250 EU3 250 4T 06-07, Nexus SP 250 EU3 250 4T 06-07, Nexus 300 EU3 300 4T 08-11, Fuoco 4T 4V IE E3 LT 500 4T 13-13, Fuoco 500 IE EU3 500 4T 07-13, Nexus 500 500 4T 03-05, Nexus 500 EU3 500 4T 06-11, Nexus SP 500 EU3 500 4T 06-07

Vespa ET4 125 125 4T 96-02, Vespa GRANTURISMO 125 125 4T 03-07, Vespa GRANTURISMO 125 EU3 125 4T 06-07, Vespa GTS 125 EU3 125 4T 07-12, Vespa GTV 125 125 4T 06-08, Vespa GTV 4T NAVY EU3 125 125 4T 08-08, Vespa LX 125 125 4T 05-06, Vespa LX 4T FL 125 4T 09-09, Vespa LX EU3 125 4T 06-08, Vespa LXV 4T EU3 125 4T 06-09, Vespa LXV NAVY EU3 125 4T 07-08, Vespa S 4T 125 EU3 125 4T 07-08, Liberty 150 150 4T 01-02, Liberty 150 4T EU3 150 4T 08-08, Liberty 150 4T Sport EU3 150 4T 08-08, Liberty 150 Moc 4T 150 4T 09-13, Vespa LX 150 150 4T 05-06, Vespa LX 4T FL 150 4T 09-09, Vespa LX EU3 150 4T 06-08, Super Hexagon GTX 12 180 180 4T 01-02, Carnaby 200 200 4T 07-08, Liberty 200 200 4T 06-06, Liberty 200 4T EU3 200 4T 06-08, Liberty 200 4T Sport EU3 200 4T 06-07, Liberty 200 Sport 200 4T 06-06, Liberty RST 200 200 4T 04-04, Vespa GRANTURISMO 200 200 4T 06-07, Beverly 250 250 4T 06-07, Beverly 250 CRUISER 250 4T 07-09, Beverly 250 EURO 3 MIC 250 4T 07-07, Beverly 250 SPORT 250 4T 06-08, Beverly 250 Tourer EU3 250 4T 07-09, Beverly 250 ie EU3 250 4T 06-08, Beverly RST 250 250 4T 04-05, Carnaby 250 250 4T 08-08, MP3 250 250 4T 06-08, MP3 250 LT 250 4T 08-09, MP3 250 MIC 250 4T 08-09, Vespa GT 60 250 EU3 250 4T 06-07, Vespa GTS 250 250 4T 05-16, Vespa GTS ABS 250 250 4T 05-12, Vespa GTV 250 250 4T 06-09, Vespa GTV 4T NAVY EU3 250 250 4T 07-07, X-Evo 250 250 4T 07-16, X7 250 EU3 250 4T 08-08, X8 250 EU3 250 4T 05-08, Beverly Tourer 300 EU3 300 4T 09-10, Beverly 400 EU3 400 4T 06-07, Beverly Tourer 400 EU3 400 4T 08-10, MP3 400 400 4T 07-08, MP3 400 IE LT Touring 400 4T 11-11, MP3 400 IE LT Sport 400 4T 08-10, MP3 400 MIC 400 4T 08-10, MP3 400 RL Touring 400 4T 11-11, X-Evo 400 400 4T 07-11, X8 400 EU3 400 4T 06-08, Beverly 500 500 4T 02-06, Beverly 500 ie EU3 500 4T 06-08, MP3 500 LT Sport/Business 500 4T - MP3 500 RL Sport 500 4T -, MP3 LT Business ABS 500 4T 14-14, MP3 Sport ABS 500 4T 14-14, X9 500 500 4T 01-02, X9 Evolution 500 500 4T 03-07, X9 Evolution ABS 500 500 4T 06-07



◀ cod. **CA00001**
Centralina accensione Vespa 50 PK

RIFERIMENTO ORIGINALE

Piaggio	610324M
---------	---------

APPLICABILITÀ

Piaggio Ciao EU1 50 2T 99-01, Ciao EU2 50 2T 02-04, Ciao Mix Teen 50 2T 96-01, Ciao TRE 50 2T 71-99, Si 50 2T 79-88, Si FL2 50 2T 91-97, Si MIX 50 2T 96-99, Vespa PK 50 2T 82-84, Vespa PK XL 50 2T 85-88, Vespa PK XL RUSH 50 2T 88-89



◀ cod. **CA00002**
Centralina accensione Vespa PX 125-150-200; ET3-PK 125

RIFERIMENTO ORIGINALE

Piaggio	244128
---------	--------

APPLICABILITÀ

Piaggio Ape 50 TM P 50 2T 85-89, Ape EU2 50 2T 03-10, Ape FL - FL2 50 2T 89-95, Ape FL3 50 2T 96-99, Ape RST MIX 50 2T 99-03, Vespa 50 2T 67-82, Vespa FL 50 2T 90-90, Vespa FL2 AUTOMATICA 50 2T 90-91, Vespa FL2 HP 50 2T 91-97, Vespa N 50 2T 89-90, Vespa PK AUTOMATICA 50 2T 84-89, Vespa PK XL PLURIMATIC 50 2T 85-90, Cosa 2 125 2T 91-97, Cosa CL, CLX 125 2T 88-91, Vespa 125 ET3 125 2T 76-83, Vespa 125 Primavera 125 2T 67-83, Vespa FL 125 2T 89-90, Vespa PK 125 2T 82-84, Vespa PK XL 125 2T 86-89, Vespa PX 125 2T 98-01, Vespa PX 125 2T 11-16, Vespa PX 125 EU2 125 2T 01-07, Vespa PX 30 Anni 125 2T 07-08, Vespa PX E 125 Arcobaleno 125 2T 81-97, Vespa PX TS 125 2T 85-89, Cosa 2 150 2T 91-97, Cosa CL, CLX 150 2T 88-91, Vespa PX 150 150 2T 98-01, Vespa PX 150 150 2T 11-16, Vespa PX E 150 Arcobaleno 150 2T 81-97, Vespa PX 200 200 2T 98-01, Vespa PX E 200 Arcobaleno 200 2T 81-97



◀ cod. **CA00003**
Centralina accensione per Booster - Nitro

RIFERIMENTO ORIGINALE

Yamaha	3KJH55400000
--------	--------------

APPLICABILITÀ

Mbk Booster 50 2T -00, Booster NG 50 2T -00, Booster Rocket 50 2T 97-98, Booster Spirit 50 2T -00, Booster Track 50 2T 96-98, Flipper 50 2T -00, Forte 50 2T 94-96, Nitro 50 2T -00, Ovetto 50 2T -00

Yamaha Aerox 50 2T -00, Axis 50 2T 95-96, BWS 50 2T -00, BWS Bump 50 2T 97-98, BWS NG 50 2T -00, Neo's 50 2T -00, Slider 50 2T 00-02, Spy 50 2T 95-98, Why 50 2T -00



◀ cod. **CA00004**
Centralina accensione per People 50 E2 2T - People S 50 2T

RIFERIMENTO ORIGINALE

Kymco	00169303
-------	----------

APPLICABILITÀ

Kymco MXU 50 50 2T 06-07, MXU SR 50 50 2T 06-06, People 50 2T 99-04, People Euro 2 50 2T 03-03, People Euro 2 50 2T 08-08, People Euro 2 50 2T 11-11, People S 50 2T 05-08



◀ cod. **CA00005**
Centralina accensione per Piaggio Sfera - Zip - Liberty '01 - Gilera Typhon

RIFERIMENTO ORIGINALE

Piaggio	638678
---------	--------

APPLICABILITÀ

Gilera Easy Moving 50 2T 95-96, Runner 50 2T 97-00, Stalker 50 2T 97-04, Storm 50 2T 94-95, Typhoon 50 2T 94-97, Typhoon X 50 2T 98-99, Typhoon XR 50 2T 00-00

Piaggio Free 50 2T 92-94, Free Delivery 50 2T 00-01, Free FL 50 2T 95-02, Liberty 50 2T 97-05, Liberty 2T PTT EU2 50 2T 04-05, NRG 50 2T 94-96, NRG Extreme 50 2T 99-00, NRG MC3 50 2T 01-04, NRG RST MC2 50 2T 96-98, NTT 50 2T 95-96, Quartz 50 2T 92-96, Sfera 50 2T 91-93, Sfera Maquillage 2 50 2T 94-94, Sfera RST 50 2T 95-97, Vespa ET2 50 2T 97-05, Zip 50 2T 92-93, Zip 50 2T 95-96, Zip Bimodale 50 2T 94-97, Zip Fast Rider 50 2T 93-94, Zip Fast Rider RST 50 2T 96-97, Zip RST 50 2T 96-99, Zip Sp 50 2T 96-00



◀ cod. **CA00006**
Centralina accensione per Kymco Agility 4T R10/R12

RIFERIMENTO ORIGINALE

Kymco	00169187
-------	----------

APPLICABILITÀ

Kymco Agility 4T Carry 50 4T 11-11, Agility 4T R10 50 4T 06-08, Agility 4T R12 50 4T 07-08, Agility R12 50 4T 05-05, Vitality 4T 50 4T 04-04



◀ cod. **CA00007**
Centralina accensione per Kymco Agility 4T R16

RIFERIMENTO ORIGINALE

Kymco	00130005
-------	----------

APPLICABILITÀ

Kymco Agility R16 50 4T 08-09, Agility R16 50 4T 12-12, Agility RS 50 4T 09-09, Like 50 4T 09-09, Super 8 50 4T 07-07, Super 8 4T 50 4T 09-09



◀ cod. **CA00008**
Centralina accensione per Piaggio Zip 50 4t '00-'05

RIFERIMENTO ORIGINALE

Piaggio	639978
---------	--------

APPLICABILITÀ

Aprilia Scarabeo 4T 50 4T 02-06, Scarabeo 4T Restyling EU3 50 4T 06-09
Derbi Atlantis 4T 50 4T 04-06

Piaggio Fly 4T 50 4T 05-07, Fly 4T & 25-30 KM/H 50 4T 08-11, Fly 4T 2V 50 4T 13-13, Fly 4T Motore CHN 50 4T 06-07, Liberty 4T 50 4T 00-02, Liberty 4T 50 4T 05-08, Liberty 4T Delivery - Single 50 4T 10-12, Liberty 4T Delivery TNT 50 4T 09-09, Liberty 4T PTT (DEU) 50 4T 07-12, Liberty 4T PTT - DOUBLE 50 4T 09-12, Liberty 4T RST 50 4T 04-04, Liberty 4T Sport 50 4T 06-08, Liberty MOC 4T & Elle 50 4T 09-13, Vespa ET4 50 4T 00-05, Vespa LX 4T 50 4T 05-08, Zip 4T 50 4T 00-05

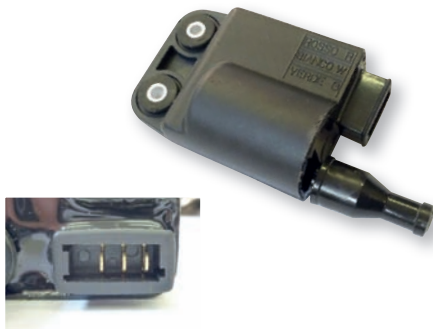

◀ cod. **CA00009**
Centralina Accensione Piaggio Liberty 50cc 2T

RIFERIMENTO ORIGINALE

Piaggio	58095R
---------	--------

APPLICABILITÀ

Aprilia Mojito 50 2T -, SR Carburatore 50 2T 14-14, SR Motard 50 2T 12-13, SR R 50 2T 04-09, SR R FACTORY Carburatore 50 2T -, SR Street Carburatore 50 2T 03-12, Scarabeo 2T EU2 Motore Piaggio 50 2T 10-12, Scarabeo 2T Net 50 2T 09-10, Scarabeo Street 50 2T 05-06, Scarabeo Street 2T Restyling 50 2T 06-09, Sport City One 2T 50 2T 08-11
Derbi Boulevard 50 2T 09-12, Variant Sport 2T 50 2T 12-12
Gilera DNA 50 2T 00-02, DNA 50 2T 05-07, DNA GP Experience 50 2T 03-04, Ice 50 2T 01-05, Runner Poggiali 50 2T 02-02, Runner SP 50 2T 02-07, Runner SP 50 2T 10-12, Runner SP ST & Simoncelli 50 2T 08-09, Runner SP Special Edition 50 2T 07-07, Stalker 50 2T 05-11, Stalker Naked 50 2T 08-08, Stalker Special Edition 50 2T 07-08, Storm Euro 2.50 2T 07-07

Piaggio Diesis 50 2T 01-01, Fly 2T 50 2T 05-07, Fly 2T 50 2T 10-11, Liberty 2T 50 2T 06-08, Liberty 2T Sport 50 2T 06-06, Liberty MOC 2T & Elle 50 2T -, NRG Power DD 50 2T 05-13, NRG Power DD Serie Speciale 50 2T -, NRG Power DT 50 2T 06-11, NRG Power DT Serie Speciale 50 2T 07-08, Typhoon 50 2T 01-11, Typhoon 2T E2 50 2T 10-12, Typhoon 2T E3 CH 50 2T 11-11, Vespa LX 2T 50 2T 05-08, Vespa LXV 2T 50 2T -, Vespa LXV 2T NAVY 50 2T 08-08, Vespa S 2T & College 50 2T 07-12, Zip 2T 50 2T -, Zip LC 50 2T 00-04, Zip Sp 50 2T 01-04, Zip Sp Euro 2.50 2T -



◀ cod. **CD00001**
Centralina scooter 50 cc Minarelli/Yamaha con volano giapponese 8 poli

RIFERIMENTO ORIGINALE

Ducati	434145000
--------	-----------



◀ cod. **CD00002**
Centralina per Minarelli AM6 con volano Ducati

RIFERIMENTO ORIGINALE

Ducati	432399010
--------	-----------

REGOLATORI



◀ cod. **RD00001**
Regolatore per Enduro 50 cc Malaguti/Yamaha

RIFERIMENTO ORIGINALE

Malaguti	02602100
----------	----------

Yamaha	1D4H35980000
--------	--------------

APPLICABILITÀ

Malaguti CNK Drakon 50 2T 05-07, XSM 50 50 2T -00, XTM 50 50 2T -00

Yamaha DTR 50 2T 03-06, DTRSM 50 2T 03-05, DTX 50 2T 06-06



◀ cod. **RE00004**
Regolatore per scooter 500cc Piaggio

RIFERIMENTO ORIGINALE

Piaggio	639110
Aprilia	639110

Gilera	639110
Derbi	639110

APPLICABILITÀ

Aprilia SR MAX 125 125 4T 11-14, Atlantic 250 EU3 250 4T 06-08, Scarabeo Light 250 250 4T 06-08, Sportcity 250 EU3 250 4T 06-08, Sportcity Cube 250 250 4T 08-12, SR MAX 300 300 4T 11-14, Scarabeo Light 300 300 4T 09-10, Sport City Street 300 300 4T 4V 12-12, Atlantic Sprint 400 400 4T 05-08, Scarabeo Light 400 400 4T 06-08, Atlantic 500 500 4T 01-04, Atlantic Sprint 500 500 4T 05-08, Scarabeo 500 500 4T 03-06, Scarabeo Light 500 500 4T 06-08

Derbi GP1 250 Low Seat EU3 250 4T 07-08, Rambla 250 250 4T 08-09, Rambla 250 EU3 2VER 250 4T 08-08, Rambla 300 300 4T 10-11

Gilera Nexus 125 IE EU3 125 4T 08-10, Nexus 250 EU3 250 4T 06-07, Nexus SP 250 EU3 250 4T 06-07, Nexus 300 EU3 300 4T 08-11, Fuoco 500 IE EU3 500 4T 07-13, Nexus 500 500 4T 03-05, Nexus 500 EU3 500 4T 06-11, Nexus SP 500 EU3 500 4T 06-07

Piaggio MP3 125 IE 125 4T 08-09, MP3 125 Ibrido 125 4T 09-10, Beverly 250 CRUISER 250 4T 07-09, Beverly 250 SPORT 250 4T 06-08, Beverly 250 Tourer EU3 250 4T 07-09, Beverly 250 ie EU3 250 4T 06-08, Carnaby 250 250 4T 08-08, MP3 250 250 4T 06-08, MP3 250 LT 250 4T 08-09, MP3 250 MIC 250 4T 08-09, Vespa GT 60 250 EU3 250 4T 06-07, Vespa GTS 250 250 4T 05-16, Vespa GTS ABS 250 250 4T 05-12, Vespa GTV 250 250 4T 06-09, Vespa GTV 4T NAVY EU3 250 250 4T 07-07, X-Evo 250 250 4T 07-16, X7 250 EU3 250 4T 08-08, X8 250 EU3 250 4T 05-08, Beverly Tourer 300 EU3 300 4T 09-10, Carnaby Cruiser 300 300 4T 09-12, Vespa GTS Super 300 4T 08-15, Beverly 400 EU3 400 4T 06-07, Beverly Tourer 400 EU3 400 4T 08-10, MP3 400 400 4T 07-08, MP3 400 IE LT Touring 400 4T 11-11, MP3 400 IE LT/Sport 400 4T 08-10, MP3 400 MIC 400 4T 08-10, MP3 400 RL Touring 400 4T 11-11, X-Evo 400 400 4T 07-11, X8 400 EU3 400 4T 06-08, Beverly 500 500 4T 02-06, Beverly 500 ie EU3 500 4T 06-08, Beverly Cruiser 500 500 4T 07-11, MP3 500 LT Sport/Business 500 4T -, MP3 500 RL Sport 500 4T -, X9 500 500 4T 01-02, X9 Evolution 500 500 4T 03-07, X9 Evolution ABS 500 500 4T 06-07



◀ cod. **RE00008**
Regolatore di tensione per Vespa PX 50-125 cc

RIFERIMENTO ORIGINALE

Piaggio	2308245
---------	---------

APPLICABILITÀ

Piaggio Ape 50 TM P 50 2T 85-89, Vespa FL 50 2T 90-90, Vespa N 50 2T 89-90, Vespa PK XL 50 2T 85-88, Vespa PK XL RUSH 50 2T 88-89, Cosa 2 125 2T 91-97, Cosa CL, CLX 125 2T 88-91, Vespa FL 125 125 2T 89-90, Vespa PK XL 125 125 2T 86-89, Vespa PX 125 125 2T 98-01, Vespa PX 125 125 2T 11-16, Vespa PX 125 EU2 125 2T 01-07, Vespa PX 30 Anni 125 2T 07-08, Cosa 2 150 2T 91-97, Cosa CL, CLX 150 2T 88-91, Vespa PX 150 150 2T 98-01, Vespa PX 150 150 2T 11-16, Cosa 2 200 2T 91-97, Cosa CL, CLX 200 2T 88-91, Vespa PX 200 200 2T 98-01



◀ cod. **RE00009**
Regolatore di tensione per Vespa PK 50-125cc

RIFERIMENTO ORIGINALE

Piaggio	2940165
---------	---------

APPLICABILITÀ

Gilera Easy Moving 50 2T 95-96, Storm 50 2T 94-95, Typhoon 50 2T 94-97

Piaggio Ape FL - FL2 50 2T 89-95, Ape FL3 50 2T 96-99, Free 50 2T 92-94, Free FL 50 2T 95-02, NRG 50 2T 94-96, NRG RST MC2 50 2T 96-98, NTT 50 2T 95-96, Quartz 50 2T 92-96, Sfera 50 2T 91-93, Sfera Maquillage 2 50 2T 94-94, Sfera RST 50 2T 95-97, Vespa ET2 50 2T 97-05, Vespa FL2 AUTOMATICA 50 2T 90-91, Vespa FL2 HP 50 2T 91-97, Zip 50 2T 92-93, Zip 50 2T 95-96, Zip Fast Rider 50 2T 93-94, Zip Fast Rider RST 50 2T 96-97, Zip RST 50 2T 96-99, Zip Sp 50 2T 96-00, Sfera 125 4T 95-97

REGOLATORI



◀ cod. **RE00010**
Regolatore di tensione per Vespa ET4 125 - PX Arcobaleno 125/150/200 cc

RIFERIMENTO ORIGINALE

Piaggio	1616395
---------	---------

APPLICABILITÀ

Piaggio Vespa PK XL PLURIMATIC 50 2T 85-90, Vespa PX E 125 Arcobaleno 125 2T 81-97, Vespa PXT5 125 125 2T 85-89, Vespa PX E 150 Arcobaleno 150 2T 81-97, Vespa PX E 200 Arcobaleno 200 2T 81-97



◀ cod. **RE00011**
Regolatore di tensione per Majesty 125cc

RIFERIMENTO ORIGINALE

Piaggio	58090R
Yamaha	5NRW1960000

APPLICABILITÀ



◀ cod. **RE00012**
Regolatore di tensione per Aprilia Scarabeo 50 2T - Ape '03/'10

RIFERIMENTO ORIGINALE

Piaggio	58096R
---------	--------

APPLICABILITÀ

Aprilia SR R 50 2T 04-09, SR R FACTORY Carburatore 50 2T -, SR Stealth 50 2T 97-99, SR Street Carburatore 50 2T 03-12, Scarabeo 2T EU2 Motore Piaggio 50 2T 10-12, Scarabeo 2T Net 50 2T 09-10, Scarabeo Street 50 2T 05-06, Scarabeo Street 2T Restyling 50 2T 06-09, Sport City One 2T 50 2T 08-11, Mojito Retró Custom 125 4T 99-01, SR Motard 125 125 4T-2V 12-12

Derbi Atlantis 02 50 2T 02-02, Boulevard 50 2T 09-12, GP1 50 2T 01-03, GP1 EU2 50 2T 05-05, GP1 Open EU2 50 2T 06-09, GP1 Race EU2 50 2T 05-07, Sonar 2T 50 2T 09-09

Gilera DNA 50 2T 00-02, DNA 50 2T 05-07, DNA GP Experience 50 2T 03-04, Ice 50 2T 01-05, Runner 50 2T 97-00, Runner Poggiali 50 2T 02-02, Runner SP 50 2T 02-07, Runner SP 50 2T 10-12, Runner SP ST & Simoncelli 50 2T 08-09, Runner SP Special Edition 50 2T 07-07, Stalker 50 2T 97-11, Stalker Naked 50 2T 08-08, Stalker Special Edition 50 2T 07-08, Storm Euro 2 50 2T 07-07, Typhoon X 50 2T 98-99, Typhoon XR 50 2T 00-00

Piaggio Ape EU2 50 2T 03-10, Ape RST MIX 50 2T 99-03, Diesis 50 2T 01-01, Fly 2T 50 2T 05-07, Fly 2T 50 2T 10-11, Free Delivery 50 2T 00-01, Liberty 50 2T 97-05, Liberty 2T 50 2T 06-08, Liberty 2T PTT EU2 50 2T 04-05, Liberty 2T RST 50 2T 04-04, Liberty 2T Sport 50 2T 06-08, Liberty MOC 2T & Elle 50 2T -, NRG Extreme 50 2T 99-00, NRG MC3 50 2T 01-04, NRG Power DD 50 2T 05-13, NRG Power DD Serie Speciale 50 2T -, NRG Power DT 50 2T 06-11, NRG Power DT Serie Speciale 50 2T 07-08, Typhoon 50 2T 01-11, Typhoon 2T E2 50 2T 10-12, Typhoon 2T E3 CH 50 2T 11-11, Vespa LX 2T 50 2T 05-08, Vespa LX 2T FL 50 2T 09-10, Vespa LXV 2T 50 2T -, Vespa LXV 2T NAVY 50 2T 08-08, Vespa S 2T & College 50 2T 07-12, Zip 2T 50 2T -, Zip LC 50 2T 00-04, Zip Sp 50 2T 01-04, Zip Sp Euro 2 50 2T -, Hexagon LX4 125 125 4T 98-99, Liberty 125 125 4T 98-00, Vespa ET4 125 125 4T 96-98



◀ cod. **RE00013**
Regolatore di tensione per Kymco - Sym

RIFERIMENTO ORIGINALE

Kymco	00169004
Malaguti	02601500

Sym	31600KBN920
-----	-------------

APPLICABILITÀ

Kymco Agility 4T R10 50 4T 06-08, Agility 4T R12 50 4T 07-08, Agility R12 50 4T 05-05, Bet & Win 50 2T 02-02, Bet & Win EU2 50 2T 03-03, CX 50 2T 93-93, CX Super 50 2T 94-97, DJ World 50 2T 94-00, DJ X 50 2T 91-92, DJ Y 50 2T 93-93, Dink LC 50 2T 98-02, Dink Classic EU2 50 2T 03-03, Dink Euro 2 50 4T 07-07, Fever ZX 50 2T 99-00, Fever ZX EU2 50 2T 03-04, Filly 50 4T 98-00, Filly LX 50 4T 01-02, Heroism 50 2T 95-97, K 12 50 2T 95-00, KB 50 2T 95-00, Mxer 50 2T 02-03, Mxer EU2 50 2T 04-04, People 50 2T 99-04, People Euro 2 50 2T 03-03, People Euro 2 50 2T 08-08, People S 4T 50 4T 06-08, Sniper 50 2T 93-93, Sniper DD 50 2T 94-96, Super 9 50 2T 00-00, Super 9 EU2 50 2T 03-04, Top Boy 50 2T 97-00, Vitality 2T 50 2T 04-04, Vitality 4T 50 4T 04-04, Yup 50 2T 02-02, Yup EU2 50 2T 03-03, Agility 125 125 4T 06-06, Agility 125 EU3 125 4T 06-08, Movie 125 125 4T 99-00, Movie 125 EU3 125 4T 06-07,

Kymco Movie XL 125 125 4T 01-01, Movie XL 125 EU2 125 4T 03-04, People 125 125 4T 99-00, People 125 EU2 125 4T 03-03, People 125 EU3 125 4T 07-08, Vivio 125 125 4T 00-00, Movie 150 EU3 150 4T 06-07, Movie XL 150 150 4T 01-01, Movie XL 150 EU2 150 4T 03-04, People 150 150 4T 99-00, People 150 EU2 150 4T 03-03, Vivio 150 150 4T 00-00

Malaguti Ciak 125 125 4T 00-01, Ciak Master 125 125 4T 04-04, Ciak Restyling EU2 125 125 4T 03-03, Ciak 150 150 4T 00-02, Ciak Master 150 150 4T 04-04, Ciak Restyling EU2 150 150 4T 03-03

Sym Jet 50 2T 99-01, Jungle 50 2T 99-00, Mask 50 2T 00-01, Red Devil 50 2T 99-99, Super Fancy 50 2T 98-00, Jet 100 100 2T 99-00, Super Duke 125 125 4T 99-02, Super Duke 150 150 4T 99-02

REGOLATORI



◀ cod. **RE00014**
Regolatore di tensione per F10-F12 - Booster - Nitro

RIFERIMENTO ORIGINALE

Aprilia	AP8212799
Malaguti	02601100

Yamaha	4VH19600100
--------	-------------

APPLICABILITÀ

Aprilia Amico 50 2T 94-94, Amico 50 2T 96-98, Amico GL/GLE 50 2T 93-95, Amico LX/Sport/Cat 50 2T 92-93, Gulliver 50 2T 95-98, Gulliver LC 50 2T 96-98, Rally 50 2T 95-03, Rally Liquid Cooled 50 2T 96-99, SR (Orizzontale) 50 2T 94-96, SR (Verticale) 50 2T 93-93, SR Liquid Cooled 50 2T 94-96, SR Recing 50 2T 97-99, SR Stealth 50 2T 97-99, SR WWW 50 2T 97-01, Scarabeo 50 2T 93-05, Scarabeo 2T Net 50 2T 10-10, Sonic 50 2T 98-07, Sonic GP 50 2T 98-08, Scarabeo 100 (Minarelli) 100 2T 00-00, Scarabeo 100 (Yamaha) 100 2T 00-00

Mbk Booster 50 2T -00, Booster NG 50 2T -00, Booster Rocket 50 2T 97-98, Booster Spirit 50 2T -00, Booster Track 50 2T 96-98, Evolis 50 2T 92-95, Fizz 50 2T 94-95, Flipper 50 2T -00, Forte 50 2T 94-96, Nitro 50 2T -00, Ovetto 50 2T -00, Stunt 50 2T 00-02, Nitro 100 100 2T 00-02

Yamaha Aerox 50 2T -00, Axis 50 2T 95-96, BWS 50 2T -00, BWS Bump 50 2T 97-98, BWS NG 50 2T -00, Breeze 50 2T 94-95, Neo's 50 2T -00, Slider 50 2T 00-02, Spy 50 2T 95-98, Why 50 2T -00, Aerox 100 100 2T 00-02

Malaguti Centro 50 2T -00, Ciak 50 2T -00, Ciak Euro 2 50 2T 01-03, Crosser CR1 50 2T 95-98, F10 50 2T -00, F10 Euro 2 50 2T -00, F10 Wap Euro 2 50 2T -00, F12 Phantom Euro 2 50 2T 02-02, F12 Phantom LC 50 2T -00, F12 R Phantom 50 2T 07-07, F12 Restyling Euro 1 50 2T 99-02, F15 Firefox 50 2T -00, F15 Firefox Euro 2 50 2T 02-06, Yesterday 50 2T 97-00, Ciak 100 100 4T 99-00, F12 Phantom 100 100 4T 99-00



◀ cod. **RE00015**
Regolatore di tensione per Yamaha - BWS - Aerox - Neo's - Nitro

RIFERIMENTO ORIGINALE

Yamaha	5RNH19600000
--------	--------------

APPLICABILITÀ

Mbk Booster Euro 2 50 2T 04-04, Booster NG 50 2T 03-03, Booster Spirit 50 2T 03-03, Flipper Euro 2 50 2T 03-03, Mach G 50 2T 02-04, Mach G LC 50 2T 02-04, Nitro Euro 2 50 2T 03-03, Ovetto Euro 2 50 2T 02-02, Ovetto 100 100 2T 99-02

Yamaha Aerox Euro 2 50 2T 03-03, BWS Euro 2 50 2T 03-03, BWS NG Euro 2 50 2T 03-03, DT R 50 2T 07-10, DT X 50 2T 07-10, Jog R 50 2T 02-10, Jog R LC 50 2T -00, Neo's Euro 2 50 2T 02-02, TZR 50 2T 03-08, TZR 50 2T 10-11, TZR RR 50 2T 05-05, Why Euro 2 50 2T 03-03, Neo's 100 100 2T 99-02, XT-R 125 4T-2V 05-08, XT-X 125 4T-2V 05-08



◀ cod. **RE00018**
Regolatore di tensione per Scarabeo 50-100cc 4T - Vespa LX 4T

RIFERIMENTO ORIGINALE

Piaggio	9693825
---------	---------

Malaguti	02602800
----------	----------

APPLICABILITÀ

Aprilia Scarabeo 4T 50 4T 02-06, Scarabeo 4T Restyling EU3 50 4T 06-09, Scarabeo 4T 100 100 4T 01-04, Scarabeo 4T 100 100 4T 10-12, Scarabeo 4T NET 100 100 4T 10-10, Scarabeo 4T NET EU3 100 100 4T 10-10, Scarabeo 4T Restyling 100 100 4T 06-09

Derbi Atlantis 4T 50 4T 04-06, Boulevard 4T EU2 25KM/H 50 4T-, Boulevard 4T 100 100 4T 10-10

Malaguti Centro Euro 2 50 4T 08-08, Centro SL 4T 50 4T 10-10, Ciak Master Euro 2 50 4T 05-06

Piaggio Fly 4T 50 4T 05-07, Fly 4T Motore CHN 50 4T 06-07, Liberty 4T 50 4T 00-02, Liberty 4T 50 4T 05-08, Liberty 4T Delivery - Single 50 4T 10-12, Liberty 4T Delivery TNT 50 4T 09-09, Liberty 4T PTT - DOUBLE 50 4T 09-12, Liberty 4T RST 50 4T 04-04, Liberty 4T Sport 50 4T 06-08, Liberty MOC 4T & Elle 50 4T 09-13, Vespa ET4 50 4T 00-05, Vespa LX 4T 50 4T 05-08, Zip 4T 50 4T 00-13, Fly 100 100 4T 06-08, Free 100 100 4T 02-03, Zip 100 100 4T 06-10



◀ cod. **RE00019**
Regolatore di tensione per People S 250 cc '08/'10 - Agility 125/150 cc R16 '09/'10

RIFERIMENTO ORIGINALE

Kymco	00169587
-------	----------

Malaguti	02603000
----------	----------

APPLICABILITÀ

Kymco Agility R16 50 4T 08-09, Agility R16 50 4T 12-12, Agility R16 2T 50 2T 10-10, Agility R16 2T 50 2T 12-12, Agility RS 50 4T 09-09, Agility RS Naked 50 2T 10-10, Like 50 2T 09-09, Like 50 4T 09-09, Super 8 50 2T 09-09, Super 8 4T 50 4T 07-07, Super 8 4T 50 4T 09-09, Agility 125 R16 125 4T 08-09, Agility 125 RS 125 4T 09-09, Agility Plus 125 4T 14-14, Agility R16 125 4T 12-12, Like 125 125 4T 09-09, People S 125 125 4T 05-05, People S DD EU3 125 125 4T 07-08, Super 8 125 125 4T 08-09, Agility 150 R16 150 4T 08-09, Like LX 200 4T 12-12, People S 200 200 4T 05-05

Malaguti Ciak Master EU3 125 125 4T 06-06, Ciak Master 200 EU2 200 4T 06-06

REGOLATORI



cod. RE00020

Regolatore di tensione per Majesty 125/150 cc '98/'00-Skyliner 125/150-Madison 125/150 cc

RIFERIMENTO ORIGINALE

Yamaha	5NRW19600000
--------	--------------

APPLICABILITÀ

Mbk Skyliner 125 125 4T 98-02, Doodo 150 150 4T 01-02, Skyliner 150 150 4T 00-02
Yamaha Majesty 125 125 4T 98-02, Majesty 150 150 4T 00-02, Teo's 150 150 4T 01-02



cod. RE00021

Regolatore di tensione per Honda SH 125/150cc ie '05/'10

RIFERIMENTO ORIGINALE

Honda	31600-KTF-641
-------	---------------

APPLICABILITÀ

Honda SH IE 125 Scoopy 125 4T-2V 05-12, SH IE 150 Scoopy 150 4T 05-12



cod. RE00022

Regolatore di Tensione Yamaha T-MAX 500 '08-'09

RIFERIMENTO ORIGINALE

Yamaha	4XY819600000
--------	--------------

APPLICABILITÀ

Yamaha Drag Star XVS 125 4T 00-03, Drag Star XVS 250 4T 04-04, Majesty 250 250 4T 02-03, Majesty 250 ABS 250 4T 03-03, WR250R 250 4T 08-08, WR250R 250 4T 13-13, WR250X 250 4T 08-08, X-Max 250 250 4T 05-06, YBR 250 4T 07-11, Versity 300 300 4T 03-06, Majesty 400 400 4T 04-11, Majesty 400 ABS 400 4T 07-11, SR400 400 4T 14-14, T-Max 4B5 500 500 4T 09-11, T-Max 4B5 ABS 500 4T 08-11, T-Max 5VU 500 500 4T 08-08, T-Max SV 500 4T 11-11, T-Max SV ABS 500 4T 11-11, T-Max White Max 500 4T 10-10, YZF R6 600 4T 07-14, YZF R6 & Limited Edition 07 600 4T 06-06, YZF R6 50TH 600 4T 12-12, MT-03 660 4T 06-11, XY660Z TENERE 660 4T 08-13, Drag Star Classic XVS A 1100 4T 03-03, Drag Star Classic XVS A 1100 4T 05-06, Royal Star Venture TF XVZ 1300 4T 00-00



cod. RE00023

Regolatore di Tensione Yamaha X-MAX 250cc '07-'09

RIFERIMENTO ORIGINALE

Yamaha	5BN819600000
--------	--------------

APPLICABILITÀ

Sym Symple II 125 125 4T 09-10

Yamaha Drag Star XVS 125 4T 04-04, X-City 125 EU3 125 4T-4V 08-11, X-Max R 125 125 4T-4V 06-09, X-Max R 125 125 4T-4V 12-16, X-Max RA 125 ABS 125 4T-4V 13-16, Drag Star XVS 250 4T 01-03, X-City 250 250 4T 07-13, X-Max 250 250 4T 07-09, X-Max 250 250 4T 14-14, X-Max 250 ABS 250 4T 14-14, X-Max 250 Black 250 4T 09-09, Drag Star Classic XVS A 650 4T 98-01, Drag Star XVS 650 4T 97-02, Bulldog BT 1100 4T 02-06, Drag Star Classic XVS A 1100 4T 00-02, Drag Star XVS 1100 4T 99-02, Wild Star XV A 1600 4T 99-02



cod. RE00024

Regolatore di Tensione Derbi Senda X-Treme 50cc

APPLICABILITÀ

Aprilia RS 50 50 2T 06-10, RS4 50 2T 11-13, RX 50 50 2T 06-10, RX 50 50 2T 14-, SX 50 2T 06-10, SX 50 2T 14-14, SX 50 50 2T -, SX Limited Edition 50 2T 14-14

Derbi GPR 2T 50 2T 13-13, GPR 2T EU2 50 2T 09-10, GPR NUDE 50 2T 04-05, GPR NUDE & GPR NUDE Tuning 50 2T 06-08, GPR NUDE Sport 50 2T 06-06, GPR R EU2 - GPR Replica EU2 50 2T 08-08, GPR Racing 50 2T 04-05, GPR Racing EU2 50 2T 06-06, GPR Replica 50 2T 99-01, GPR Replica & GPR R EU2 50 2T 06-06, GPR Replica 2T Malossi 50 2T 07-07, GPR Replica Pesek EU2 50 2T 07-07, GPR Replica Racing 50 2T 02-03, GPR Replica Racing EU2 50 2T 05-05, Sebda R Racer 50 2T 03-03, Senda Black Edition 50 2T 03-03, Senda HYP DRD Evo EU2 50 2T 08-09, Senda HYP DRD Evo Limited Edition EU2 50 2T 08-08, Senda R 50 2T 00-01, Senda R DRD EU1 EU1R 50 2T 02-02, Senda R DRD PRO EU2 50 2T 05-11, Senda R DRD Racing EU2 50 2T 05-08, Senda R X-RACE 50 2T 05-05, Senda R X-RACE 2T EU2 50 2T 10-10, Senda R X-RACE EU2 50 2T 06-09, Senda R X-TREME 50 2T 03-03, Senda R X-TREME 50 2T 05-05, Senda R X-TREME 2T EU2 50 2T -, Senda R X-TREME EU2 50 2T 05-08, Senda SM 50 2T 00-01, Senda SM DRD EU1 EU1R 50 2T 02-03, Senda SM DRD PRO EU2 50 2T 05-11, Senda SM DRD Racing EU2 50 2T 05-08, Senda SM DRD Racing LTD EU2 50 2T 07-07, Senda SM X-RACE 50 2T 05-05, Senda SM X-RACE 2T EU2 50 2T 10-10, Senda SM X-RACE EU2 50 2T 06-09, Senda SM X-TREME 50 2T 02-03, Senda SM X-TREME 2T EU2 50 2T 10-10, Senda SM X-TREME EU2 50 2T 07-08

Gilera RCR 50 2T 03-03, RCR 50 2T 06-07, RCR 50 2T 11-13, SMT 50 2T 03-03, SMT 50 2T 13-, SMT Racing 50 2T 11-12

REGOLATORI



◀ cod. **RE00025**
Regolatore di Tensione Derbi Atlantis 50cc

APPLICABILITÀ

Derbi Atlantis 50 2T 99-01, Atlantis LC 50 2T 99-01, Bultaco Lobito 50 2T 98-01, Predator LC 50 2T 98-01, Predator 02 50 2T 98-01, Atlantis 100 100 2T 00-01

Piaggio Diesis 100 100 2T 01-01

RIFERIMENTO ORIGINALE

Derbi	00G01001841
-------	-------------

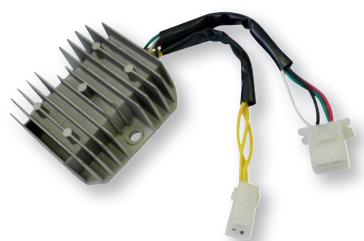

◀ cod. **RE00026**
Regolatore di Tensione Kymco Dink 125/150cc

APPLICABILITÀ

Kymco B&W 125 125 4T 00-00, B&W 125 EU2 125 4T 03-04, Dink 125 125 4T 97-98, Dink Classic 125 125 4T 02-02, Dink Classic 125 EU2 125 4T 03-03, Dink LX 125 125 4T 98-00, Grand Dink 125 125 4T 01-02, Grand Dink 125 EU2 125 4T 03-04, Heroism 125 125 4T 95-97, B&W 150 150 4T 00-00, B&W 150 EU2 150 4T 03-04, Dink 150 150 4T 97-98, Dink Classic 150 150 4T 02-02, Dink Classic 150 EU2 150 4T 03-03, Dink LX 150 150 4T 98-00, Grand Dink 150 150 4T 01-02, Grand Dink 150 EU2 150 4T 03-04, Heroism 150 150 4T 95-97, Dink Classic 200 200 4T 04-04, People S 200 1200 4T 07-07, B&W 250 250 4T 00-00, B&W 250 EU2 250 4T 03-03, Grand Dink 250 250 4T 01-02, Grand Dink 250 EU2 250 4T 03-04, People LC 250 250 4T 03-04, Xciting 250 250 4T 05-05, Yup 250 250 4T 03-03

RIFERIMENTO ORIGINALE

Kymco	00168780
-------	----------



◀ cod. **RE00028**
Regolatore di Tensione Kymco Downtown 300cc



◀ cod. **RE00029**
Regolatore di Tensione Honda SH 300cc dal 2011



◀ cod. **RE00030**
Regolatore di Tensione Yamaha X-MAX 250cc

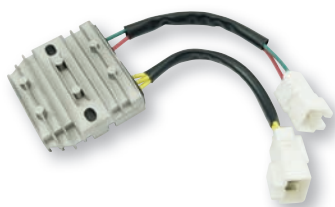

◀ cod. **RE00031**
Regolatore di Tensione Honda SH 300cc '07-'10

STATORI



◀ cod. **SD00002**
Statore per 50 cc Minarelli/Yamaha volano Ducati



◀ cod. **SD00010**
Statore per Minarelli AM6 volano Ducati (cavo lungo)

◀ cod. **SD00011**
Statore per Minarelli AM6 volano Ducati (cavo corto)



◀ cod. **ST00002**
Statore completo per motore Minarelli/Yamaha 125cc

RIFERIMENTO ORIGINALE

Yamaha	5DSH55100000
--------	--------------

Mbk	5DSH55100000
-----	--------------

APPLICABILITÀ

Mbk Dodo 125 125 4T 00-00, Skyliner 125 125 4T 98-02, Skyliner E 125 125 4T 03-03, Thunder 125 125 4T 01-02, Dodo 150 150 4T 01-02, Skyliner 150 150 4T 00-02, Thunder 150 150 4T 01-02, Skyliner E 180 180 4T 03-03

Yamaha Majesty 125 125 4T 98-02, Majesty 125 E 125 4T 03-09, Maxter 125 125 4T 01-02, Teo's 125 125 4T 00-00, Majesty 150 150 4T 00-02, Maxter 150 150 4T 01-02, Teo's 150 150 4T 01-02, Majesty 180 E 180 4T 03-06



◀ cod. **ST00004**
Statore per scooter 50 cc 4T Piaggio/Gilera

RIFERIMENTO ORIGINALE

Piaggio	969228
Aprilia	969228

Derbi	969228
-------	--------

APPLICABILITÀ

Aprilia Scarabeo 4T 50 4T 02-06, Scarabeo 4T Restyling EU3 50 4T 06-09, Sport City One 4T 50 4T 08-10, Scarabeo 4T 100 4T 01-04, Scarabeo 4T 100 100 4T 10-12, Scarabeo 4T NET 100 100 4T 10-10, Scarabeo 4T NET EU3 100 100 4T 10-10, Scarabeo 4T Restyling 100 100 4T 06-09

Derbi Atlantis 4T 50 4T 04-06, Atlantis 4T EU2 50 4T 07-07, Boulevard 4T EU2 25KM/H 50 4T -, Boulevard 4T 100 100 4T 10-10

Piaggio Fly 4T 50 4T 05-07, Fly 4T & 25-30 KM/H 50 4T 08-11, Fly 4T Motore CHN 50 4T 06-07, Liberty 4T 50 4T 00-02, Liberty 4T 50 4T 05-08, Liberty 4T Delivery - Single 50 4T 10-12, Liberty 4T Delivery TNT 50 4T 09-09, Liberty 4T PTT - DOUBLE 50 4T 09-12, Liberty 4T RST 50 4T 04-04, Liberty 4T Sport 50 4T 06-08, Liberty MOC 4T & Elle 50 4T 09-13, Vespa ET4 50 4T 00-05, Vespa LX 4T 50 4T 05-08, Zip 4T 50 4T 00-13, Fly 100 100 4T 06-08, Free 100 100 4T 02-03, Zip 100 100 4T 06-10



◀ cod. **ST00005**
Statore per scooter 500cc Piaggio

RIFERIMENTO ORIGINALE

Piaggio	58080R
---------	--------

Gilera	58080R
--------	--------

APPLICABILITÀ

Aprilia Atlantic Sprint 400 400 4T 05-08, Scarabeo Light 400 400 4T 06-08, Atlantic 500 500 4T 01-04, Atlantic Sprint 500 500 4T 05-08, Scarabeo 500 500 4T 03-06, Scarabeo Light 500 500 4T 06-08

Gilera Nexus 500 500 4T 03-05, Nexus 500 EU3 500 4T 06-11, Nexus SP 500 EU3 500 4T 06-07

Piaggio Beverly 400 EU3 400 4T 06-07, X-Evo 400 400 4T 07-11, X8 400 EU3 400 4T 06-08, Beverly 500 500 4T 02-06, Beverly 500 ie EU3 500 4T 06-08, X9 Evolution 500 500 4T 03-07, X9 Evolution ABS 500 500 4T 06-07

STATORI

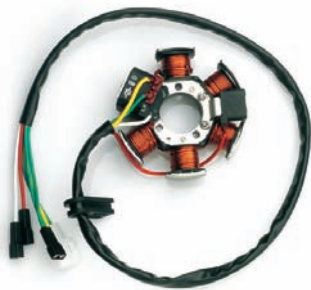

◀ cod. **ST00007**
Statore per Derbi Senda 85w (nuovo modello)

RIFERIMENTO ORIGINALE

Derbi	00H03300701
-------	-------------

APPLICABILITÀ

Aprilia RX 50 50 2T 06-, SX 50 2T 06-10, SX 50 50 2T -
Derbi Bultaco Lobito 50 2T 98-01, Sebda R Racer 50 2T 03-03, Senda Black Edition 50 2T 03-03, Senda HYP DRD Evo EU2 50 2T 08-09, Senda R 50 2T 99-99, Senda R DRD EU1 EU1R 50 2T 02-02, Senda R DRD Racing 50 2T 04-05, Senda R DRD Racing EU2 50 2T 05-08, Senda R DRD Racing LTD 50 2T 05-05, Senda R X-RACE 50 2T 04-05, Senda R X-RACE 2T EU2 50 2T 10-10, Senda R X-RACE EU2 50 2T 06-09, Senda R X-TREME 50 2T 05-05, Senda R X-TREME 2T EU2 50 2T -, Senda R X-TREME EU2 50 2T 05-08, Senda SM 50 2T 00-01,

Derbi Senda SM DRD EU1 EU1R 50 2T 02-03, Senda SM DRD Edition Black 50 2T 05-05, Senda SM DRD Racing 50 2T 04-05, Senda SM DRD Racing EU2 50 2T 05-08, Senda SM DRD Racing LTD 50 2T 05-05, Senda SM DRD Racing LTD EU2 50 2T 07-07, Senda SM X-RACE 50 2T 04-05, Senda SM X-RACE 2T EU2 50 2T 10-10, Senda SM X-RACE EU2 50 2T 06-09, Senda SM X-TREME 50 2T 02-03, Senda SM X-TREME 2T EU2 50 2T 10-10, Senda SM X-TREME EU2 50 2T 04-08
Gilera RCR 50 2T 06-07, RCR 50 2T 11-12, SMT 50 2T 03-03, SMT 50 2T 06-07, SMT 50 2T 11-11, SMT Racing 50 2T 11-12



◀ cod. **ST00008**
Statore per Derbi Senda GPR

RIFERIMENTO ORIGINALE

Derbi	00H03360011
-------	-------------

APPLICABILITÀ

Aprilia RS 50 50 2T 06-10, RS4 50 2T 11-13

Derbi GPR 2T EU2 50 2T 09-10, GPR NUDE & GPR NUDE Tuning 50 2T 06-08, GPR NUDE Sport 50 2T 06-06, GPR R EU2 - GPR Replica EU2 50 2T 08-08, GPR Racing EU2 50 2T 06-06, GPR Replica & GPR R EU2 50 2T 06-06, GPR Replica 2T Malossi 50 2T 07-07, GPR Replica Pesek EU2 50 2T 07-07, Senda HYP DRD Evo Limited Edition EU2 50 2T 08-08, Senda R DRD PRO EU2 50 2T 05-11, Senda SM DRD PRO EU2 50 2T 05-11

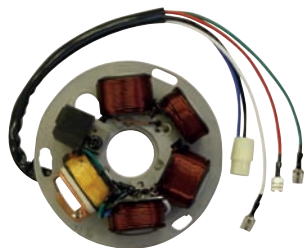

◀ cod. **ST00012**
Statore per Piaggio Vespa PX 125

RIFERIMENTO ORIGINALE

Piaggio	217866
---------	--------

APPLICABILITÀ

Piaggio Vespa PX 125 125 2T 98-01, Vespa PX 125 125 2T 11-16, Vespa PX 125 EU2 125 2T 01-07, Vespa PX 30 Anni 125 2T 07-08, Vespa PX E 125 Arcobaleno 125 2T 81-97, Vespa PX 150 150 2T 98-01, Vespa PX 150 150 2T 11-16, Vespa PX E 150 Arcobaleno 150 2T 81-97, Vespa PX 200 200 2T 98-01, Vespa PX E 200 Arcobaleno 200 2T 81-97



◀ cod. **ST00019**
Statore Per Yamaha T-Max 500Cc 2004-2007

RIFERIMENTO ORIGINALE

Yamaha	5VU814100000
--------	--------------

APPLICABILITÀ

Yamaha T-Max 5VU 500 500 4T 04-07, T-Max 5VU ABS 500 500 4T 05-07, T-Max 5VU BLACK MAX 500 4T 06-06, T-Max 5VU BLACK MAX - NIGHT MAX 500 4T 07-07



◀ cod. **ST00020**
Statore Per Yamaha T-Max 530Cc

RIFERIMENTO ORIGINALE

Yamaha	59C814100000
--------	--------------

APPLICABILITÀ

Yamaha T-Max 59C 530 530 4T 12-16, T-Max 59C 530 ABS 530 4T 12-16, T-Max 59C 530 SP 530 4T 15-15, T-Max 59C 530 SP ABS 530 4T 15-16

STATORI



◀ cod. **ST00021**
Statore Per Yamaha T-Max 500Cc 2008-2011

RIFERIMENTO ORIGINALE

Yamaha	4B5814100000
--------	--------------

APPLICABILITÀ

Yamaha T-Max 4B5 500 500 4T 09-11, T-Max 4B5 ABS 500 500 4T 08-11, T-Max 5VU 500 500 4T 08-08, T-Max SV 500 4T 11-11, T-Max SV ABS 500 4T 11-11, T-Max White Max 500 4T 10-10



◀ cod. **ST00023**
Statore Per Piaggio Beverly 250/300Cc

RIFERIMENTO ORIGINALE

Piaggio	58070R
---------	--------

APPLICABILITÀ

Aprilia Atlantic 125 EU3 125 4T 06-08, SR MAX 125 4T-4V 11-14, Sportcity 125 EU3 125 4T 06-08, Atlantic 250 EU3 250 4T 06-08, Scarabeo Light 250 250 4T 06-08, Sportcity Cube 250 250 4T 08-12, Scarabeo Light 300 300 4T 09-10

Derbi Rambla 125 125 4T 08-09, Rambla 125 EU3 2VER 125 4T 08-08, GP1 250 Low Seat EU3 250 4T 07-08, Rambla 250 250 4T 08-09, Rambla 300 300 4T 10-11

Gilera Nexus 125 IE EU3 125 4T 08-10, Nexus 250 EU3 250 4T 06-07, Nexus SP 250 EU3 250 4T 06-07, Nexus 300 EU3 300 4T 08-11

Piaggio MP3 125 IE 125 4T 08-09, MP3 125 Ibrido 125 4T 09-10, Beverly 250 CRUISER 250 4T 07-09, Beverly 250 EURO 3 MIC 250 4T 07-07, Beverly 250 SPORT 250 4T 06-08, Beverly 250 Tourer EU3 250 4T 07-09, Beverly 250 ie EU3 250 4T 06-08, Carnaby 250 250 4T 08-08, MP3 250 250 4T 06-08, MP3 250 LT 250 4T 08-09, MP3 250 MIC 250 4T 08-09, Vespa GT 60 250 EU3 250 4T 06-07, Vespa GTS 250 250 4T 05-16, Vespa GTS ABS 250 250 4T 05-12, Vespa GTV 250 250 4T 06-09, Vespa GTV 4T NAVY EU3 250 250 4T 07-07, X-Evo 250 250 4T 07-16, X7 250 EU3 250 4T 08-08, X8 250 EU3 250 4T 05-08, Beverly Tourer 300 EU3 300 4T 09-10, Carnaby Cruiser 300 300 4T 09-12, Vespa GTV VIA MONTE-NAPOLEONE 300 4T 10-10



◀ cod. **ST00024**
Statore Per Honda Sh 300Cc 2007-2010

RIFERIMENTO ORIGINALE

Honda	31120-KTW-901
-------	---------------

APPLICABILITÀ

Honda SH IE 300 Scoopy 300 4T-4V 07-10



◀ cod. **ST00026**
Statore Per Honda Sh 125Cc ie 2005-2012

RIFERIMENTO ORIGINALE

Honda	31120-KTF-640
-------	---------------

APPLICABILITÀ

Honda SH IE 125 Scoopy 125 4T-2V 05-12, SH IE 150 Scoopy 150 4T 05-12

INTERMITTENZE



◀ cod. **ME00001**
Intermittenza frecce Vespa PX125-150-200

RIFERIMENTO ORIGINALE

Piaggio	195703
---------	--------

VALVOLE LAMELLARI



◀ cod. **XX01021**
Valvola lamellare per motori scooter 50cc Minarelli/Yamaha tipo verticale.
Lamella acciaio spess. 0,15 mm

APPLICABILITÀ

Aprilia Amico 50 2T 94-94, Amico 50 2T 96-98, Amico GL/ GLE 50 2T 93-95, Amico LX/Sport/Cat 50 2T 92-93, SR (Verticale) 50 2T 93-93

Mbk Booster 50 2T -00, Booster Euro 2 50 2T 04-04, Booster NG 50 2T 03-00, Booster Rocket 50 2T 97-98, Booster Spirit 50 2T 03-00, Booster Track 50 2T 96-98, Stunt 50 2T 00-02

Yamaha BWS 50 2T -00, BWS Bump 50 2T 97-98, BWS Euro 2 50 2T 03-03, BWS NG 50 2T -00, BWS NG Euro 2 50 2T 03-03, Slider 50 2T 00-02, Spy 50 2T 95-98, Zuma 50 2T 97-10



◀ cod. **XX01022**
Valvola lamellare per motore scooter 50 cc Minarelli/Yamaha tipo orizzontale.
Lamella acciaio spess. 0,15 mm

APPLICABILITÀ

Aprilia Area 51 50 2T 98-00, Gulliver 50 2T 95-98, Gulliver LC 50 2T 96-98, Rally 50 2T 95-03, Rally Liquid Cooled 50 2T 96-99, SR (Orizzontale) 50 2T 94-96, SR Liquid Cooled 50 2T 94-96, SR Recing 50 2T 97-99, SR Stealth 50 2T 97-99, SR WWW 50 2T 97-01, Scarabeo 50 2T 93-05, Sonic 50 2T 98-07, Sonic GP 50 2T 98-08

Atala Carosello 50 2T -00

Benelli 491 GT 50 2T 98-99, 491 RR 50 2T 99-01, 491 Racing 50 2T 98-99, 491 SP 50 2T 99-99, 491 ST 50 2T 99-01, 491 Sport 50 2T 98-99, K2 50 2T 98-01, K2 Liquid Cooled 50 2T 98-01, Naked 50 2T 02-02, Pepe 50 2T 99-01, Pepe LX 50 2T 03-04

Beta Ark 50 2T 96-08, Ark LC 50 2T 96-08, Chrono 50 2T 96-00, Eikon 50 2T 99-03, Quadra 50 2T 95-00, Tempo 50 2T 95-00

Italjet Dragster 50 2T -00

KTM K50 50 2T -00

Macal Thunder 50 2T -00

Malaguti Centro 50 2T -00, Ciak 50 2T -00, Ciak Euro 2 2,3 50 2T 03-03, Ciak Euro2 50 2T 01-03, Ciak Master Euro 2 50 2T 06-06, F10 50 2T -00, F10 Euro 2 50 2T -00, F10 Euro 2 2,3 50 2T 03-04, F10 Restyling Euro 2 50 2T 06-06, F12 Phantom 50 2T -00, F12 Phantom Euro 2 50 2T 02-02, F12 Phantom Euro 2 2,3 50 2T 03-04, F12 Phantom LC 50 2T -00, F12 Phantom LC Euro 2 2,3 50 2T 03-04, F12 R Phantom LC 50 2T 07-09, F12 Restyling Euro 1 50 2T 99-02, F12 Restyling Euro 2 50 2T 06-06, F12 Restyling LC Euro 2 50 2T 06-06, F15 Firefox 50 2T -00, F15 Firefox Euro 2 50 2T 02-06, F15 Firefox Euro 2 2,3 50 2T 03-04, Yesterday 50 2T 97-00

Mbk Evolis 50 2T 92-95, Fizz 50 2T 94-95, Flipper 50 2T -00, Flipper Euro 2 50 2T 03-03, Forte 50 2T 94-96, Mach G 50 2T 02-04, Mach G LC 50 2T 02-04, Nitro 50 2T -00, Nitro Euro 2 50 2T 03-03, Ovetto 50 2T -00, Ovetto Euro 2 50 2T 02-02

Motron Syncro 50 2T -00, Thunder 50 2T -00

Rieju First 50 2T -00, Windy 50 2T -00

Yamaha Aerox 50 2T -00, Aerox Euro 2 50 2T 03-03, Axis 50 2T 95-96, Breeze 50 2T 94-95, Jog 50 2T -00, Jog R 50 2T 02-10, Jog R LC 50 2T -00, Neo's 50 2T -00, Neo's Euro 2 50 2T 02-02, Why 50 2T -00, Why Euro 2 50 2T 03-03, Zest 50 2T -00



◀ cod. **CB03002**
Carburatore SHA 13-13 (Si) 1851

◀ cod. **CB03003**
Carburatore SHA 13-13 (Ciao,PX) 2044

◀ cod. **CB03008**
Carburatore SHBC 19-19 (Vespa) 773

◀ cod. **CB03012**
Carburatore SHA 12-12 (Si) 1800

◀ cod. **CB03013**
Carburatore PHVA 17.5 ED (Sfera-Zip)1012

◀ cod. **CB03014**
Carburatore PHBN 17.5 LS (Booster-Amico) 3067

◀ cod. **CB03016**
Carburatore PHVA 17,5 LS Phantom 1097



◀ cod. **CB03017**
Carburatore PHVA 17,5 US REG. (Honda) 1438



◀ cod. **CB03020**
Carburatore PHBG 19 DS (R.2631) con resca depressore e arrivo olio



◀ cod. **CB03021**
Carburatore PHBG 19 DD scooter Piaggio (R.2685) con resca depressore e arrivo olio



◀ cod. **CB03022**
Carburatore PHBG 21 DS scooter (R.2632) con resca depressore e arrivo olio



◀ cod. **CB03023**
Carburatore PHBG 21 BS (R.2660) con resca depressore e arrivo olio



◀ cod. **CB03024**
Carburatore PHBG 21 BD scooter Piaggio (R.2665) con resca depressore e arrivo olio



◀ cod. **CB03025**
Carburatore PHBG 21 BS plurimarce (R.2671) con resca depressore e arrivo olio

ALBERI ENTRATA MOTO



- ◀ cod. **CI07488**
Ingranaggio doppio intermedio Z=12/48 motore scooter 50 cc Minarelli/Yamaha orizzontale corto
- ◀ cod. **CI07489**
Ingranaggio doppio intermedio Z=13/52 motore scooter 50 cc Minarelli/Yamaha verticale e orizzontale lungo

ALBERI USCITA MOTO



- ◀ cod. **CI07480**
Albero uscita moto Z=44 motore scooter 50 cc Minarelli/Yamaha verticale e orizzontale lungo
- ◀ cod. **CI07481**
Albero uscita moto Z=43 motore scooter 50 cc Minarelli/Yamaha verticale e orizzontale lungo



- ◀ cod. **CI07491**
Albero uscita moto per motore scooter 50 cc Piaggio/Gilera

RIFERIMENTO ORIGINALE

Piaggio	478155
---------	--------



- ◀ cod. **CI07492**
Albero uscita moto per motore scooter Piaggio/Gilera 125/150 cc

RIFERIMENTO ORIGINALE

Piaggio	478156
---------	--------

ALBERI MESSA IN MOTO



◀ cod. **CI07487**

Albero messa in moto motore scooter 50 cc Minarelli/Yamaha verticale e orizzontale lungo



◀ cod. **CI07494**

Albero messa in moto per motore scooter 50 cc Piaggio/Gilera

◀ cod. **CI07495**

Albero messa in moto per motore scooter 50 cc Peugeot



◀ cod. **CI07497**

Albero messa in moto Vespa PX 125-150-200 cc

RIFERIMENTO ORIGINALE

Piaggio	148570
---------	--------



◀ cod. **CI07498**

Albero messa in moto Vespa ET3-50PK-Primavera

RIFERIMENTO ORIGINALE

Piaggio	0789766
---------	---------

GRUPPI INGRANAGGI SECONDARI



◀ cod. **CI07450**
Coppia ingranaggi secondari
Scarabeo '96 - Carosello
Numero denti: 12/44 - Rapporto: 1:3,66

◀ cod. **CI07451**
Coppia ingranaggi secondari Minarelli/Yamaha
Flipper - Why
Numero denti: 13/43 - Rapporto: 1:3,30

◀ cod. **CI07452**
Coppia ingranaggi secondari Minarelli/Yamaha
Booster
Numero denti: 13/42 - Rapporto: 1:3,23

◀ cod. **CI07458**
Coppia ingranaggi secondari Minarelli/Yamaha
F10 Racing
Numero denti: 15/34 - Rapporto: 1:2,26

INGRANAGGI AVVIAMENTO

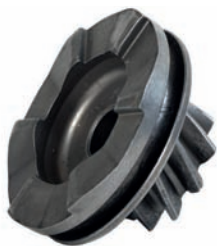

- ◀ cod. **CI07490**
Ingranaggio scorrevole messa in moto per motore scooter 50 cc Minarelli/Yamaha



- ◀ cod. **CI07493**
Ingranaggio scorrevole messa in moto per motore scooter Piaggio 50 cc



- ◀ cod. **CI07496**
Ingranaggio avviamento Vespa PX 125-150-200 cc

RIFERIMENTO ORIGINALE

Piaggio	1135264
---------	---------

CONVOGLIATORI



- ◀ cod. **CO00001**
Convogliatore per motori scooter 50 cc Minarelli/Yamaha tipo verticale
- ◀ cod. **CO00002**
Convogliatore per motori scooter 50 cc Minarelli/Yamaha tipo orizzontale corto e lungo
- ◀ cod. **CO00003**
Cuffia convogliatore per motori scooter 50 cc Minarelli/Yamaha tipo orizzontale
- ◀ cod. **CO00004**
Cuffia convogliatore per motori scooter 50 cc Minarelli/Yamaha tipo verticale



◀ cod. **CT00692**
Collettore aspirazione Ø 19 mm Vespa ET3 125-Primavera

RIFERIMENTO ORIGINALE

Piaggio	1341255
---------	---------

APPLICABILITÀ

Piaggio Vespa 125 ET3 125 2T 76-83, Vespa 125 Primavera 125 2T 67-83



◀ cod. **CT00700**
Collettore aspirazione - flangia a tre fori Ø 19mm Vespa PK XL 125

RIFERIMENTO ORIGINALE

Piaggio	2247555
---------	---------

APPLICABILITÀ

Piaggio Vespa FL 125 125 2T 89-90, Vespa PK XL 125 125 2T 86-89



◀ cod. **CT00704**
Bocchettone 50 cc Ø 19 mm Vespa 125 Primavera

RIFERIMENTO ORIGINALE

Piaggio	1125174
---------	---------

APPLICABILITÀ

Piaggio Vespa 125 ET3 125 2T 76-83, Vespa 125 Primavera 125 2T 67-83



◀ cod. **CT00694**
Collettore scarico Vespa 50/90/125 Primavera - ET3 - PK



◀ cod. **CT00725**
Collettore aspirazione motore scooter 50 cc Minarelli/Yamaha orizzontale

RIFERIMENTO ORIGINALE

Yamaha	4CUE35552000
Mbk	4CUE35552000

Malaguti	76004500
Aprilia	AP8206466



◀ cod. **CT00726**
Collettore aspirazione motore scooter 50 cc Minarelli/Yamaha verticale

RIFERIMENTO ORIGINALE

Yamaha	3VLE35552000
Mbk	3VLE35552000

Aprilia	AP8206514
---------	-----------



◀ cod. **CT00727**
Collettore aspirazione per motore scooter 50 cc Gilera/Piaggio

RIFERIMENTO ORIGINALE

Piaggio	830939
Gilera	830939

Derbi	830939
Aprilia	830939



◀ **cod. CT00728**
Collettore aspirazione per motore scooter Piaggio 125/150/180 cc

RIFERIMENTO ORIGINALE

Aprilia	AP8550171	Piaggio	430206
---------	-----------	---------	--------

APPLICABILITÀ

Aprilia	SR 125 125 2T 99-01, SR 150 150 2T 99-01	Piaggio	Hexagon 125 125 2T 94-97, Skypper 125 125 2T 94-97,
Gilera	Runner FX 125 125 2T 97-02, Typhoon 125 125 2T 95-98, Typhoon 125 X-XR 125 2T 99-00, Runner FXR 180 180 2T 97-02		Hexagon 150 150 2T 94-97, Skypper 150 150 2T 94-97, Hexagon LXT180 180 2T 98-99



◀ **cod. CT00729**
Collettore aspirazione per scooter YP 125cc '03

RIFERIMENTO ORIGINALE

Yamaha	5XME35850000	MBK	5XME35850000
--------	--------------	-----	--------------

APPLICABILITÀ

Mbk	Skyliner E 125 125 4T 03-03, Skyliner E 180 180 4T 03-03	Yamaha	Majesty 125 E 125 4T 03-09, Majesty 180 E 180 4T 03-06
------------	--	---------------	--



◀ **cod. CT00730**
Collettore aspirazione per scooter YP 125cc '02

RIFERIMENTO ORIGINALE

Yamaha	5DS135850000	Malaguti	76005500
MBK	5DS135850000		

APPLICABILITÀ

Benelli	Velvet 125 125 4T 99-01, Velvet 150 150 4T 99-01	Mbk	Doodo 125 125 4T 00-00, Flame T 125 125 4T 95-99, Skyliner 125 125 4T 98-02, Thunder 125 125 4T 01-02, Doodo 150 150 4T 01-02, Skyliner 150 150 4T 00-02, Thunder 150 150 4T 01-02
Italjet	Jupiter 125 125 4T -00, Millenium 125 125 4T -00, Jupiter 150 150 4T -00, Millenium 150 150 4T -00	Yamaha	Majesty 125 125 4T 98-02, Maxter 125 125 4T 01-02, Teo's 125 125 4T 00-00, Majesty 150 150 4T 00-02, Maxter 150 150 4T 01-02, Teo's 150 150 4T 01-02
Malaguti	Madison 125 125 4T 99-01, Madison R Restyling 125 125 4T 02-02, Phantom Max 125 125 4T 03-03, Madison T 150 150 4T 99-01		



◀ **cod. CT00732**
Collettore aspirazione - flangia due fori Ø 19mm Vespa 50 PK

RIFERIMENTO ORIGINALE

Piaggio	1787265
---------	---------

APPLICABILITÀ

Piaggio	Vespa PK 50 2T 82-84
----------------	----------------------



◀ **cod. CT00733**
Collettore aspirazione - flangia a due fori Ø 19mm Vespa PK XL 125

RIFERIMENTO ORIGINALE

Piaggio	1968125
---------	---------

APPLICABILITÀ

Piaggio	Vespa PK 125 125 2T 82-84
----------------	---------------------------



◀ **cod. CT00734**
Collettore Aspirazione Piaggio Beverly 125cc'01-'03

APPLICABILITÀ

Aprilia Atlantic 125 125 4T 03-05, Scarabeo 125 125 4T 03-06, Sportcity 125 125 4T 04-06, Atlantic 200 200 4T 03-05
Gilera DNA 125 125 4T 01-01, Runner VX 125 125 4T 00-04, DNA 180 180 4T 01-01, Runner VXR 180 180 4T 00-01, Runner VXR 200 200 4T 02-04
Piaggio Beverly 125 125 4T 01-03, Hexagon GTX 125 125 4T 00-00, Super Hexagon GTX 12 125 125 4T 01-02, Vespa GRANTURISMO 125 125 4T 03-05, X9 125 125 4T 01-02, X9 Evolution 125 125 4T 03-03, X9 Amalfi 180 180 4T 00-03, X9 200 200 4T 02-03, X9 Evolution 200 200 4T 03-03

RIFERIMENTO ORIGINALE

Aprilia	484748	Piaggio	484748
Gilera	484748		



◀ **cod. CT00735**
Collettore Aspirazione Piaggio Beverly 125/250cc'04-'07

APPLICABILITÀ

Aprilia Atlantic 250 250 4T 03-05, Scarabeo 250 250 4T 04-06 Derbi: GP1 125 EU 2 125 4T 06-06, GP1 250 250 4T 06-07
Gilera Runner 4T ST EU3 125 125 4T -, Runner VX 125 125 4T 05-06, Runner VX Race 125 125 4T 06-06, Runner VX SC 125 4T 06-07, Runner VXR Race 200 125 4T 06-06, Runner VXR 200 200 4T 05-06, Runner VXR EU3 200 200 4T 07-07, Oregon 250 250 4T 06-10
Piaggio Beverly RST 125 125 4T 04-, Vespa GRANTURISMO 125 125 4T 06-07, Vespa GRANTURISMO 125 EU3 125 4T 06-07, Vespa GTV 125 125 4T -, X8 125 125 4T 04-06, X8 125 Premium EU2 125 4T 06-06, X9 Evolution 125 125 4T 05-06, Vespa GRANTURISMO 200 200 4T 06-07, X8 200 200 4T 04-07, Beverly 250 250 4T 06-07, Beverly RST 250 250 4T 04-05, X9 Evolution 250 250 4T 04-04, X9 Evolution 250 250 4T 06-06

RIFERIMENTO ORIGINALE

Aprilia	840949	Gilera	840949
Derbi	840949	Piaggio	840949



◀ **cod. CT00736**
Collettore Aspirazione Piaggio Liberty 125/150/200cc

APPLICABILITÀ

Aprilia Mojito 125 125 4T 03-08, SR Motard 125 125 4T 2V 12-12, Sportcity One 4T EU3 125 125 4T 08-11
Derbi Boulevard 125 125 4T 03-04, Boulevard 125 EU3 125 4T 04-07, Boulevard 4T EU3 125 4T 08-12, Sonar 4T 125 125 4T 09-11, Variant Sport 4T EU3 125 4T 12-12, Boulevard 150 150 4T 03-04, Boulevard 150 EU3 150 4T 04-07, Boulevard 4T E3 150 4T 10-10, Sonar 4T 150 150 4T 09-09, Boulevard 200 200 4T
Piaggio Fly 125 125 4T 05-07, Fly 125 EU3 125 4T 07-11, Liberty 125 4T 125 4T 06-07, Liberty 125 4T EU3 Delivery - TNT 125 4T -, Liberty 125 Sport 125 4T 06-06, Liberty 4T 2V Euro3 125 4T -, Liberty RST 125 125 4T 04-05, Typhoon 125 4T 2V E3 125 4T 10-11, Vespa LX 125 125 4T 05-06, Vespa LX EU3 125 4T 06-08, Vespa LXV 4T EU3 125 4T 06-09, X8 Street 125 EU2 125 4T 06-07, Fly 150 150 4T 05-07, Fly 150 EU3 150 4T 08-11, Liberty 150 Moc 4T 150 4T 09-13, Vespa LX 150 150 4T 05-06, Vespa LX EU3 150 4T 06-08, X8 Street 150 EU2 150 4T 06-08, Liberty 200 200 4T 06-06, Liberty 200 Sport 200 4T 06-06, Liberty RST 200 200 4T 04-04

RIFERIMENTO ORIGINALE

Aprilia	849465	Piaggio	849465
Derbi	849465		



◀ **cod. CT00737**
Collettore Aspirazione Aprilia Scarabeo 50cc 4T '09

APPLICABILITÀ

Aprilia Scarabeo 4T Restyling EU3 50 4T 06-09, Sport City One 4T 50 4T 08-10
Derbi Atlantis 4T EU2 50 4T 07-07, Boulevard 4T EU2 25KM/H 50 4T
Piaggio Fly 4T 50 4T 05-07, Fly 4T & 25-30 KM/H 50 4T -, Fly 4T Motore CHN 50 4T 06-07, Liberty 4T 50 4T 05-08, Liberty 4T Delivery - Single 50 4T 10-12, Liberty 4T Delivery TNT 50 4T 09-09, Liberty 4T PTT - DOUBLE 50 4T 09-12, Liberty 4T Sport 50 4T 06-08, Liberty MOC 4T & Elle 50 4T 09-13, Vespa LX 4T 50 4T 05-08, Zip 4T 50 4T 06-13

RIFERIMENTO ORIGINALE

Aprilia	845946	Piaggio	845946
Derbi	845946		



◀ **cod. CT00738**
Collettore Aspirazione Aprilia Scarabeo 50cc 4T '06

APPLICABILITÀ

Aprilia Scarabeo 4T 50 4T 02-06
Derbi Atlantis 4T 50 4T 04-06
Piaggio Liberty 4T 50 4T 00-02, Liberty 4T RST 50 4T 04-04, Vespa ET4 50 4T 00-05, Zip 4T 50 4T 00-05

RIFERIMENTO ORIGINALE

Aprilia	969405	Piaggio	969405
Derbi	969405		



◀ cod. **CT00739**

Collettore Aspirazione Piaggio Liberty 125cc '98-'00

APPLICABILITÀ

Piaggio Liberty 125 125 4T 98-00, Sfera 125 4T 95-97, Vespa ET4 125 125 4T 96-98

RIFERIMENTO ORIGINALE

Piaggio	480799
---------	--------



◀ cod. **CT00740**

Collettore Aspirazione Piaggio Liberty 125cc '00-'02

APPLICABILITÀ

Derbi Boulevard 125 125 4T 02-02, Boulevard 150 150 4T 02-02
Piaggio Liberty 125 125 4T 01-02, Skypper 125 4T 125 4T 00-02, Vespa ET4 125 125 4T 99-02, Zip 125 125 4T 00-02, Skypper 150 4T 150 4T 00-02, Vespa ET4 150 150 4T 99-02

RIFERIMENTO ORIGINALE

Derbi	485587	Piaggio	485587
-------	--------	---------	--------



◀ cod. **CT00741**

Collettore Aspirazione Peugeot Ludix 50cc

APPLICABILITÀ

Peugeot Jet C-Tech 50 2T -00, Jet Force 50 2T -00, Ludix 50 2T -00, Ludix Blaster 50 2T -00

RIFERIMENTO ORIGINALE

Peugeot	768537
---------	--------



◀ cod. **CT00742**

Collettore Aspirazione Kymco Agility 125/150cc R16

APPLICABILITÀ

Kymco Agility 125 R16 125 4T 08-09, Super 8 125 125 4T 08-09, Agility 150 R16 150 4T 08-09

RIFERIMENTO ORIGINALE

Kymco	117091	Kymco	1711A-LEJ3-E10
-------	--------	-------	----------------



◀ cod. **CT00743**

Collettore Aspirazione Kymco Agility 50cc 4T

APPLICABILITÀ

Kymco Agility 4T R12 50 4T 07-08, Agility R12 50 4T 05-05, Agility R16 50 4T 08-09, Agility R16 50 4T 12-12, Agility RS 50 4T 09-09, Filly 50 4T 98-00, Filly LX 50 4T 01-02, Like 50 4T 09-09, People S 4T 50 4T 06-08, Super 8 4T 50 4T 07-07, Super 8 4T 50 4T 09-09, Vitality 4T 50 4T 04-04

RIFERIMENTO ORIGINALE

Kymco	117075	Kymco	1711A-LEJ2-E10
-------	--------	-------	----------------



▲
cod. **F007510**



▲
cod. **F007511**



▲
cod. **F007512**



▲
cod. **F007513**



▲
cod. **F007514**



▲
cod. **F007515**



▲
cod. **F007516**



▲
cod. **F007517**



▲
cod. **F007519**



▲
cod. **F007520**



▲
cod. **F007521**



▲
cod. **F007522**



▲
cod. **F007523**



▲
cod. **F007524**

Marca	Modello	CC	Anno	Codice
Aprilia	Atlantic 125	125	2003>2005	F007515
	Atlantic 125 EU3	125	2006>2008	F007515
	Atlantic 125 EU3	125	2010>2012	F007515
	Atlantic 200	200	2003>2005	F007515
	Atlantic 250	250	2003>2005	F007515
	Atlantic 250 EU3	250	2006>2008	F007515
	Atlantic 300	300	2010>2011	F007515
	Atlantic 500	500	2001>2004	F007524
	Atlantic Arrecife 125	125	>2000	F007515
	Atlantic Arrecife 200	200	>2000	F007515
	Atlantic Arrecife 250	250	>2000	F007515
	Atlantic Arrecife 400	400	>2000	F007524
	Atlantic Arrecife 500	500	2005>2008	F007524
	Atlantic Sprint 400	400	2005>2008	F007524
	Atlantic Sprint 500	500	2005>2008	F007524
	Leonardo 125	125	1996>1998	F007516
	Leonardo 125	125	1999>2002	F007516
	Leonardo 150	150	1996>1998	F007516
	Leonardo 150	150	1999>2002	F007516
	Leonardo ST	125	2003>2004	F007516
	Mojito 125	125	2003>2007	F007515
	Mojito 125	125	2008>2008	F007515
	Mojito 150	150	2003>2007	F007515
	Mojito Retrò Custom	125	1999>2001	F007514
	SR MAX 125	125	2011>2014	F007515
	SR MAX 300	300	2011>2014	F007515
	SR Motard 125	125	2012>2012	F007515
	Scarabeo 125	125	1999>2003	F007516
	Scarabeo 125	125	2003>2003	F007515
	Scarabeo 125	125	2004>2006	F007515
	Scarabeo 150	150	1999>2003	F007516
	Scarabeo 150	150	2004>2006	F007515
	Scarabeo 200	200	2001>2003	F007516
Scarabeo 200	200	2003>2003	F007515	
Scarabeo 250	250	2004>2006	F007515	
Scarabeo 500	500	2003>2006	F007524	
Scarabeo EU3 125	125	2006>2007	F007515	
Scarabeo EU3 200	200	2006>2007	F007515	
Scarabeo Light 250	250	2006>2008	F007515	
Scarabeo Light 300	300	2009>2010	F007515	
Scarabeo Light 400	400	2006>2008	F007524	
Scarabeo Light 500	500	2006>2008	F007524	
Sport City Street 125	125	2012>2012	F007515	

Marca	Modello	CC	Anno	Codice	
Aprilia	Sportcity 125	125	2004>2006	F007515	
	Sportcity 125 EU3	125	2006>2008	F007515	
	Sportcity 200	200	2004>2006	F007515	
	Sportcity 200 EU3	200	2006>2008	F007515	
	Sportcity 250	250	>2000	F007515	
	Sportcity 250 EU3	250	2006>2008	F007515	
	Sportcity Cube 125	125	2008>2010	F007515	
	Sportcity Cube 200	125	2008>2010	F007515	
	Sportcity Cube 250	250	2008>2012	F007515	
	Sportcity Cube 300	300	2008>2010	F007515	
	Sportcity One 4T EU3 125	125	2008>2011	F007515	
	Sport City Street 300	300	2012>2012	F007515	
	BMW	C1 125	125	2000>2003	F007516
		C1 200	200	2002>2003	F007516
	Benelli	Adiva 125	125	2001>2002	F007515
Adiva 150		150	2001>2002	F007515	
Adiva 250 EU2		250	>2000	F007515	
Velvet Dusk 400	400	2003>2004	F007510		
Beta	RR	125	2010>2010	F007523	
	Derbi	Boulevard 125	125	2002>2002	F007515
Boulevard 125		125	2003>2004	F007515	
Boulevard 125 EU3		125	2004>2007	F007515	
Boulevard 150		150	2002>2002	F007515	
Boulevard 150		150	2003>2004	F007515	
Boulevard 150 EU3		150	2004>2007	F007515	
Boulevard 200 EU2		200	2005>2006	F007515	
Boulevard 4T E3		150	2010>2010	F007515	
Boulevard 4T EU3		125	2008>2012	F007515	
GP1 125 EU 2		125	2006>2006	F007515	
GP1 250		250	2006>2007	F007515	
GP1 250 Low Seat EU3		250	2007>2008	F007515	
GP1 Low Seat EU3		125	2007>2008	F007515	
Rambla 125	125	2008>2009	F007515		
Rambla 125 EU3 2VER	125	2008>2008	F007515		
Rambla 250	250	2008>2009	F007515		
Rambla 250 EU3 2VER	250	2008>2008	F007515		
Rambla 300	300	2010>2011	F007515		
Sonar 4T 125	125	2009>2011	F007515		
Sonar 4T 150	150	2009>2009	F007515		
Variant Sport 4T EU3	125	2012>2012	F007515		
Fantic	Caballero Motard	125	2008>2008	F007523	
	Caballero Regolarità	125	2008>2008	F007523	
Gilera	DNA 125	125	2001>2001	F007515	

Marca	Modello	CC	Anno	Codice
Gilera	DNA 180	180	2001>2001	F007515
	Fuoco 4T-4V IE E3 LT	500	>2014	F007524
	Fuoco 500 IE EU3	500	2007>2013	F007524
	GP	800	2007>2008	F007524
	GP	800	2009>2011	F007524
	GP CENTENARIO	800	2009>2009	F007524
	Nexus 125 EU3	125	2007>2008	F007515
	Nexus 125 IE EU3	125	2008>2008	F007515
	Nexus 125 IE EU3	125	2009>2010	F007515
	Nexus 250 EU3	250	2006>2006	F007515
	Nexus 250 EU3	250	2007>2007	F007515
	Nexus 300 EU3	300	2008>2008	F007515
	Nexus 300 EU3	300	2009>2011	F007515
	Nexus 500	500	2003>2005	F007524
	Nexus 500 EU3	500	2006>2008	F007524
	Nexus 500 EU3	500	2009>2011	F007524
	Nexus SP 250 EU3	250	2006>2007	F007515
	Nexus SP 500 EU3	500	2006>2007	F007524
	Runner 180	180	2000>2001	F007515
	Runner 4T ST EU3 125	125	2008>2013	F007515
	Runner VX 125	125	2000>2001	F007515
	Runner VX 125	125	2002>2004	F007515
	Runner VX 125	125	2005>2006	F007515
	Runner VX 4T EU3 125	125	2006>2007	F007515
	Runner VX Race 125	125	2006>2006	F007515
	Runner VX SC	125	2006>2007	F007515
	Runner VXR 180	180	2000>2001	F007515
	Runner VXR 200	200	2002>2004	F007515
	Runner VXR 200	200	2005>2006	F007515
	Runner VXR 4T ST EU3 200	200	2008>2011	F007515
	Runner VXR EU3 200	200	2007>2007	F007515
	Runner VXR Race 200	125	2006>2006	F007515
	HM	CITY	125	2011>2013
CITY		200	2011>2013	F007523
CRE F125X		125	2008>2009	F007523
CRE F125X BAJA		125	2010>2012	F007523
CRE F125X SIX		125	2010>2011	F007523
CRM F125X		125	2008>2009	F007523
CRM F125X DERAPAGE		125	2010>2012	F007523
CRM F125X DERAPAGE COMPETITION		125	2010>2011	F007523
CRM F125X DERAPAGE RR		125	2010>2012	F007523
LOCUSTA		125	2011>2013	F007523
LOCUSTA		200	2011>2013	F007523

Marca	Modello	CC	Anno	Codice	
Honda	Forza 250 [NSS A]	250	2008>2011	F007513	
	Forza 250 [NSS S]	250	2008>2011	F007513	
	SH IE 300 Scoopy	300	2007>2010	F007513	
	SH IE 300 Scoopy	300	2011>2016	F007513	
	SW-T 400 [FJS]	400	2009>2013	F007513	
	SW-T 600 [FJS]	600	2011>2013	F007513	
	Silver Wing 400 [FJS]	400	2006>2008	F007513	
	Silver Wing 600 [FJS]	600	2001>2010	F007513	
	Husqvarna	SM	125	2010>2010	F007523
		TE	125	2010>2010	F007523
Italjet	Jet Set 125	125	>2000	F007515	
	Jet Set 150	150	>2000	F007515	
	Torpedo 125	125	>2000	F007515	
	Torpedo 150	150	>2000	F007515	
Malaguti	Madison 3 125	125	2006>2009	F007515	
	Madison 3 250	250	2006>2009	F007515	
	Madison R 180	180	2001>2002	F007515	
	Madison RS 250	250	2004>2004	F007515	
	Madison S Restyling 200	200	2002>2002	F007515	
	Phantom Max 200	200	2003>2003	F007515	
	Phantom Max 250	250	2004>2004	F007515	
	Spider Max 500 GT	500	2004>2005	F007524	
	Spider Max 500 GT EU3	500	2006>2006	F007524	
	Spider Max RS 500	500	2008>2008	F007524	
Mbk	Cityliner 125 EU3	125	2008>2010	F007523	
	Skycruiser 125	125	2007>2007	F007523	
Motorhispania	KN1	125	2008>2008	F007523	
	MH7	125	2008>2008	F007523	
	RX-R	125	2008>2008	F007523	
Peugeot	Geopolis 250 IE EU3	250	>2000	F007515	
	Geopolis 400 IE EU3	400	>2000	F007524	
	Geopolis 500 IE EU3	500	>2000	F007524	
	Satelis 250 EU3	250	>2000	F007515	
Piaggio	Satelis 400 EU3	400	>2000	F007524	
	Satelis 500 EU3	500	>2000	F007524	
	Beverly 125	125	2001>2003	F007515	
	Beverly 125 EU3	125	2007>2008	F007515	
	Beverly 125 EURO 3 MIC	125	2007>2007	F007515	
	Beverly 125 EURO 3 SPORT	125	2007>2008	F007515	
	Beverly 125 RST 4T 4V IE EU3	125	2010>2015	F007515	
	Beverly 125 Tourer EU3	125	2007>2010	F007515	
	Beverly 200	200	2001>2003	F007515	
	Beverly 250	250	2006>2007	F007515	

Marca	Modello	CC	Anno	Codice
Piaggio	Beverly 250 CRUISER	250	2007>2009	F007515
	Beverly 250 EURO 3 MIC	250	2007>2007	F007515
	Beverly 250 SPORT	250	2006>2008	F007515
	Beverly 250 Tourer EU3	250	2007>2009	F007515
	Beverly 250 ie EU3	250	2006>2008	F007515
	Beverly 300 RST 4T 4V IE EU3	300	2010>2015	F007515
	Beverly 400 EU3	400	2006>2007	F007524
	Beverly 500	500	2002>2004	F007524
	Beverly 500	500	2005>2006	F007524
	Beverly 500 ie EU3	500	2006>2008	F007524
	Beverly Cruiser	500	2007>2012	F007524
	Beverly RST 125	125	2004>2005	F007515
	Beverly RST 125	125	2005>2007	F007515
	Beverly RST 250	250	2004>2005	F007515
	Beverly Tourer 300 EU3	300	2009>2010	F007515
	Beverly Tourer 400 EU3	400	2008>2010	F007524
	Carnaby 125	125	2007>2010	F007515
	Carnaby 200	200	2007>2008	F007515
	Carnaby 250	250	2008>2008	F007515
	Carnaby Cruiser 300	300	2009>2012	F007515
	Fly 125	125	2005>2007	F007515
	Fly 125 EU3	125	2007>2007	F007515
	Fly 125 EU3	125	2008>2011	F007515
	Fly 150	150	2005>2007	F007515
	Fly 150 EU3	150	2008>2011	F007515
	Hexagon GTX 125	125	2000>2000	F007515
	Hexagon GTX 180	180	2000>2000	F007515
	Hexagon LX4 125	125	1998>1999	F007514
	Liberty 125	125	1998>2000	F007514
	Liberty 125	125	2001>2002	F007515
	Liberty 125 4T	125	2006>2007	F007515
	Liberty 125 4T EU3	125	2007>2008	F007515
	Liberty 125 4T EU3 Delivery - TNT	125	2008>2015	F007515
	Liberty 125 4T Sport EU3	125	2006>2008	F007515
	Liberty 125 Sport	125	2006>2006	F007515
	Liberty 150	150	2001>2002	F007515
	Liberty 150 4T Sport EU3	150	2008>2008	F007515
	Liberty 150 Moc 4T	150	2009>2013	F007515
	Liberty 200	200	2006>2006	F007515
	Liberty 200 4T EU3	200	2006>2008	F007515
	Liberty 200 4T Sport EU3	200	2006>2007	F007515
	Liberty 200 Sport	200	2006>2006	F007515
	Liberty 4T 2V Euro3	125	2009>2012	F007515

Marca	Modello	CC	Anno	Codice
Piaggio	Liberty RST 125	125	2004>2005	F007515
	Liberty RST 200	200	2004>2004	F007515
	Liberty RST PTT 125	125	2005>2011	F007515
	MP3 125	125	2006>2008	F007515
	MP3 125 IE	125	2008>2009	F007515
	MP3 125 IE Touring	125	2011>2012	F007515
	MP3 125 Ibrido	125	2009>2010	F007515
	MP3 125 Yourban ERL	125	2011>2011	F007515
	MP3 250	250	2006>2008	F007515
	MP3 250 LT	250	2008>2009	F007515
	MP3 250 MIC	250	2008>2009	F007515
	MP3 300 4T 4V IE LT Ibrido	300	2010>2011	F007515
	MP3 300 IE LT	300	2010>2011	F007515
	MP3 300 IE LT Touring	300	2011>2013	F007515
	MP3 300 IE LT/Sport	300	2011>2014	F007515
	MP3 300 IE MIC	300	2010>2010	F007515
	MP3 300 IE MIC	300	2011>2011	F007515
	MP3 300 IE Touring	300	2011>2012	F007515
	MP3 300 Yourban ERL	300	2011>2015	F007515
	MP3 300 Yourban LT ERL	300	2011>2012	F007515
	MP3 400	400	2007>2008	F007524
	MP3 400 IE LT Touring	400	2011>2011	F007524
	MP3 400 IE LT/Sport	400	2008>2010	F007524
	MP3 400 MIC	400	2008>2010	F007524
	MP3 400 RL Touring	400	2011>2011	F007524
	MP3 LT Business ABS	500	2014>2016	F007524
	MP3 LT Sport-Business	500	2011>2013	F007524
	MP3 RL Sport-Business	500	2011>2012	F007524
	MP3 Sport ABS	500	2014>2015	F007524
	Sfera	125	1995>1997	F007514
	Skypper 125 4T	125	2000>2002	F007515
	Skypper 150 4T	150	2000>2002	F007515
	Super Hexagon GTX 12 125	125	2001>2002	F007515
	Super Hexagon GTX 12 180	180	2001>2002	F007515
	Typhoon 125 4T 2V E3	125	2010>2011	F007515
	Vespa ET4 125	125	1996>1998	F007514
	Vespa ET4 125	125	1999>2002	F007515
	Vespa ET4 150	150	1999>2002	F007515
	Vespa GRANTURISMO 125	125	2003>2005	F007515
	Vespa GRANTURISMO 125	125	2006>2007	F007515
	Vespa GRANTURISMO 125 EU3	125	2006>2007	F007515
	Vespa GRANTURISMO 200	200	2003>2005	F007515
	Vespa GRANTURISMO 200	200	2006>2007	F007515

Marca	Modello	CC	Anno	Codice
Piaggio	Vespa GT 60 250 EU3	250	2006>2007	F007515
	Vespa GTS 125 EU3	125	2007>2012	F007515
	Vespa GTS 250	250	2005>2016	F007515
	Vespa GTS 4T IE SUPER	125	2009>2016	F007515
	Vespa GTS ABS 250	250	2005>2012	F007515
	Vespa GTS IE Touring 300	300	2011>2012	F007515
	Vespa GTS Super	300	2008>2015	F007515
	Vespa GTS Super Sport	300	2010>2013	F007515
	Vespa GTV 125	125	2006>2008	F007515
	Vespa GTV 250	250	2006>2009	F007515
	Vespa GTV 4T 4V IE 300	300	2010>2013	F007515
	Vespa GTV 4T NAVY EU3 125	125	2008>2008	F007515
	Vespa GTV 4T NAVY EU3 250	250	2007>2007	F007515
	Vespa GTV VIA MONTENAPOLEONE	300	2010>2010	F007515
	Vespa LX 125	125	2005>2006	F007515
	Vespa LX 150	150	2005>2006	F007515
	Vespa LX 4T EU3 TOURING	125	2010>2011	F007515
	Vespa LX 4T FL	125	2009>2009	F007515
	Vespa LX 4T FL	150	2009>2009	F007515
	Vespa LX EU3	125	2006>2008	F007515
	Vespa LX EU3	150	2006>2008	F007515
	Vespa LX EU3 IE	125	2009>2010	F007515
	Vespa LX EU3 IE	150	2009>2011	F007515
	Vespa LX TOURING	150	2010>2012	F007515
	Vespa LXV 4T EU3	125	2006>2009	F007515
	Vespa LXV IE 4T	125	2010>2012	F007515
	Vespa LXV NAVY EU3	125	2007>2008	F007515
	Vespa S 4T 125 EU3	125	2007>2008	F007515
	Vespa S 4T 150	150	2008>2009	F007515
	Vespa S 4T IE & COLLEGE	125	2009>2011	F007515
	Vespa S 4T IE & COLLEGE	150	2009>2011	F007515
	X-Evo 125	125	2007>2016	F007515
	X-Evo 250	250	2007>2016	F007515
	X-Evo 400	400	2007>2011	F007524
	X7 125 EU3	125	2008>2008	F007515
	X7 250 EU3	250	2008>2008	F007515
	X7 Evo 125 IE EU3	125	2009>2010	F007515
	X7 Evo 300 IE EU3	300	2009>2010	F007515
	X8 125	125	2004>2004	F007515
	X8 125	125	2005>2006	F007515
	X8 125 Premium EU2	125	2006>2006	F007515
	X8 125 Premium EU3	125	2006>2007	F007515
	X8 200	200	2004>2004	F007515

Marca	Modello	CC	Anno	Codice	
Piaggio	X8 200	200	2005>2007	F007515	
	X8 250 EU3	250	2005>2008	F007515	
	X8 400 EU3	400	2006>2008	F007524	
	X8 Street 125 EU2	125	2006>2007	F007515	
	X8 Street 150 EU2	150	2006>2008	F007515	
	X9 125	125	2001>2002	F007515	
	X9 200	200	2002>2003	F007515	
	X9 500	500	2001>2002	F007524	
	X9 Amalfi 180	180	2000>2003	F007515	
	X9 Evolution 125	125	2003>2003	F007515	
	X9 Evolution 125	125	2005>2006	F007515	
	X9 Evolution 200	200	2003>2003	F007515	
	X9 Evolution 250	250	2004>2004	F007515	
	X9 Evolution 250	250	2006>2006	F007515	
	X9 Evolution 500	500	2003>2005	F007524	
	X9 Evolution 500	500	2006>2007	F007524	
	X9 Evolution ABS 500	500	2006>2007	F007524	
	X9 Evolution EU3 125	125	2007>2007	F007515	
	Zip 125	125	2000>2002	F007515	
	Renault	Fulltime 125	125	>2000	F007515
		Rieju	Marathon	125	2009>2009
	Marathon Pro		125	2009>2009	F007523
	Marathon Pro Competition		125	2011>2011	F007523
	RS3		125	2011>2011	F007523
	Suzuki	AN Burgman 250 K3/K6	250	2003>2006	F007510
		AN Burgman 250 W/K2	250	1998>2002	F007510
		AN Burgman 400 K3/K6	400	2003>2006	F007510
		AN Burgman 400 K7/L0	400	2007>2010	F007522
		AN Burgman 400 L1	400	2011>2011	F007522
		AN Burgman 400 X/K2	400	1999>2002	F007510
		AN Burgman 650 K3-K5	650	2003>2005	F007511
		AN Burgman 400 L2	400	2012>2012	F007522
		AN Burgman 400 L3	400	2013>2013	F007522
		AN Burgman 400 L4	400	2014>2014	F007522
		AN Burgman 400 L5	400	2015>2015	F007522
		AN Burgman 400 L6	400	2016>2016	F007522
		AN S-Y 125	125	1995>2000	F007522
		AN T-Y 150	150	1996>2000	F007522
	Epicuro 125	125	1999>2001	F007522	
	Epicuro 150	150	1999>2001	F007522	
	LT-A Kingquad K6/K7	700	2006>2007	F007511	
	LT-A Kingquad X L2	500	2012>2012	F007511	

Marca	Modello	CC	Anno	Codice	
Suzuki	LT-A Kingquad XP K9/L0	500	2009>2010	F007511	
	LT-A Kingquad XP L1	500	2011>2011	F007511	
	LT-A Kingquad XP L2	500	2012>2012	F007511	
	LT-A X KingQuad K8/L0	750	2008>2010	F007511	
	LT-A X KingQuad L1	750	2011>2011	F007511	
	LT-A X KingQuad L2	750	2012>2012	F007511	
	LT-A XP KingQuad K9/L0	750	2009>2010	F007511	
	LT-A XP KingQuad L1	750	2011>2011	F007511	
	LT-A XP KingQuad L2	750	2012>2012	F007511	
	LT-A400F Kingquad 4x4 K8/L0	400	2008>2010	F007511	
	LT-A400F Kingquad 4x4 L1	400	2011>2011	F007511	
	LT-A450F Kingquad 4x4 K7/L0	450	2007>2010	F007511	
	LT-A500F Vinson K4/K7	500	2004>2007	F007511	
	LT-Z Quadsport K7/L0	90	2007>2010	F007522	
	UE CT 125 K1	125	2001>2001	F007522	
	UE CT 150 K1	150	2001>2001	F007522	
	UH Burgman 125 K2/K6	125	2002>2006	F007522	
	UH Burgman 125 K7/L0	125	2007>2010	F007522	
	UH Burgman 125 L1	125	2011>2011	F007522	
	UH Burgman 150 K2/K6	150	2002>2006	F007522	
	UH Burgman 200 K7/L0	200	2007>2010	F007522	
	UH Burgman 200 L1	200	2011>2012	F007522	
	UX Sixteen 125 K8/L0	125	2008>2010	F007522	
	UX Sixteen 125 L1	125	2011>2011	F007522	
	UX Sixteen 150 K8/L0	150	2008>2010	F007522	
	UX Sixteen 150 L1	150	2011>2011	F007522	
	Yamaha	MT 125	125	2015>2015	F007523
		MT 125 A	125	2015>2015	F007523
		Majesty 400	400	2004>2005	F007521
		Majesty 400	400	2006>2006	F007521
Majesty 400		400	2007>2008	F007521	
Majesty 400		400	2009>2011	F007521	
Majesty 400 ABS		400	2007>2007	F007521	
Majesty 400 ABS		400	2008>2008	F007521	
Majesty 400 ABS		400	2009>2011	F007521	
T-Max 485 500		500	2009>2011	F007517	
T-Max 485 ABS 500		500	2008>2011	F007517	
T-Max 59C 530		530	2012>2012	F007517	
T-Max 59C 530		530	2013>2014	F007517	
T-Max 59C 530		530	2015>2016	F007517	
T-Max 59C 530 ABS		530	2012>2012	F007517	
T-Max 59C 530 ABS		530	2013>2014	F007517	
T-Max 59C 530 ABS		530	2015>2016	F007517	

Marca	Modello	CC	Anno	Codice
Yamaha	T-Max 59C 530 SP	530	2015>2015	F007517
	T-Max 59C 530 SP ABS	530	2015>2016	F007517
	T-Max 5GJ 500	500	2001>2003	F007517
	T-Max 5VU 500	500	2004>2005	F007517
	T-Max 5VU 500	500	2006>2006	F007517
	T-Max 5VU 500	500	2007>2007	F007517
	T-Max 5VU 500	500	2008>2008	F007517
	T-Max 5VU ABS 500	500	2005>2005	F007517
	T-Max 5VU ABS 500	500	2006>2006	F007517
	T-Max 5VU ABS 500	500	2007>2007	F007517
	T-Max 5VU BLACK MAX	500	2006>2006	F007517
	T-Max 5VU BLACK MAX - NIGHT MAX	500	2007>2007	F007517
	WR-R IE	125	2009>2011	F007523
	WR-X IE	125	2009>2011	F007523
	WR-X IE	125	2013>2014	F007523
	X-City 125 EU3	125	2008>2011	F007523
	X-MAX	400	2015>2016	F007521
	X-MAX ABS	400	2014>2014	F007521
	X-MAX ABS	400	2015>2016	F007521
	X-MAX IRONMAX ABS	400	2016>2016	F007521
	X-MAX MOMODESIGN	400	2014>2014	F007521
	X-MAX MOMODESIGN ABS	400	2014>2014	F007521
	X-Max R 125	125	2006>2007	F007523
	X-Max R 125	125	2008>2009	F007523
	X-Max R 125	125	2010>2012	F007523
	X-Max R 125	125	2012>2013	F007523
	X-Max R 125	125	2014>2014	F007523
	X-Max R 125	125	2015>2016	F007523
	X-Max R 125 ABS	125	2011>2011	F007523
	X-Max RA 125 ABS	125	2013>2013	F007523
	X-Max RA 125 ABS	125	2014>2015	F007523
	X-Max RA 125 ABS	125	2016>2016	F007523
	XT 660 R	600	2004>2005	F007519
	YZF-R A IE	125	2015>2015	F007523
	YZF-R IE	125	2008>2011	F007523
	YZF-R IE	125	2012>2012	F007523
	YZF-R IE	125	2013>2013	F007523
	YZF-R IE	125	2014>2014	F007523
	YZF-R IE	125	2015>2015	F007523
	YZF-R6	600	2001>2002	F007520



- ◀ cod. **FZ00363**
Frizione tipo originale per motore scooter 50 cc Morini/Suzuki ad aria



- ◀ cod. **FZ00364**
Frizione tipo originale per motore scooter 50 cc Piaggio/Honda

RIFERIMENTO ORIGINALE

Piaggio	CM1002045
---------	-----------



- ◀ cod. **FZ00365**
Frizione per motori scooter 50 cc Minarelli/Yamaha 3 ceppi con campana ø interno 107 mm



- ◀ cod. **FZ00366**
Frizione completa per motori scooter 50 cc Minarelli/Yamaha 2 ceppi con campana ø interno 105 mm

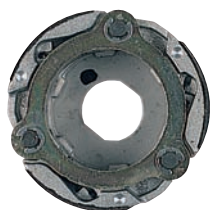

- ◀ cod. **FZ00371**
Frizione tipo originale per motore scooter Minarelli/Yamaha 125cc

RIFERIMENTO ORIGINALE

Yamaha	5DSE66200000
Mbk	5DSE66200000

Malaguti	73503300
----------	----------

APPLICABILITÀ

Italjet	Jupiter 125 125 4T -00, Millenium 125 125 4T -00
Malaguti	Madison 125 125 4T 99-01, Madison R Restyling 125 125 4T 02-02, Madison R Restyling 125 EU2 125 4T 03-04, Phantom Max 125 125 4T 03-03
MBK	Dodo 125 125 4T 00-00, Skyliner 125 125 4T 98-02, Skyliner E 125 125 4T 03-03, Thunder 125 125 4T 01-02

Yamaha	Cygnus X 125 (NXC) 125 4T 04-06, Cygnus X 125 ie EU3 (NXC) 125 4T 07-11, Majesty 125 125 4T 98-02, Majesty 125 E 125 4T 03-09, Maxter 125 125 4T 01-02, Teo's 125 125 4T 00-00
---------------	--



◀ cod. FZ00378

Frizione tipo originale per motore scooter 125/150/180 4T Piaggio

RIFERIMENTO ORIGINALE

Piaggio	CM161202
Aprilia	CM161202
Gilera	CM161202

Derbi	CM161202
Malaguti	43500800

APPLICABILITÀ

Aprilia Atlantic Arrecife 125 125 4T -00, Atlantic 200 200 4T 03-05, Atlantic Arrecife 200 200 4T -00, Sportcity 200 200 4T 04-06

Gilera Runner VX 125 125 4T 00-06, Runner 180 180 4T 00-01, Runner VXR 180 180 4T 00-01

Malaguti Madison 3 125 125 4T 06-09, Madison S Restyling 200 200 4T 02-02, Phantom Max 200 200 4T 03-03

Piaggio Fly 125 125 4T 05-07, Fly 150 150 4T 05-07, Liberty 150 150 4T 01-02, Skypper 150 4T 150 4T 00-02, Vespa ET4 150 150 4T 99-02, Hexagon GTX 180 180 4T 00-00, Super Hexagon GTX 12 180 180 4T 01-02, X9 Amalfi 180 180 4T 00-03, Carnaby 200 200 4T 07-08, Liberty 200 200 4T 06-06, Vespa GRANTURISMO 200 200 4T 03-05, Vespa GTS 200 EU3 200 4T -00, Vespa GTV 200 EU3 200 4T -00, X8 200 200 4T 04-04

Renault Fulltime 125 125 4T -00



◀ cod. FZ00382

Frizione completa per motore scooter Piaggio Beverly 250 cc 4T

RIFERIMENTO ORIGINALE

Piaggio	8722515
Aprilia	8722515
Gilera	8722515

Derbi	8722515
Malaguti	43500700

APPLICABILITÀ

Aprilia Atlantic 250 EU3 250 4T 06-08, Atlantic Arrecife 250 250 4T -00, Scarabeo 250 250 4T 04-06, Sportcity 250 250 4T -00, Sportcity 250 EU3 250 4T 06-08

Derbi GP1 250 250 4T 06-07

Gilera Nexus 250 EU3 250 4T 06-07

Malaguti Madison 3 250 250 4T 06-09, Madison RS 250 250 4T 04-04, Phantom Max 250 250 4T 04-04

Piaggio Beverly 250 250 4T 06-07, Carnaby 250 250 4T 08-08, MP3 250 250 4T 06-08, MP3 250 LT 250 4T 08-09, MP3 250 MIC 250 4T 08-09, Vespa GT 60 250 EU3 250 4T 06-07, Vespa GTS 250 250 4T 05-16, Vespa GTS ABS 250 250 4T 05-12, Vespa GTV 250 250 4T 06-09, X-Evo 250 250 4T 07-16, X8 250 EU3 250 4T 05-08, MP3 300 4T 4V IE LT Ibrido 300 4T 10-11, MP3 300 IE LT 300 4T 10-11, MP3 300 IE LT Touring 300 4T 11-13, MP3 300 IE LT/Sport 300 4T 11-14, MP3 300 IE MIC 300 4T 10-11, MP3 300 IE Touring 300 4T 11-12, MP3 300 Yourban ERL 300 4T 11-15, MP3 300 Yourban LT ERL 300 4T 11-12



◀ cod. FZ00383

Frizione completa per motore scooter Piaggio Beverly 500 cc 4T

RIFERIMENTO ORIGINALE

Piaggio	8405775
Aprilia	8405775

Gilera	8405775
Malaguti	43500500

APPLICABILITÀ

Aprilia Atlantic 500 500 4T 01-04, Scarabeo 500 500 4T 03-06

Gilera Nexus 500 500 4T 03-05

Malaguti Spider Max 500 GT 500 4T 04-05, Spider Max 500 GT EU3 500 4T 06-06, Spider Max RS 500 500 4T 08-08

Peugeot Geopolis 400 IE EU3 400 4T-4V -00, Satelis 400 EU3 400 4T -00, Geopolis 500 IE EU3 500 4T-4V -00, Satelis 500 EU3 500 4T -00

Piaggio Beverly 500 500 4T 02-06, Beverly 500 ie EU3 500 4T 06-08, Beverly Cruiser 500 500 4T 07-11, X9 500 500 4T 01-02, X9 Evolution 500 500 4T 03-07



◀ cod. FZ00385

Frizione completa per motore scooter 50 cc Piaggio Pure Jet

RIFERIMENTO ORIGINALE

Piaggio	CM1002045
---------	-----------



◀ cod. **FZ00386**
Frizione completa per Honda SH 125/150 cc

RIFERIMENTO ORIGINALE

Honda	22300KGF912
Honda	22300KGG911

Malaguti	65044700
Keeway	200203160000

APPLICABILITÀ

Honda @ [NES] 125 125 4T 00-06, Dylan 125 [SES] 125 4T 02-04, PS I 125 [PES] 125 4T 06-10, SH 125 125 4T-2V 01-04, SH IE 125 Scoopy 125 4T-2V 05-12, Silver Wing 125 [FES] 125 4T-2V 07-12, @ [NES] 150 150 4T 00-06, Dylan 150 [SES] 150 4T 02-04, PS I 150 [PES] 150 4T 06-10, Pantheon 150 IE [FES] 150 4T-2V 03-05, SH 150 150 4T-2V 01-04, SH IE 150 Scoopy 150 4T 05-12, Silver Wing 150 [FES] 150 4T-2V 07-12

Keeway Outlook 125 125 4T 07-08, Outlook 150 150 4T 07-08

Kymco Agility 125 125 4T 06-06, Agility 125 EU3 125 4T 06-08, Agility 125 R16 125 4T 08-09, Agility 125 RS 125 4T 09-09, Agility Plus 125 4T 14-14, Agility R16 125 4T 12-12, Heroism 125 4T 95-97, K-XCT I 125 4T 12-14, Like 125 125 4T 09-09, Movie 125 125 4T 99-00, Movie 125 EU3 125 4T 06-07, Movie XL 125 125 4T 01-01, Movie XL 125 EU2 125 4T 03-04, People 125 125 4T 99-00, People 125 EU2 125 4T 03-03, People 125 EU3 125 4T 07-08, People EU3 125 4T 11-11,

People ONE I 125 4T 13-13, People S 125 125 4T 05-05, People S DD EU3 125 125 4T 07-08, Super 8 125 125 4T 08-09, Vivio 125 125 4T 00-00, Agility 150 R16 150 4T 08-09, Heroism 150 150 4T 95-97, Movie 150 EU3 150 4T 06-07, Movie XL 150 150 4T 01-01, Movie XL 150 EU2 150 4T 03-04, People 150 150 4T 99-00, People 150 EU2 150 4T 03-03, Vivio 150 150 4T 00-00, Agility 200I R16 200 4T 10-10, Agility I Plus 200 4T 14-14, Agility R16 200 4T 12-12, Like 200 IE 200 4T 09-09, Like LX 200 4T 12-12, People S 200 200 4T 05-05, People S 200 I 200 4T 07-07

Malaguti Blog 125 IE 125 4T 09-10, Centro 125 IE EU3 125 4T 08-09, Centro SL 125 IE EU3 125 4T 09-10, Ciak Master 125 125 4T 04-04, Ciak Master 150 150 4T 04-04, Blog 160 IE 160 4T 09-10, Centro 160 IE EU3 160 4T 08-09, Centro SL 160 IE EU3 160 4T 09-10, Ciak Master 200 EU2 200 4T 06-06

WT Motors Atene 150 150 4T -00



◀ cod. **FZ00388**
Frizione completa Yamaha Majesty 250 cc STD type

RIFERIMENTO ORIGINALE

Yamaha	5GM166200100
Mbk	5GM166200100
Aprilia	AP8122452

Malaguti	73504300
Sym	22300HMB300

APPLICABILITÀ

Aprilia Leonardo 250 250 4T 02-04, Leonardo 300 300 4T 02-04

Italjet Jupiter 250 250 4T 00-00

Malaguti Madison S 250 250 4T 99-01, Password 250 250 4T 05-06, Password 250 EU3 250 4T 07-08

Mbk Skyliner 250 250 4T 00-03, Skyliner 250 ABS 250 4T 03-03, Kilibre 300 300 4T 03-06

Sym GTS 250 250 4T-4V 07-08, JoyMax 250 250 4T-4V 05-07, Citycon 300 300 4T-4V 08-09, JoyMax EVO 300 300 4T-4V 09-09

TGB X Motion 250 250 4T-4V 08-09

Yamaha Majesty 250 250 4T 00-03, Majesty 250 ABS 250 4T 03-03, X-City 250 250 4T 07-12, X-Max 250 250 4T 05-12, Versity 300 300 4T 03-06



◀ cod. **FZ00390**
Frizione completa Honda Foresight 250 cc

RIFERIMENTO ORIGINALE

Honda	22535KFG000
-------	-------------

APPLICABILITÀ

Honda Foresight 250 [FES] 250 4T 98-99, Foresight 250 [FES] D.D. 250 4T 00-05

Piaggio X9 250 250 4T 00-01



◀ cod. **FZ00392**
Frizione completa Honda SH 300 cc

RIFERIMENTO ORIGINALE

Honda	22300KTW902
-------	-------------

APPLICABILITÀ

Honda SH IE 300 Scoopy 300 4T-4V 07-16



◀ cod. **FZ00394**
Frizione completa 5 ceppi Yamaha Majesty 400 cc

RIFERIMENTO ORIGINALE

Yamaha	5RU166202000
--------	--------------

APPLICABILITÀ

Yamaha Majesty 400 400 4T 04-11, Majesty 400 ABS 400 4T 07-11, X-MAX 400 4T-4V 15-16, X-MAX ABS 400 4T-4V 14-16, X-MAX IRONMAX ABS 400 4T-4V 16-16, X-MAX MOMODESIGN 400 4T-4V 14-14, X-MAX MOMODESIGN ABS 400 4T-4V 14-14

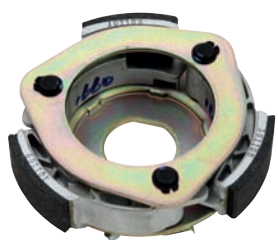

◀ cod. **FZ00396**
Frizione completa Piaggio Beverly 125 cc

RIFERIMENTO ORIGINALE

Piaggio	CM161202
---------	----------

APPLICABILITÀ

Aprilia Atlantic 125 125 4T 03-05, Atlantic 125 EU3 125 4T 06-08, Atlantic 125 EU3 125 4T 10-12, Mojito 125 125 4T 03-08, Scarabeo 125 125 4T 03-06, Scarabeo EU3 125 125 4T 06-07, Sportcity 125 125 4T 04-06, Sportcity 125 EU3 125 4T 06-08, Sportcity Cube 125 125 4T 08-10, Sportcity One 4T EU3 125 125 4T 08-11

Derbi Boulevard 125 125 4T 02-04, Boulevard 125 EU3 125 4T 04-07, Boulevard 4T EU3 125 4T 08-12, GP1 125 EU 2 125 4T 06-06, GP1 Low Seat EU3 125 4T 07-08, Rambla 125 125 4T 08-09, Boulevard 150 150 4T 02-04, Boulevard 150 EU3 150 4T 04-07

Gilera DNA 125 125 4T 01-01, Nexus 125 EU3 125 4T 07-08, Nexus 125 IE EU3 125 4T 08-10

Piaggio Beverly 125 125 4T 01-03, Beverly 125 EU3 125 4T 07-08, Beverly 125 Tourer EU3 125 4T 07-10, Beverly RST 125 125 4T 04-07, Camaby 125 125 4T 07-10, Hexagon GTX 125 125 4T 00-00, Liberty 125 125 4T 98-02, MP3 125 125 4T 06-08, MP3 125 IE 125 4T 08-09, MP3 125 Ibrido 125 4T 09-10, Skypper 125 4T 125 4T 00-02, Super Hexagon GTX 12 125 125 4T 01-02, Vespa ET4 125 125 4T 99-02, Vespa GRANTURISMO 125 125 4T 03-07, Vespa GRANTURISMO 125 EU3 125 4T 06-07, Vespa GTS 125 EU3 125 4T 07-12, Vespa GTS 4T IE SUPER 125 4T 09-16, Vespa GTV 125 125 4T 06-08, Vespa GTV 4T NAVY EU3 125 125 4T 08-08, X-Evo 125 125 4T 07-16, X7 125 EU3 125 4T 08-08, X7 Evo 125 IE EU3 125 4T 09-10, X8 125 125 4T 04-06, X9 125 125 4T 01-02, Zip 125 125 4T 00-02



◀ cod. **FZ00400**
Frizione Kymco Xciting 300 cc

RIFERIMENTO ORIGINALE

Kymco	00127965
-------	----------

APPLICABILITÀ

Kymco B&W 250 250 4T 00-00, B&W 250 EU2 250 4T 03-03, Grand Dink 250 250 4T 01-02, Grand Dink 250 EU2 250 4T 03-04, People LC 250 250 4T 03-04, People S 250 250 4T 06-06, People S 250 I 250 4T 07-07, Xciting 250 250 4T 05-05, Xciting 250 I 250 4T 06-07, Yup 250 250 4T 03-03, People S 300 I 300 4T 08-08, Xciting 300 I 300 4T 08-08, Xciting R 300i 300 4T 08-09

◀ cod. **FZ00401**
Frizione Yamaha X-Max 125 cc

RIFERIMENTO ORIGINALE

Yamaha	1B9E66200200
Yamaha	5CG166200100
Yamaha	5KDE66200000

Mbk	5KDE66200000
Mbk	5CG166200100
Malaguti	73503600

APPLICABILITÀ

Aprilia Leonardo 250 250 4T 99-01, Leonardo 250 ST 250 4T 01-01

Italjet Jupiter 150 150 4T -00, Millenium 150 150 4T -00, Jupiter 250 250 4T -00

Malaguti Madison T 150 150 4T 99-01

Mbk Skycruiser 125 125 4T-4V 07-07, Doodo 150 150 4T 01-02, Skyliner 150 150 4T 00-02, Thunder 150 150 4T 01-02, Skyliner E 180 180 4T 03-03

Yamaha X-City 125 EU3 125 4T-4V 08-11, X-Max R 125 125 4T-4V 06-16, X-Max R 125 ABS 125 4T-4V 11-11, X-Max RA 125 ABS 125 4T-4V 13-16, Majesty 150 150 4T 00-02, Maxter 150 150 4T 01-02, Teo's 150 150 4T 01-02, Majesty 180 E 180 4T 03-06, Majesty 250 250 4T 96-98, Majesty 250 DX 250 4T 98-99



◀ cod. **FZ00403**
Frizione Suzuki Burgman 400cc X-K2 / K3-K6

RIFERIMENTO ORIGINALE

Suzuki	21501-15F01-000
--------	-----------------

APPLICABILITÀ

Suzuki AN Burgman 400 K3/K6 400 4T 03-06, AN Burgman 400 X/K2 400 4T 99-02



◀ cod. **FZ00405**
Frizione Honda Vision 110cc

APPLICABILITÀ

Honda Vision 110 [NSC] 110 4T-2V 12-12



◀ cod. **FZ00407**
Frizione Honda PCX 125cc

APPLICABILITÀ

Honda PCX 125 125 4T-2V 10-13



◀ cod. **FZ00409**
Frizione Kymco DOWNTOWN 200/300cc

RIFERIMENTO ORIGINALE

Kymco	122241
Kymco	22300-LGE5-E00

APPLICABILITÀ

Kymco DOWNTOWN I 200 200 4T 10-10, People GTI 200 200 4T 10-10, DOWNTOWN 300I 300 4T 09-09, DOWNTOWN ABS 300 300 4T 10-10, DOWNTOWN I 300 300 4T 11-11, DOWNTOWN I ABS 300 300 4T 11-11, People GTI 300 300 4T 10-11



◀ cod. **FZ00411**
Frizione completa Ø 130 Kymco DOWNTOWN 125cc

RIFERIMENTO ORIGINALE

Kymco	122170
-------	--------

APPLICABILITÀ

Kymco DOWNTOWN 125 I 125 4T 09-09



◀ cod. **FZ00413**
Frizione Suzuki Burgman 125cc K7-L3

APPLICABILITÀ

Suzuki UH Burgman 125 K7/LO 125 4T 07-10, UH Burgman 125 L1 125 4T 11-11, UH Burgman 125 L3 125 4T 13-13, UX Sixteen 125 K8/LO 125 4T 08-10, UX Sixteen 125 L1 125 4T 11-11

RIFERIMENTO ORIGINALE

Suzuki	21501-46G10-000
--------	-----------------



◀ cod. **FZ00414**
Frizione Suzuki Burgman 200cc k7-L4

APPLICABILITÀ

Suzuki UH Burgman 200 K7/LO 200 4T 07-10, UH Burgman 200 L1 200 4T 11-12

RIFERIMENTO ORIGINALE

Suzuki	21501-03H30-000
--------	-----------------



◀ cod. **FZ00417**
Frizione Sym Symphony 125/150cc

RIFERIMENTO ORIGINALE

Sym	22300F6A000
-----	-------------

APPLICABILITÀ

Sym Fiddle II 125 125 4T 10-10, Jet 4 125 125 4T 09-10, Symphony 125 125 4T 09-09, Symphony S 125 125 4T 09-10, Symphony SR 125 125 4T 10-10, Fiddle II 150 150 4T 10-10, Symphony 150 150 4T 09-09, Symphony S 150 150 4T 10-10, Symphony SR 150 150 4T 10-10



◀ cod. **FZ00418**
Frizione Piaggio Liberty 125cc EU3

RIFERIMENTO ORIGINALE

Piaggio	CM1612015
---------	-----------

APPLICABILITÀ

Aprilia SR Motard 125 125 4T-2V 12-12, Sportcity One 4T EU3 125 125 4T 08-11, Derbi: Boulevard 4T EU3 125 4T 08-12, Sonar 4T 125 125 4T 09-11, Variant Sport 4T EU3 125 4T 12-12, Boulevard 4T E3 150 4T 10-10, Sonar 4T 150 150 4T 09-09

Piaggio Fly 125 125 4T 05-07, Fly 125 EU3 125 4T 07-07, Liberty 125 4T EU3 125 4T 07-08, Typhoon 125 4T 2V E3 125 4T 10-11, Vespa LX 4T EU3 TOURING 125 4T 10-11, Vespa LXV IE 4T 125 4T 10-12, Vespa S 4T 125 EU3 125 4T 07-08, Vespa S 4T IE & COLLEGE 125 4T 09-11, X8 Street 125 EU2 125 4T 06-07, Fly 150 150 4T 05-07, Fly 150 EU3 150 4T 08-11, Liberty 150 Moc 4T 150 4T 09-13, Vespa LX EU3 IE 150 4T 09-11, Vespa LX TOURING 150 4T -, Vespa S 4T 150 150 4T 08-09, X8 Street 150 EU2 150 4T 06-08



◀ cod. **FZ00419**
Frizione Suzuki Burgman 400cc K7-L3

APPLICABILITÀ

Suzuki AN Burgman 400 K7/LO 400 4T 07-10, AN Burgman 400 L1 400 4T 11-11, AN Burgman L2 400 4T 12-12, AN Burgman L3 400 4T 13-13



◀ cod. **FZ00368**

Campana frizione per motore scooter 50 cc Minarelli/Yamaha ø 105 mm



◀ cod. **FZ00369**

Campana frizione per motore scooter 50 cc Minarelli/Yamaha ø 107 mm



◀ cod. **FZ00375**

Campana frizione Honda @ - SH 125/150

RIFERIMENTO ORIGINALE

Honda	22101KCW850
Kymco	00127702

Malaguti	65044600
Keeway	200093120000

APPLICABILITÀ

Honda @ [NES] 125 125 4T 00-06, Dylan 125 [SES] 125 4T 02-04, PS I 125 [PES] 125 4T 06-10, Pantheon 125 IE [FES] 125 4T-2V 03-05, SH 125 125 4T-2V 01-04, SH IE 125 Scoopy 125 4T-2V 05-12, Silver Wing 125 [FES] 125 4T-2V 07-12, @ [NES] 150 150 4T 00-06, Dylan 150 [SES] 150 4T 02-04, PS I 150 [PES] 150 4T 06-10, Pantheon 150 IE [FES] 150 4T-2V 03-05, SH 150 150 4T-2V 01-04, SH IE 150 Scoopy 150 4T 05-12, Silver Wing 150 [FES] 150 4T-2V 07-12

Keeway Outlook 125 125 4T 07-08, Outlook 150 150 4T 07-08

Kymco Agility 125 125 4T 06-06, Agility 125 EU3 125 4T 06-08, Agility 125 R16 125 4T 08-09, Agility 125 RS 125 4T 09-09, Agility Plus 125 4T 14-14, Agility R16 125 4T 12-12, Heroism 125 125 4T 95-97, K-XCT I 125 4T 12-14, Like 125 125 4T 09-09, Movie 125 125 4T 99-00, Movie 125 EU3 125 4T 06-07, Movie XL 125 125 4T 01-01, Movie XL 125 EU2 125 4T 03-04,

People 125 125 4T 99-00, People 125 EU3 125 4T 07-08, People EU3 125 4T 11-11, People ONE I 125 4T 13-13, People S 125 125 4T 05-05, People S DD EU3 125 125 4T 07-08, Super 8 125 125 4T 08-09, Vivio 125 125 4T 00-00, Agility 150 R16 150 4T 08-09, Heroism 150 150 4T 95-97, Movie 150 EU3 150 4T 06-07, Movie XL 150 150 4T 01-01, Movie XL 150 EU2 150 4T 03-04, People 150 150 4T 99-00, People 150 EU2 150 4T 03-03, Vivio 150 150 4T 00-00, Agility 200I R16 200 4T 10-10, Agility I Plus 200 4T 14-14, Agility R16 200 4T 12-12, Like 200 IE 200 4T 09-09, Like LX 200 4T 12-12, People S 200 200 4T 05-05, People S 200 I 200 4T 07-07

Malaguti

Blog 125 IE 125 4T 09-10, Centro 125 IE EU3 125 4T 08-09, Centro SL 125 IE EU3 125 4T 09-10, Ciak Master 125 125 4T 04-04, Ciak Master 150 150 4T 04-04, Blog 160 IE 160 4T 09-10, Centro 160 IE EU3 160 4T 08-09, Centro SL 160 IE EU3 160 4T 09-10, Ciak Master 200 EU2 200 4T 06-06



◀ cod. **FZ00376**

Campana frizione per motore scooter 50 cc Piaggio

RIFERIMENTO ORIGINALE

Piaggio	289933
---------	--------



◀ **cod. FZ00377**
Campana frizione per motore scooter 125/150/180 4T Piaggio

RIFERIMENTO ORIGINALE

Piaggio	8440494
Aprilia	8440494
Gilera	8440494

Derbi	8440494
Malaguti	42606500
Peugeot	756258

APPLICABILITÀ

Aprilia Atlantic 125 125 4T 03-05, Atlantic Arrecife 125 125 4T -00, Scarabeo 125 125 4T 04-06, Sportcity 125 125 4T 04-06, Atlantic 200 200 4T 03-05, Atlantic Arrecife 200 200 4T -00, Sportcity 200 200 4T 04-06, Scarabeo 250 250 4T 04-06

Derbi Boulevard 125 125 4T 02-04, Boulevard 125 EU3 125 4T 04-07, GP1 125 EU 2 125 4T 06-06, Boulevard 150 150 4T 02-04, Boulevard 150 EU3 150 4T 04-07

Gilera DNA 125 125 4T 01-01, Runner VX 125 125 4T 00-06, DNA 180 180 4T 01-01, Runner 180 180 4T 00-01, Runner VXR 180 180 4T 00-01

Malaguti Madison S Restyling 200 200 4T 02-02

Piaggio Beverly 125 125 4T 01-03, Skypper 125 4T 125 4T 00-02, Super Hexagon GTX 12 125 125 4T 01-02, Vespa ET4 125 125 4T 99-02, X9 125 125 4T 01-02, Zip 125 125 4T 00-02, Skypper 150 4T 150 4T 00-02, Vespa ET4 150 150 4T 99-02, Hexagon GTX 180 180 4T 00-00, Super Hexagon GTX 12 180 180 4T 01-02, X9 Amalfi 180 180 4T 00-03, Beverly 200 200 4T 01-03, Vespa GRANTURISMO 200 200 4T 03-05, Vespa GTS 200 EU3 200 4T -00, Vespa GTV 200 EU3 200 4T -00

Renault Fulltime 125 125 4T -00

◀ **cod. FZ00379**
Campana frizione per motore scooter 125 cc Minarelli/Yamaha

RIFERIMENTO ORIGINALE

Yamaha	4CWE66110000
Yamaha	5DSE66110000

Yamaha	5XLE66110000
--------	--------------

APPLICABILITÀ

Italjet Millenium 125 cc 4T LC (Minarelli)

Malaguti Madison 125 cc 2T LC (Minarelli)

MBK Doodo 125 cc 4T, Flame 125 cc 4T AC 95-99, Skyliner 125 cc 4T, Thunder 125 cc 4T

Yamaha Cygnus X 125 cc 4T AC, Cygnus X IE EU3 125 cc 4T AC, Majesty 125 cc 4T, Maxter 125 cc 4T, Teo's 125 cc 4T



◀ **cod. FZ00380**
Campana frizione per motore scooter 50 cc Aprilia D. Tech

RIFERIMENTO ORIGINALE

Aprilia	AP2MDA000426
---------	--------------



◀ **cod. FZ00384**
Campana frizione per Piaggio Beverly 500 cc 4T

RIFERIMENTO ORIGINALE

Piaggio	825176
---------	--------

APPLICABILITÀ

Aprilia Atlantic 500 500 4T 01-04, Scarabeo 500 500 4T 03-06

Gilera Fuoco 500 IE EU3 500 4T 07-13, Nexus 500 500 4T 03-05, Nexus 500 EU3 500 4T 06-11, Nexus SP 500 EU3 500 4T 06-07

Malaguti Spider Max 500 GT 500 4T 04-05, Spider Max 500 GT EU3 500 4T 06-06, Spider Max RS 500 500 4T 08-08

Peugeot Geopolis 400 IE EU3 400 4T-4V -00, Satelis 400 EU3 400 4T -00, Geopolis 500 IE EU3 500 4T-4V -00, Satelis 500 EU3 500 4T -00

Piaggio Beverly 400 EU3 400 4T 06-07, Beverly Tourer 400 EU3 400 4T 08-10, MP3 400 400 4T 07-08, MP3 400 IE LT Touring 400 4T 11-11, MP3 400 IE LT/Sport 400 4T 08-10, MP3 400 MIC 400 4T 08-10, MP3 400 RL Touring 400 4T 11-11, X-Evo 400 400 4T 07-11, X8 400 EU3 400 4T 06-08, Beverly 500 500 4T 02-06, Beverly 500 ie EU3 500 4T 06-08, MP3 500 LT Sport/Business 500 4T -, MP3 500 RL Sport 500 4T -, X9 500 500 4T 01-02, X9 Evolution 500 500 4T 03-07



◀ **cod. FZ00391**
Campana frizione Honda SH 300 cc

RIFERIMENTO ORIGINALE

Honda	22100KFG000
-------	-------------

APPLICABILITÀ

Honda Pantheon 125 [FES] 125 2T 98-02, Pantheon 150 [FES] 150 2T 98-02, Foresight 250 [FES] 250 4T 98-99, Forza 250 [NSS] 250 4T-2V 02-07, Jazz 250 ES Reflex [NSS] 250 4T-2V 01-04, Jazz 250 Reflex [NSS] 250 4T-2V 01-01, SH IE 300 Scoopy 300 4T-4V 07-16



◀ **cod. FZ00395**
Campana frizione Piaggio 125cc

RIFERIMENTO ORIGINALE

Piaggio	8440494
---------	---------

Piaggio	875973
---------	--------

APPLICABILITÀ

- Aprilia** Atlantic 125 EU3 125 4T 06-08, Atlantic 125 EU3 125 4T 10-12, Mojito 125 125 4T 03-08, SR Motard 125 125 4T 2V 12-12, Scarabeo 125 125 4T 03-03, Scarabeo EU3 125 125 4T 06-07, Sport City Street 125 125 4T 12-12, Sportcity 125 EU3 125 4T 06-08, Sportcity Cube 125 125 4T 08-10, Sportcity Cube 200 125 4T 08-10, Sportcity One 4T EU3 125 125 4T 08-11, Mojito 150 150 4T 03-07, Sportcity 200 EU3 200 4T 06-08, Atlantic 250 EU3 250 4T 06-08, Scarabeo Light 250 250 4T 06-08, Sportcity 250 EU3 250 4T 06-08, Sportcity Cube 250 250 4T 08-12, Atlantic 300 300 4T 10-11, Scarabeo Light 300 300 4T 09-10, Sportcity Cube 300 300 4T 08-10, Sport City Street 300 300 4T 12-12
- Derbi** Boulevard 4T EU3 125 4T 08-12, GP1 Low Seat EU3 125 4T 07-08, Rambla 125 125 4T 08-09, Boulevard 200 EU2 200 4T 05-06, GP1 250 250 4T 06-07, GP1 250 Low Seat EU3 250 4T 07-08, Rambla 250 250 4T 08-09, Rambla 250 EU3 250 4T 08-08, Rambla 300 300 4T 10-11
- Gilera** Nexus 125 EU3 125 4T 07-08, Nexus 125 IE EU3 125 4T 08-10, Runner VXR 200 200 4T 02-06, Nexus 250 EU3 250 4T 06-07, Nexus 300 EU3 300 4T 08-11

- Malaguti** Madison 3 125 125 4T 06-09, Madison R 180 180 4T 01-02, Phantom Max 200 200 4T 03-03, Madison 3 250 250 4T 06-09, Madison RS 250 250 4T 04-04, Phantom Max 250 250 4T 04-04
- Piaggio** Beverly 125 EU3 125 4T 07-08, Beverly 125 Tourer EU3 125 4T 07-10, Beverly RST 125 125 4T 04-07, Carnaby 125 125 4T 07-10, Fly 125 125 4T 05-07, Hexagon GTX 125 125 4T 00-00, Liberty 125 125 4T 98-02, MP3 125 125 4T 06-08, MP3 125 IE 125 4T 08-09, MP3 125 IE Touring 125 4T 11-12, MP3 125 Ibrido 125 4T 09-10, MP3 125 Yourban ERL 125 4T 11-11, Vespa GRANTURISMO 125 125 4T 03-07, Vespa GRANTURISMO 125 EU3 125 4T 06-07, Vespa GTS 4T IE SUPER 125 4T 09-16, Vespa LX 125 125 4T 05-06, Vespa LX 4T EU3 TOURING 125 4T 10-11, Vespa LX 4T FL 125 4T 09-09, Vespa LX EU3 125 4T 06-08, Vespa LX EU3 IE 125 4T 09-10, Vespa LXV 4T EU3 125 4T 06-09, Vespa LXV IE 4T 125 4T 10-12, Vespa LXV NAVY EU3 125 4T 07-08, Vespa S 4T 125 EU3 125 4T 07-08, Vespa S 4T IE & COLLEGE 125 4T 09-11, X-Evo 125 125 4T 07-16, X7 125 EU3 125 4T 08-08, X7 Evo 125 IE EU3 125 4T 09-10, X8 125 125 4T 04-06, Fly 150 150 4T 05-07, Liberty 150 150 4T 01-02,

- Vespa LX 150 150 4T 05-06, Vespa LX EU3 150 4T 06-08, Vespa LX EU3 IE 150 4T 09-11, X8 Street 150 EU2 150 4T 06-08, Carnaby 200 200 4T 07-08, Liberty 200 200 4T 06-06, Liberty 200 4T Sport EU3 200 4T 06-07, Vespa GRANTURISMO 200 200 4T 06-07, X8 200 200 4T 04-07, Beverly 250 250 4T 06-07, Beverly 250 Tourer EU3 250 4T 07-09, Beverly 250 ie EU3 250 4T 06-08, MP3 250 250 4T 06-08, MP3 250 LT 250 4T 08-09, MP3 250 MIC 250 4T 08-09, Vespa GT 60 250 EU3 250 4T 06-07, Vespa GTS 250 250 4T 05-16, Vespa GTS ABS 250 250 4T 05-12, Vespa GTV 250 250 4T 06-09, X-Evo 250 250 4T 07-16, X7 250 EU3 250 4T 08-08, Beverly Tourer 300 EU3 300 4T 09-10, Carnaby Cruiser 300 300 4T 09-12, MP3 300 4T 4V IE LT Ibrido 300 4T 10-11, MP3 300 IE LT 300 4T 10-11, MP3 300 IE LT Touring 300 4T 11-13, MP3 300 IE LT/Sport 300 4T 11-14, MP3 300 IE MIC 300 4T 10-11, MP3 300 IE Touring 300 4T 11-12, MP3 300 Yourban ERL 300 4T 11-15, MP3 300 Yourban LT ERL 300 4T 11-12, Vespa GTS Super 300 4T 08-15, Vespa GTV VIA MONTENAPOLIONE 300 4T 10-10, X7 Evo 300 IE EU3 300 4T 09-10



◀ **cod. FZ00397**
Campana frizione Yamaha X-Max 250 ø 145

RIFERIMENTO ORIGINALE

Yamaha	5GM166110000
--------	--------------

APPLICABILITÀ

- Aprilia** Leonardo 250 250 4T 02-04, Leonardo 300 300 4T 02-04
- Italjet** Jupiter 250 250 4T 00-00
- Malaguti** Madison S 250 250 4T 99-01, Password 250 250 4T 05-06, Password 250 EU3 250 4T 07-08

- Mbk** Skyliner 250 250 4T 00-03, Skyliner 250 ABS 250 4T 03-03, Kilibre 300 300 4T 03-06
- Yamaha** Majesty 250 250 4T 00-03, Majesty 250 ABS 250 4T 03-03, X-City 250 250 4T 07-12, X-Max 250 250 4T 05-12, Versity 300 300 4T 03-06



◀ **cod. FZ00399**
Campana frizione Kymco Xciting 300 cc

RIFERIMENTO ORIGINALE

Kymco	00127980
-------	----------

APPLICABILITÀ

- Kymco** B&W 250 250 4T 00-00, B&W 250 EU2 250 4T 03-03, Grand Dink 250 250 4T 01-02, Grand Dink 250 EU2 250 4T 03-04, People LC 250 250 4T 03-04, People S 250 250 4T 06-06, Xciting 250 I 250 4T 06-07, Yup 250 250 4T 03-03, Xciting 300 I 300 4T 08-08, Xciting R 300i 300 4T 08-09



◀ **cod. FZ00402**
Campana Frizione Suzuki Burgman 400cc K7-L3

RIFERIMENTO ORIGINALE

Suzuki	21220-05H20-000
--------	-----------------

APPLICABILITÀ

- Suzuki** AN Burgman 400 K7/L0 400 4T 07-10, AN Burgman 400 L1 400 4T 11-11, AN Burgman L2 400 4T 12-12, AN Burgman L3 400 4T 13-13, AN Burgman L4 400 4T 14-14, AN Burgman L5 400 4T 15-15, AN Burgman L6 400 4T 16-16



◀ **cod. FZ00404**
Campana Frizione Honda Vision 110cc

RIFERIMENTO ORIGINALE

Honda	22100-GFM-900
-------	---------------

APPLICABILITÀ

Honda Vision 110 [NSC] 110 4T-2V 12-12



◀ **cod. FZ00406**
Campana Frizione Honda PCX125cc

RIFERIMENTO ORIGINALE

Honda	22100-KWN-900
-------	---------------

APPLICABILITÀ

Honda PCX 125 125 4T-2V 10-13



◀ **cod. FZ00408**
Campana Frizione Kymco Downtown 200/300cc

RIFERIMENTO ORIGINALE

Kymco	122150
-------	--------

APPLICABILITÀ

Kymco Downtown I 200 200 4T 10-10, People GTI 200 200 4T 10-10, Downtown 300I 300 4T 09-09, Downtown ABS 300 300 4T 10-10, Downtown I 300 300 4T 11-11, Downtown I ABS 300 300 4T 11-11, People GTI 300 300 4T 10-11



◀ **cod. FZ00412**
Campana Frizione Suzuki Burgman 125cc K7-L3

RIFERIMENTO ORIGINALE

Suzuki	21220-20E50-000
--------	-----------------

APPLICABILITÀ

Suzuki UH Burgman 125 K7/L0 125 4T 07-10, UH Burgman 125 L1 125 4T 11-11, UH Burgman 125 L3 125 4T 13-13, UX Sixteen 125 K8/L0 125 4T 08-10, UX Sixteen 125 L1 125 4T 11-11, UX Sixteen 150 K8/L0 150 4T 08-10, UX Sixteen 150 L1 150 4T 11-11



◀ **cod. FZ00415**
Campana frizione Yamaha X-MAX 125cc

RIFERIMENTO ORIGINALE

Yamaha	1B9E66110000
--------	--------------

APPLICABILITÀ

Yamaha X-City 125 EU3 125 4T-4V 08-11, X-Max R 125 ABS 125 4T-4V 11-11, X-Max R 125 EU3 125 4T-4V 06-12



◀ **cod. FZ00416**
Campana frizione Sym Symphony 125/150cc

RIFERIMENTO ORIGINALE

Sym	22101M9Q000
-----	-------------

APPLICABILITÀ

Sym Attila 125 125 4T 99-00, Euro MX 125 125 4T 02-02, Euro MX EU2 125 125 4T 03-04, Fiddle II 125 125 4T 08-10, GTS Joymax 125 125 4T 06-07, HD EU2 125 125 4T-4V 03-04, HD EU3 125 125 4T-4V 07-08, HD EVO 125 125 4T-4V 05-06, HD EVO EU3 125 125 4T-4V 07-08, HD EVO EU3 125 125 4T-4V 10-11, HD EVO Tamburo EU3 125 125 4T-4V 08-09, HD2 125 125 4T-4V 11-11, Jet 4 125 125 4T 09-10, Jet V 125 4T 11-11, JoyRide EU2 125 125 4T-4V 05-06, JoyRide EU3 125 4T-4V 07-07, JoyRide EVO 125 4T-4V 09-10, Megalo 125 125 4T 06-07, New Duke 125 125 4T 00-01, Shark 125 125 4T 99-02, Super Duke 125 125 4T 99-02, Symphony 125 125 4T 09-09, Symphony S 125 125 4T 09-10, Symphony SR 125 125 4T 10-10, Symplly 125 125 4T 07-08, Symplly II 125 125 4T 09-10, VS 125 125 4T-4V 06-06, VS 125 EU3 125 4T-4V 07-08, Attila 150 150 4T 99-00, Euro MX 150 150 4T 02-02, Euro MX EU2 150 150 4T 03-04, Fiddle II 150 150 4T 10-10, Shark 150 150 4T 00-01, Symphony 150 150 4T 09-09, Symphony S 150 150 4T 10-10, Symphony SR 150 150 4T 10-10, VS 150 150 4T-4V 06-06, VS 150 EU3 150 4T-4V 07-08, Track Runner 180 180 4T 06-07



◀ cod. **IM07024**
Biella Vespa 50 S PK XL normale



◀ cod. **IM07031**
Biella scooter Piaggio/Gilera 50 cc



◀ cod. **IM07032**
Biella con gabbia per motore scooter 50 cc Minarelli/Yamaha



◀ cod. **IM07033**
Biella con gabbia per motore Minarelli AM AXE 16 mm



◀ cod. **IM07036**
Biella con gabbia per motore Minarelli AM6 AXE 18 mm



◀ cod. **IM07037**
Biella completa per motore Minarelli YP 250 cc

APPLICABILITÀ

Aprilia Leonardo 250 250 4T 99-04, Leonardo 250 ST 250 4T 01-01, Leonardo 300 300 4T 02-04
Benelli Velvet 250 250 4T 99-03
Italjet Jupiter 250 250 4T 00-00
Malaguti Madison S 250 250 4T 99-01, Password 250 250 4T 05-06, Password 250 EU3 250 4T 07-08

Mbk

Yamaha

Skyliner 250 250 4T 00-03, Skyliner 250 ABS 250 4T 03-03, Kilibre 300 300 4T 03-06

Majesty 250 250 4T 96-03, Majesty 250 ABS 250 4T 03-03, Majesty 250 DX 250 4T 98-99, X-City 250 250 4T 07-12, X-Max 250 250 4T 05-12, Versity 300 300 4T 03-06



◀ cod. **IM07005**
Albero motore Vespa 50 S normale (cono 19 mm)

RIFERIMENTO ORIGINALE

Piaggio	1232946
---------	---------

RICAMBIO

IM07024	BIELLA
---------	--------

◀ cod. **IM07007**
Albero motore Vespa 50 PK-XL Normale (cono 20 mm)

RIFERIMENTO ORIGINALE

Piaggio	2245875
---------	---------

RICAMBIO

IM07024	BIELLA
---------	--------



◀ cod. **IM07013**
Albero motore per scooter 50 cc Minarelli/Yamaha verticale

RIFERIMENTO ORIGINALE

Mbk	3VLE14001000
-----	--------------

Yamaha	3VLE14001000
--------	--------------

RICAMBIO

IM07032	BIELLA
---------	--------

AA00765	GABBIA
---------	--------

◀ cod. **IM07014**
Albero motore per scooter 50 cc Minarelli/Yamaha orizzontale

RIFERIMENTO ORIGINALE

Mbk	5RNE14001100
-----	--------------

Yamaha	5RNE14001100
--------	--------------

RICAMBIO

IM07032	BIELLA
---------	--------

AA00765	GABBIA
---------	--------



◀ cod. **IM07015**
Albero motore per scooter 50 cc Piaggio/Gilera

RIFERIMENTO ORIGINALE

Piaggio	4316255
---------	---------

Gilera	4316255
--------	---------

Aprilia	4316255
---------	---------

Derbi	4316255
-------	---------

RICAMBIO

IM07031	BIELLA
---------	--------

AA00777	GABBIA
---------	--------



◀ cod. **IM07016**
Albero motore per scooter 50 cc Peugeot Buxy

RIFERIMENTO ORIGINALE

Peugeot	768174
---------	--------



◀ cod. **IM07017**
Albero motore completo per motore Minarelli AM 345/6

RICAMBI

IM07036	BIELLA	AA00766	GABBIA
---------	--------	---------	--------



◀ cod. **IM07018**
Albero motore F12 Phantom H20 versione dal 2000

RIFERIMENTO ORIGINALE

Malaguti	77116200
----------	----------

APPLICABILITÀ

Malaguti F12 Phantom Euro 2 50 2T 02-02, F12 Phantom Euro 2,3 50 2T 03-04, F12 Phantom LC Euro 2 2,3 50 2T 03-04, F12 Restyling Euro 1 50 2T 99-02, F12 Restyling Euro 2 50 2T 06-06, F12 Restyling LC Euro 2 50 2T 06-06



◀ cod. **IM07040**
Albero motore Derbi Senda 50 cc

RIFERIMENTO ORIGINALE

Derbi	00H02508141
-------	-------------



◀ cod. **IM07044**
Albero motore per 50 cc Aprilia D. Tech 2T IE

RIFERIMENTO ORIGINALE

Aprilia	AP1BFA000699
---------	--------------



◀ cod. **IM07064**
Albero motore scooter Piaggio 50 cc Purejet

RIFERIMENTO ORIGINALE

Piaggio	8269405	Gilera	8269405
Aprilia	8269405		



◀ **cod. IM07065**
Albero motore scooter 50 cc Keeway/CPI

RIFERIMENTO ORIGINALE

Keeway	208100022000
--------	--------------

Malaguti	59012200
----------	----------

APPLICABILITÀ

Benelli Pepe 50 2T 10-10, Pepe LX 50 2T 07-09, Pepe Old 50 2T 07-09, Pepe Old 50 2T 11-11, Quattronex 50 2T 08-11

CPI Aragon 50 2T 03-03, Hussar 50 2T 03-03, Oliver 50 2T 03-03, Pop Corn 50 2T 03-03

Explorer Cracker 50 2T 03-03

Keeway ATV 50 EC2 50 2T 06-06, ATV OFF ROAD 50 2T 07-07, F-Act 50 2T 07-08, Flash 50 2T 07-08, Focus 50 2T 06-06, Goccia 50 2T 09-09, Hurricane 50 2T 06-08, Matrix 50 2T 06-08, Pixel Euro 2.50 2T -00, RY8 50 2T 08-08

Malaguti F10 Wap Euro 2.50 2T -00, F12 R Phantom 50 2T 07-07



◀ **cod. IM07066**
Albero motore Derbi per Piaggio D50B0, D50B1

RIFERIMENTO ORIGINALE

Derbi	874224
-------	--------

Aprilia	874224
---------	--------



◀ **cod. IM07058**
Albero motore completo di cuscinetti e paraoli per motori scooter 50 cc Minarelli/Yamaha tipo verticale



◀ **cod. IM07059**
Albero motore completo di cuscinetti e paraoli per motori scooter 50 cc Minarelli/Yamaha tipo orizzontale



◀ cod. **IM07060**
Albero motore completo di cuscinetti e paraoli per Piaggio/Gilera



◀ cod. **IM07061**
Albero motore completo di cuscinetti e paraoli per motori scooter 50 cc Peugeot



◀ cod. **IM07062**
Albero motore completo di cuscinetti e paraoli per AM345/ AM6



◀ cod. **IM07063**
Albero motore completo di cuscinetti e paraoli per Derbi Senda 50 cc



◀ cod. **IM07045**
Albero motore per motori Minarelli YP 125

RIFERIMENTO ORIGINALE

Yamaha	5XLE14001100
Mbk	5XLE14001100

Malaguti	77118600
Benelli	R12040201A0

APPLICABILITÀ

Benelli Velvet 125 125 4T 99-01

Italjet Jupiter 125 125 4T -00, Millenium 125 125 4T -00

Malaguti Madison 125 125 4T 99-01, Madison R Restyling 125 125 4T 02-02, Madison R Restyling 125 EU2 125 4T 03-04, Phantom Max 125 125 4T 03-03

Mbk

Doodo 125 125 4T 00-00, Skyliner 125 125 4T 98-02, Skyliner E 125 125 4T 03-03, Thunder 125 125 4T 01-02

Yamaha

Majesty 125 125 4T 98-02, Majesty 125 E 125 4T 03-09, Maxter 125 125 4T 01-02, Teo's 125 125 4T 00-00



◀ cod. **IM07050**
Albero motore per scooter Suzuki Burgman 250 cc 4T

RIFERIMENTO ORIGINALE

Suzuki	12200-14F00-000
--------	-----------------

APPLICABILITÀ

Suzuki AN Burgman 250 K3/K6 250 4T 03-06



◀ cod. **IM07051**
Albero motore per scooter Suzuki Burgman 400 cc 4T (99 - 06)

RIFERIMENTO ORIGINALE

Suzuki	12200-15F00-000
--------	-----------------

APPLICABILITÀ

Suzuki AN Burgman 400 K3/K6 400 4T 03-06, AN Burgman 400 X/K2 400 4T 99-02



◀ cod. **IM07052**
Albero motore per scooter Suzuki Burgman 150 cc 4T

RIFERIMENTO ORIGINALE

Suzuki	12200-49F50-000
--------	-----------------

APPLICABILITÀ

Suzuki UH Burgman 150 K2/K6 150 4T 02-06



◀ **cod. IM07054**
Albero motore per motori Minarelli YP 250

RIFERIMENTO ORIGINALE

Aprilia	AP8122470
---------	-----------

APPLICABILITÀ

Aprilia	Leonardo 250 250 4T 99-04, Leonardo 250 ST 250 4T 01-01	Mbk	Skyliner 250 250 4T 00-03, Skyliner 250 ABS 250 4T 03-03
Benelli	Velvet 250 250 4T 99-03	Yamaha	Majesty 250 250 4T 96-03, Majesty 250 ABS 250 4T 03-03, Majesty 250 DX 250 4T 98-99, X-City 250 250 4T 07-12, X-Max 250 250 4T 05-12
Italjet	Jupiter 250 250 4T 00-00		
Malaguti	Madison S 250 250 4T 99-01, Password 250 250 4T 05-06, Password 250 EU3 250 4T 07-08		

RICAMBI

IM07037	BIELLA
---------	--------



◀ **cod. IM07055**
Albero motore Honda SH 125 cc 4T

RIFERIMENTO ORIGINALE

Honda	13000KGF910
-------	-------------

APPLICABILITÀ

Honda @ [NES] 125 125 4T 00-06, Dylan 125 [SES] 125 4T 02-04, PS I 125 [PES] 125 4T 06-10, Pantheon 125 IE [FES] 125 4T-2V 03-05, SH 125 125 4T-2V 01-04, SH IE 125 Scoopy 125 4T-2V 05-12, Silver Wing 125 [FES] 125 4T-2V 07-12



◀ **cod. IM07056**
Albero motore Honda SH 150 cc 4T

RIFERIMENTO ORIGINALE

Honda	13000KGG910
-------	-------------

APPLICABILITÀ

Honda @ [NES] 150 150 4T 00-06, Dylan 150 [SES] 150 4T 02-04, PS I 150 [PES] 150 4T 06-10, Pantheon 150 IE [FES] 150 4T-2V 03-05, SH 150 150 4T-2V 01-04, SH IE 150 Scoopy 150 4T 05-12, Silver Wing 150 [FES] 150 4T-2V 07-12



◀ **cod. IM07057**
Albero motore Kymco 250 cc

RIFERIMENTO ORIGINALE

Kymco	00123900
-------	----------

APPLICABILITÀ

Kymco B&W 250 250 4T 00-00, B&W 250 EU2 250 4T 03-03, Grand Dink 250 250 4T 01-02, Grand Dink 250 EU2 250 4T 03-04, People LC 250 250 4T 03-04, People S 250 250 4T 06-06, People S 250 I 250 4T 07-07, Xciting 250 250 4T 05-05, Xciting 250 I 250 4T 06-07, Yup 250 250 4T 03-03



◀ **cod. IM07067**
Albero motore Piaggio Vespa 125 ET3

APPLICABILITÀ

Piaggio Vespa 125 ET3 125 2T 76-83, Vespa 125 Primavera 125 2T 67-83



◀ **cod. IM07068**
Albero motore Piaggio Vespa 125 PX

APPLICABILITÀ

Piaggio Vespa PX 125 125 2T 98-01, Vespa PX 125 125 2T 11-16, Vespa PX 125 EU2 125 2T 01-07, Vespa PX 30 Anni 125 2T 07-08, Vespa PX E 125 Arcobaleno 125 2T 81-97, Vespa PX 150 150 2T 98-01, Vespa PX 150 150 2T 11-16, Vespa PX E 150 Arcobaleno 150 2T 81-97



◀ **cod. IM07069**
Albero Motore Sym Symphony 125cc

APPLICABILITÀ

Sym Fiddle II 125 125 4T 10-10, Jet 4 125 125 4T 09-10, Symphony 125 125 4T 09-09, Symphony S 125 125 4T 09-10, Symphony SR 125 125 4T 10-10

RIFERIMENTO ORIGINALE

Sym	13000ARA000
-----	-------------



◀ cod. **IM07071**
Albero Motore Kymco Agility 125cc

APPLICABILITÀ

Kymco Agility 125 125 4T 06-06, Agility 125 EU3 125 4T 06-08, Agility 125 R16 125 4T 08-09, Agility 125 RS 125 4T 09-09, Like 125 125 4T 09-09, Movie 125 125 4T 99-00, Movie 125 EU3 125 4T 06-07, Movie XL 125 125 4T 01-01, Movie XL 125 EU3 125 4T 03-04, People 125 125 4T 99-00, People 125 EU2 125 4T 03-03, People 125 EU3 125 4T 07-08, People EU3 125 4T 11-11, People S 125 125 4T 05-05, People S DD EU3 125 125 4T 07-08, Super 8 125 125 4T 08-09, Vivio 125 125 4T 00-00, Agility 150 R16 150 4T 08-09, Movie XL 150 150 4T 01-01, Movie XL 150 EU2 150 4T 03-04, People 150 150 4T 99-00, People 150 EU2 150 4T 03-03, Vivio 150 150 4T 00-00

RIFERIMENTO ORIGINALE

Kymco	123127
-------	--------

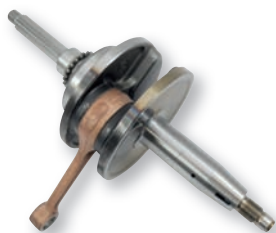

◀ cod. **IM07072**
Albero Motore Yamaha X-Max 125cc

APPLICABILITÀ

Mbk Cityliner 125 EU3 125 4T-4V 08-10, Skycruiser 125 125 4T-4V 07-07

Yamaha X-City 125 EU3 125 4T-4V 08-11, X-Max R 125 125 4T-4V 06-16, X-Max R 125 ABS 125 4T-4V 11-11, X-Max RA 125 ABS 125 4T-4V 13-16

RIFERIMENTO ORIGINALE

Yamaha	39DE14003000
--------	--------------



◀ cod. **IM070701**
Albero Motore Piaggio Liberty 125cc (sel.1)

APPLICABILITÀ

Aprilia Atlantic 125 EU3 125 4T 06-08, Atlantic 125 EU3 125 4T 10-12, Mojito 125 125 4T 03-08, Scarabeo EU3 125 125 4T 06-07, Sportcity 125 EU3 125 4T 06-08, Sportcity Cube 125 125 4T 08-10, Sportcity One 4T EU3 125 125 4T 08-11

Derbi Boulevard 125 EU3 125 4T 04-07, Boulevard 4T EU3 125 4T 08-12, GP1 125 EU 2 125 4T 06-06, GP1 Low Seat EU3 125 4T 07-08, Rambla 125 125 4T 08-09, Rambla 125 EU3 2VER 125 4T 08-08, Sonar 4T 125 125 4T 09-11, Variant Sport 4T EU3 125 4T 12-12, Boulevard 150 EU3 150 4T 04-07, Boulevard 4T E3 150 4T 10-10, Sonar 4T 150 150 4T 09-09

Gilera Nexus 125 EU3 125 4T 07-08, Runner VX 125 125 4T 02-06, Runner VX 4T EU3 125 125 4T 06-07, Runner VX Race 125 125 4T 06-06, Runner VX SC 125 4T 06-07

Piaggio Beverly 125 125 4T 01-03, Beverly 125 EU3 125 4T 07-08, Beverly 125 Tourer EU3 125 4T -, Beverly RST 125 125 4T -, Carnaby 125 125 4T 07-10, Fly 125 125 4T 05-07, Fly 125 EU3 125 4T 07-11, Hexagon GTX 125 125 4T 00-00, Liberty 125 125 4T 01-02, Liberty 125 4T 125 4T 06-07, Liberty 125 4T EU3 125 4T 07-08, Liberty 125 4T EU3 Delivery - TNT 125 4T -, Liberty 125 4T Sport EU3 125 4T 06-08, Liberty 125 Sport 125 4T 06-06, Liberty RST PTT 125 125 4T 05-11, MP3 125 125 4T 06-08,

Skypper 125 4T 125 4T 00-02, Typhoon 125 4T 2V E3 125 4T 10-11, Vespa ET4 125 125 4T 99-02, Vespa GRANTURISMO 125 125 4T 03-07, Vespa GRANTURISMO 125 EU3 125 4T 06-07, Vespa GTS 125 EU3 125 4T 07-12, Vespa GTV 125 125 4T -, Vespa GTV 4T NAVY EU3 125 125 4T 08-08, Vespa LX 125 125 4T 05-06, Vespa LX 4T EU3 TOURING 125 4T 10-11, Vespa LX 4T FL 125 4T 09-09, Vespa LX EU3 125 4T 06-08, Vespa LX EU3 IE 125 4T 09-10, Vespa LXV 4T EU3 125 4T 06-09, Vespa LXV IE 4T 125 4T 10-12, Vespa LXV NAVY EU3 125 4T -, Vespa S 4T 125 EU3 125 4T 07-08, Vespa S 4T IE & COLLEGE 125 4T 09-11, X-Evo 125 125 4T 07-12, X7 125 EU3 125 4T 08-08, X8 125 125 4T 04-06, X8 125 Premium EU2 125 4T 06-06, X8 125 Premium EU3 125 4T 06-07, X8 Street 125 EU2 125 4T 06-07, X9 125 125 4T 01-02, X9 Evolution 125 125 4T 03-03, X9 Evolution 125 125 4T 05-06, X9 Evolution EU3 125 125 4T 07-07, Zip 125 125 4T 00-02, Fly 150 150 4T 05-07, Fly 150 EU3 150 4T 08-11, Liberty 150 150 4T 01-02, Liberty 150 4T EU3 150 4T 08-08, Liberty 150 4T Sport EU3 150 4T 08-08, Liberty 150 Moc 4T 150 4T 09-13, Vespa LX 150 150 4T 05-06, Vespa LX 4T FL 150 4T 09-09, Vespa LX EU3 150 4T 06-08, Vespa LX EU3 IE 150 4T 09-11, Vespa LX TOURING 150 4T -, Vespa S 4T 150 150 4T 08-09, Vespa S 4T IE & COLLEGE 150 4T 09-11, X8 Street 150 EU2 150 4T 06-08



◀ cod. **IM070702**
Albero Motore Piaggio Liberty 125cc (sel.2)

APPLICABILITÀ

Aprilia Atlantic 125 EU3 125 4T 06-08, Atlantic 125 EU3 125 4T 10-12, Mojito 125 125 4T 03-08, Scarabeo EU3 125 125 4T 06-07, Sportcity 125 EU3 125 4T 06-08, Sportcity Cube 125 125 4T 08-10, Sportcity One 4T EU3 125 125 4T 08-11

Derbi Boulevard 125 EU3 125 4T 04-07, Boulevard 4T EU3 125 4T 08-12, GP1 125 EU 2 125 4T 06-06, GP1 Low Seat EU3 125 4T 07-08, Rambla 125 125 4T 08-09, Rambla 125 EU3 2VER 125 4T 08-08, Sonar 4T 125 125 4T 09-11, Boulevard 150 EU3 150 4T 04-07, Boulevard 4T E3 150 4T 10-10, Sonar 4T 150 150 4T 09-09

Gilera Nexus 125 EU3 125 4T 07-08, Runner VX 125 125 4T 02-06, Runner VX 4T EU3 125 125 4T 06-07, Runner VX Race 125 125 4T 06-06, Runner VX SC 125 4T 06-07

Piaggio Beverly 125 125 4T 01-03, Beverly 125 EU3 125 4T 07-08, Beverly 125 Tourer EU3 125 4T -, Beverly RST 125 125 4T -, Carnaby 125 125 4T 07-10, Fly 125 125 4T 05-07, Fly 125 EU3 125 4T 07-11, Hexagon GTX 125 125 4T 00-00, Liberty 125 125 4T 01-02, Liberty 125 4T 125 4T 06-07, Liberty 125 4T EU3 125 4T 07-08, Liberty 125 4T EU3 Delivery - TNT 125 4T -, Liberty 125 4T Sport EU3 125 4T 06-08, Liberty 125 Sport 125 4T 06-06,

Liberty RST PTT 125 125 4T 05-11, MP3 125 125 4T 06-08, Skypper 125 4T 125 4T 00-02, Typhoon 125 4T 2V E3 125 4T 10-11, Vespa ET4 125 125 4T 99-02, Vespa GRANTURISMO 125 125 4T 03-07, Vespa GRANTURISMO 125 EU3 125 4T 06-07, Vespa GTS 125 EU3 125 4T 07-12, Vespa GTV 125 125 4T -, Vespa GTV 4T NAVY EU3 125 125 4T 08-08, Vespa LX 125 125 4T 05-06, Vespa LX 4T EU3 TOURING 125 4T 10-11, Vespa LX 4T FL 125 4T 09-09, Vespa LX EU3 125 4T 06-08, Vespa LX EU3 IE 125 4T 09-10, Vespa LXV 4T EU3 125 4T 06-09, Vespa LXV IE 4T 125 4T 10-12, Vespa LXV NAVY EU3 125 4T -, Vespa S 4T 125 EU3 125 4T 07-08, Vespa S 4T IE & COLLEGE 125 4T 09-11, X-Evo 125 125 4T 07-12, X7 125 EU3 125 4T 08-08, X8 125 125 4T 04-06, X8 125 Premium EU2 125 4T 06-06, X8 125 Premium EU3 125 4T 06-07, X8 Street 125 EU2 125 4T 06-07, X9 125 125 4T 01-02, X9 Evolution 125 125 4T 03-03, X9 Evolution 125 125 4T 05-06, X9 Evolution EU3 125 125 4T 07-07, Zip 125 125 4T 00-02, Fly 150 150 4T 05-07, Fly 150 EU3 150 4T 08-11, Liberty 150 150 4T 01-02, Liberty 150 4T EU3 150 4T 08-08, Liberty 150 4T Sport EU3 150 4T 08-08, Liberty 150 Moc 4T 150 4T 09-13, Vespa LX 150 150 4T 05-06, Vespa LX 4T FL 150 4T 09-09, Vespa LX EU3 150 4T 06-08, Vespa LX EU3 IE 150 4T 09-11, Vespa LX TOURING 150 4T -, Vespa S 4T 150 150 4T 08-09, Vespa S 4T IE & COLLEGE 150 4T 09-11, X8 Street 150 EU2 150 4T 06-08

SERIE PARAOLI



- ◀ cod. **K060040**
Serie paraoli Vespa 50-125 Primavera-125 ET3
- ◀ cod. **K06004A**
Serie paraoli originali Vespa 50-125 Primavera125 ET3
- ◀ cod. **K060050**
Serie paraoli Piaggio Vespa 125PX-150 PX-T5
- ◀ cod. **K060070**
Serie paraoli Vespa 125 PX Arcobaleno
- ◀ cod. **K060100**
Serie paraoli banco Vespa 50 PK-XL Ape 50
- ◀ cod. **K070050**
Serie paraoli scooter 50 cc Minarelli/Yamaha (6 pezzi)
- ◀ cod. **K070060**
Serie paraoli (AM 345/6)
- ◀ cod. **K070070**
Serie paraoli banco scooter 50 cc Minarelli/Yamaha
- ◀ cod. **K070080**
Serie paraoli banco scooter 50 cc Piaggio/Gilera
- ◀ cod. **K070090**
Serie paraoli banco AM 345/6
- ◀ cod. **K070100**
Serie paraoli banco scooter Piaggio Skipper 125/150 cc 2T
- ◀ cod. **K070110**
Serie paraoli banco Piaggio Beverly 125/200 4T
- ◀ cod. **K070120**
Serie paraoli banco Aprilia Scarabeo 125/150
- ◀ cod. **K070130**
Serie paraoli banco Honda Forsight 250 cc

PARAOLI



- ◀ cod. **H102670**
Aprilia: 125/150 cc (motori Rotax)
misure: 10x26x7
- ◀ cod. **H202840**
Mbk: Booster 100 cc, Skyliner 125 cc -
Yamaha: Majesty 125cc
misure: 20x28x4
- ◀ cod. **H203050**
Kymco: People 125/150 cc
misure: 19,8x30x5 in viton
- ◀ cod. **H203260**
Kymco: People 125/150 cc
misure: 20x32x6
- ◀ cod. **H223270**
Mbk: Skyliner 125cc - **Yamaha:** Majesty 125cc
misure: 22x32x7
- ◀ cod. **H254080**
Kymco: People 125/150 cc
misure: 25x40x8
- ◀ cod. **H255270**
Aprilia: 125/150 cc (motori Rotax)
misure: 25x52x7 in viton
- ◀ cod. **H274170**
Honda: 125/150 cc
misure: 27,4x41x7
- ◀ cod. **H274270**
Kymco: People 125/150 cc
misure: 27x42x7
- ◀ cod. **H284080**
Honda: 250 cc
misure: 27,9x40x8
- ◀ cod. **H294370**
Honda: 125/150 cc
misure: 29,4x43x7
- ◀ cod. **H305270**
Aprilia: 125/150 cc (motori Rotax)
misure: 30x52x7
- ◀ cod. **H345260**
Suzuki: Burgman 250/400 cc, Epicuro 125/150 cc
misure: 34x52x5,8 in viton
- ◀ cod. **H372560**
Suzuki: Burgman 400 cc
misure: 37x25x6
- ◀ cod. **H385270**
Suzuki: Burgman 250/400 cc
misure: 38x52x7

KIT CUSCINETTI E PARAOLI DI BANCO



◀ cod. **KK01000**
Kit cuscinetti (Kojo) paraoli di banco scooter Minarelli/Yamaha 50 cc

◀ cod. **KK01001**
Kit cuscinetti paraoli di banco AM 345/6

◀ cod. **KK01002**
Kit cuscinetti SKF e paraoli di banco scooter Minarelli/Yamaha 50 cc

◀ cod. **KK01003**
Kit cuscinetti paraoli di banco scooter Piaggio 50 cc

◀ cod. **KK01005**
Kit cuscinetti paraoli di banco Peugeot Speedfight 50 cc

◀ cod. **KK01008**
Kit cuscinetti paraoli di banco Derbi plurimarcia 50 cc

◀ cod. **KK01009**
Kit cuscinetti SKF (speciali) e paraoli di banco scooter Piaggio 50 cc



◀ cod. **KK01011**
Kit cuscinetti SKF e paraoli di banco Vespa 50/90 cc
1 paraolio BASF 22,7x47,05x7,5 - 1 paraolio BAB 19x32x7 - 1 cuscinetto 20x47x14 (6204) - 1 cuscinetto 17x47x14 (6303)

◀ cod. **KK01012**
Kit cuscinetti SKF e paraoli di banco Vespa PK XL 50 cc Ape 50 cc
1 paraolio BA 20x32x70 - 1 paraolio BASF 22,7x47,05x7,5 - 1 cuscinetto 20x47x14 (6204) - 1 cuscinetto 17x47x14 (6303)



◀ cod. **KK01013**
Kit cuscinetti paraoli di banco Kymco 50 cc 2T

KIT CUSCINETTI E PARAOLI DI BANCO



◀ **cod. KK01006**
Kit cuscinetti paraoli di banco Suzuki Burgman 250/400 cc

APPLICABILITÀ

Suzuki Epicuro 125 125 4T 99-01, UH Burgman 125 K2/K6 125 4T 02-06, UH Burgman 125 K7/L0 125 4T 07-10, UX Sixteen 125 K8/L0 125 4T 08-10, Epicuro 150 150 4T 99-01, UH Burgman 150 K2/K6 150 4T 02-06, UX Sixteen 150 K8/L0 150 4T 08-10, UH Burgman 200 K7/L0 200 4T 07-10, AN Burgman 250 K3/K6 250 4T 03-06, AN Burgman 400 K3/K6 400 4T 03-06, AN Burgman 400 K7/L0 400 4T 07-10, AN Burgman 400 X/K2 400 4T 99-02

◀ **cod. KK01007**
Kit cuscinetti paraoli di banco Yamaha Majesty 250/300 cc

APPLICABILITÀ

Aprilia	Leonardo 250 250 4T 99-04, Leonardo 250 ST 250 4T 01-01, Leonardo 300 300 4T 02-04	Mbk	Skyliner 250 250 4T 00-03, Skyliner 250 ABS 250 4T 03-03, Kilibre 300 300 4T 03-06
Benelli	Velvet 250 250 4T 99-03	Yamaha	Majesty 250 250 4T 96-03, Majesty 250 ABS 250 4T 03-03, Majesty 250 DX 250 4T 98-99, X-City 250 250 4T 07-12, X-Max 250 250 4T 05-12, Versity 300 300 4T 03-06
Italjet	Jupiter 250 250 4T 00-00		
Malaguti	Madison S 250 250 4T 99-01, Password 250 250 4T 05-06, Password 250 EU3 250 4T 07-08		



◀ **cod. KK01010**
Kit cuscinetti paraoli di banco Minarelli/Yamaha 125/150/180 cc

APPLICABILITÀ

Benelli	Velvet 125 125 4T 99-01, Velvet 150 150 4T 99-01	Mbk	Doodo 125 125 4T 00-00, Skyliner 125 125 4T 98-02, Skyliner E 125 125 4T 03-03, Thunder 125 125 4T 01-02, Doodo 150 150 4T 01-02, Skyliner 150 150 4T 00-02, Thunder 150 150 4T 01-02, Skyliner E 180 180 4T 03-03
Italjet	Jupiter 125 125 4T -00, Millenium 125 125 4T -00, Jupiter 150 150 4T -00, Millenium 150 150 4T -00	Yamaha	Majesty 125 125 4T 98-02, Majesty 125 E 125 4T 03-09, Maxter 125 125 4T 01-02, Teo's 125 125 4T 00-00, Majesty 150 150 4T 00-02, Maxter 150 150 4T 01-02, Teo's 150 150 4T 01-02, Majesty 180 E 180 4T 03-06
Malaguti	Madison 125 125 4T 99-01, Madison R Restyling 125 125 4T 02-02, Madison R Restyling 125 EU2 125 4T 03-04, Phantom Max 125 125 4T 03-03, Madison T 150 150 4T 99-01		



- ◀ cod. **KF00050**
Alberi cambio **Vespa**
sigla: 6200
misure: 10x30x9
- ◀ cod. **KF00100**
Mozi ciclomotore
sigla: 6201
misure: 12x32x10
- ◀ cod. **KF00150**
Tamburo **PX**
sigla: 6201/ZZ
misure: 12x32x10
- ◀ cod. **KF00200**
sigla: 6004
misure: 20x42x12
- ◀ cod. **KF00250**
Piaggio 102258
sigla: 6202
misure: 15x35x11
- ◀ cod. **KF00350**
Schermato
sigla: 6202/ZZ
misure: 15x35x11
- ◀ cod. **KF00450**
Piaggio banco frizione -
banco **Minarelli P4 - RV - GL - DL**
sigla: 6203
misure: 17x40x12
- ◀ cod. **KF00550**
Piaggio banco volano
sigla: 6204
misure: 20x47x14
- ◀ cod. **KF00600**
sigla: 6204/C3
misure: 20x47x14
- ◀ cod. **KF01000**
Lato trazione **Vespa** 50/90/125 cc
sigla: 6303
misure: 17x47x14
- ◀ cod. **KF01050**
sigla: 6303/C3
misure: 17x47x14
- ◀ cod. **KF01150**
Lato trazione **Lambretta**
sigla: 6305
misure: 25x62x17
- ◀ cod. **KF01450**
Campana frizione **Vespa** 50 cc/ET3
sigla: 16005
misure: 25x47x8
- ◀ cod. **KF01460**
Pompa acqua scooter **Minarelli/Yamaha** 50 cc
sigla: 608-2RS1-C3
misure: 8x22x7
- ◀ cod. **KF01480**
Cuscinetto di banco **Minarelli/Yamaha** 125/150 cc 4T
sigla: 6305YA1-9C3
misure: 25x62x17
- ◀ cod. **KF05000**
Banco tutti i modelli scooter **Minarelli/Yamaha** 50 cc
sigla: 6204TN9/C3
misure: 20x47x14
- ◀ cod. **KF05010**
Banco **P4 - RV - GL - DL**
sigla: 6203TN9/C3
misure: 17x40x12
- ◀ cod. **KF05020**
Albero frizione scooter **F10**
sigla: 6003TN9/C3
misure: 17x35x10
- ◀ cod. **KF05030**
Lato trazione **Vespa** 50/90/125 cc
sigla: 6303TN9/C3
misure: 17x47x14
- ◀ cod. **KF05040**
sigla: 6202TN9/C3
misure: 15x35x11
- ◀ cod. **KF05050**
Albero motore **Sfera**
sigla: BB1B447205A
misure: 20x52x12
- ◀ cod. **KF01500**
Suzuki Burgman 250/400 cc
sigla: 6207
misure: 35x72x17



cod. **MA00001**

Motorino avviamento Minarelli

RIFERIMENTO ORIGINALE

Aprilia	AP8224103
Benelli	R19240011A0
Malaguti	2404400
Yamana	45BH18001000

Yamana	4CUH18001000
MBK	45BH18001000
MBK	4CUH18001000

APPLICABILITÀ

Aprilia Amico 50 2T 94-94, Amico 50 2T 96-98, Amico GL/GLE 50 2T 93-95, Amico LX/Sport/Cat 50 2T 92-93, Area 51 50 2T 98-00, Gulliver 50 2T 95-98, Gulliver LC 50 2T 96-98, Rally 50 2T 95-03, Rally Liquid Cooled 50 2T 96-99, SR (Orizzontale) 50 2T 94-96, SR (Verticale) 50 2T 93-93, SR Liquid Cooled 50 2T 94-96, SR Recing 50 2T 97-99, SR Stealth 50 2T 97-99, SR WWW 50 2T 97-01, Scarabeo 50 2T 93-05, Sonic 50 2T 98-07, Sonic GP 50 2T 98-08

Atala Carosello 50 2T -00

Benelli 491 GT 50 2T 98-99, 491 RR 50 2T 99-01, 491 Racing 50 2T 98-99, 491 SP 50 2T 99-99, 491 ST 50 2T 99-01, 491 Sport 50 2T 98-99, K2 50 2T 98-01, K2 Liquid Cooled 50 2T 98-01, Naked 50 2T 02-02, Pepe 50 2T 99-01, Pepe LX 50 2T 03-04

Beta Ark 50 2T 96-08, Ark LC 50 2T 96-08, Chrono 50 2T 96-00, Eikon 50 2T 99-03, Quadra 50 2T 95-00, Tempo 50 2T 95-00

Italjet Dragster 50 2T -00

KTM K50 50 2T -00

Macal Sting 50 2T -00, Thunder 50 2T -00

Malaguti Centro 50 2T -00, Ciak 50 2T -00, Ciak Euro 2 2,3 50 2T 03-03, Ciak Euro 2 50 2T 01-03, Ciak Master Euro 2 50 2T 06-06, F10 50 2T -00, F10 Euro 2 50 2T -00, F10 Euro 2 2,3 50 2T 03-04, F10 Restyling Euro 2 50 2T 06-06, F12 Phantom 50 2T -00, F12 Phantom Euro 2 50 2T 02-02, F12 Phantom Euro 2 2,3 50 2T 03-04, F12 Phantom LC 50 2T -00,

F12 Phantom LC Euro 2 2,3 50 2T 03-04, F12 R Phantom LC 50 2T 07-09, F12 Restyling Euro 1 50 2T 99-02, F12 Restyling Euro 2 50 2T 06-06, F12 Restyling LC Euro 2 50 2T 06-06, F15 Firefox 50 2T -00, F15 Firefox Euro 2 50 2T 02-06, F15 Firefox Euro 2 2,3 50 2T 03-04, Yesterday 50 2T 97-00

Mbk

Booster 50 2T -00, Booster Euro 2 50 2T 04-04, Booster NG 50 2T 03-00, Booster Rocket 50 2T 97-98, Booster Spirit 50 2T 03-00, Booster Track 50 2T 96-98, Evolis 50 2T 92-95, Fizz 50 2T 94-95, Flipper 50 2T -00, Flipper Euro 2 50 2T 03-03, Forte 50 2T 94-96, Mach G 50 2T 02-04, Mach G LC 50 2T 02-04, Nitro 50 2T -00, Nitro Euro 2 50 2T 03-03, Ovetto 50 2T -00, Ovetto Euro 2 50 2T 02-02, Stunt 50 2T 00-02

Motron

Sting 50 2T -00, Syncro 50 2T -00, Thunder 50 2T -00

Rieju

First 50 2T -00, Windy 50 2T -00

Yamaha

Aerox 50 2T -00, Aerox Euro 2 50 2T 03-03, Axis 50 2T 95-96, BWS 50 2T -00, BWS Bump 50 2T 97-98, BWS Euro 2 50 2T 03-03, BWS NG 50 2T -00, BWS NG Euro 2 50 2T 03-03, Breeze 50 2T 94-95, Jog R 50 2T 02-10, Jog R LC 50 2T -00, Neo's 50 2T -00, Neo's Euro 2 50 2T 02-02, Slider 50 2T 00-02, Spy 50 2T 95-98, Why 50 2T -00, Why Euro 2 50 2T 03-03, Zest 50 2T -00, Zuma 50 2T 97-01

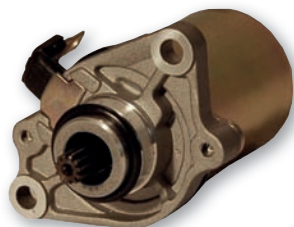

cod. **MA00002**

Motorino avviamento Piaggio

RIFERIMENTO ORIGINALE

Piaggio	82530R
---------	--------

APPLICABILITÀ

Aprilia Mojito 50 2T -, SR R FACTORY Carburatore 50 2T -, SR Street Carburatore 50 2T 03-12, Scarabeo 2T EU2 Motore Piaggio 50 2T 10-12, Scarabeo 2T Net 50 2T 09-10, Scarabeo Street 50 2T 05-06, Scarabeo Street 2T Restyling 50 2T 06-09, Sport City One 2T 50 2T 08-11

Derbi Atlantis 2T 50 2T 10-10, Atlantis 2T EU2 50 2T 07-09, Atlantis O2 50 2T 02-02, Atlantis O2 Bullet 50 2T 03-05, Atlantis O2 City 50 2T 03-06, Atlantis O2 Red Bullet 50 2T 03-03, Atlantis O2 Two Chic 50 2T 05-05, Boulevard 50 2T 09-12, GP1 50 2T 01-03, GP1 EU2 50 2T 05-05, GP1 Open EU2 50 2T 06-09, GP1 Race EU2 50 2T 05-07, Sonar 2T 50 2T 09-09

Gilera DNA 50 2T 00-02, DNA 50 2T 05-07, DNA GP Experience 50 2T 03-04, Easy Moving 50 2T 95-96, Ice 50 2T 01-05, Runner 50 2T 97-00, Runner Poggiali 50 2T 02-02, Runner SP 50 2T 02-07, Runner SP 50 2T 10-12, Runner SP ST & Simoncelli 50 2T 08-09, Runner SP Special Edition 50 2T 07-07, Stalker 50 2T 97-11, Stalker Naked 50 2T 08-08, Stalker Special Edition 50 2T 07-08, Storm 50 2T 94-95, Storm Euro 2 50 2T 07-07, Typhoon 50 2T 94-97, Typhoon X 50 2T 98-99, Typhoon XR 50 2T 00-00

Piaggio

Diesis 50 2T 01-01, Fly 2T 50 2T 05-07, Fly 2T 50 2T 10-11, Free 50 2T 92-94, Free Delivery 50 2T 00-01, Free FL 50 2T 95-02, Liberty 50 2T 97-05, Liberty 2T 50 2T 06-08, Liberty 2T PTT EU2 50 2T 04-05, Liberty 2T RST 50 2T 04-04, Liberty 2T Sport 50 2T 06-08, NRG 50 2T 94-96, NRG Extreme 50 2T 99-00, NRG MC3 50 2T 01-04, NRG Power DD 50 2T 05-13, NRG Power DD Serie Speciale 50 2T -, NRG Power DT 50 2T 06-11, NRG Power DT Serie Speciale 50 2T 07-08, NRG RST MC2 50 2T 96-98, NTT 50 2T 95-96, Quartz 50 2T 92-96, Sfera 50 2T 91-93, Sfera Maquillage 2 50 2T 94-94, Sfera RST 50 2T 95-97, Typhoon 50 2T 01-11, Typhoon 2T E2 50 2T 10-12, Typhoon 2T E3 CH 50 2T 11-11, Vespa ET2 50 2T 97-05, Vespa ET2 iniezione 50 2T 97-00, Vespa LX 2T 50 2T 05-08, Vespa LX 2T Touring 50 2T 10-11, Vespa LXV 2T 50 2T -, Vespa LXV 2T NAVY 50 2T 08-08, Vespa S 2T & College 50 2T 07-12, Zip 50 2T 92-93, Zip 50 2T 95-96, Zip 2T 50 2T -, Zip Bimodale 50 2T 94-97, Zip Fast Rider 50 2T 93-94, Zip Fast Rider RST 50 2T 96-97, Zip LC 50 2T 00-04, Zip Sp 50 2T 96-04, Zip Sp Euro 2 50 2T

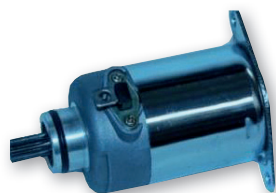

cod. **MA00004**

Motorino avviamento Peugeot/Sym125cc 12v 9 denti d.11,4 rotazione dx

RIFERIMENTO ORIGINALE

Sym	31200H9A000
-----	-------------

Peugeot	801068
---------	--------

APPLICABILITÀ

Sym GTS Joymax 125 125 4T 06-07, HD EU3 125 125 4T-4V 07-08, HD EVO 125 125 4T-4V 05-06, HD EVO EU3 125 125 4T-4V 07-08, HD EVO EU3 125 125 4T-4V 10-11, HD EVO Tamburo EU3 125 125 4T-4V 08-09, HD2 125 125 4T-4V 11-11, JoyRide 125 125 4T-4V 01-02, JoyRide EU2 125 125 4T-4V 05-06, JoyRide EU3 125 125 4T-4V 07-07, JoyRide EVO 125 125 4T-4V 09-10, JoyRide 150 150 4T-4V 01-02



cod. MA00006

Motorino avv. Honda Mitsuba sm14 12v/0,45kw 9 denti d.11,7 rotazione dx

RIFERIMENTO ORIGINALE

Honda	31200-KGF-901
-------	---------------

APPLICABILITÀ

Honda @ [NES] 125 125 4T 00-06, Dylan 125 [SES] 125 4T 02-04, PS I 125 [PES] 125 4T 06-10, Pantheon 125 IE [FES] 125 4T-2V 03-05, SH 125 125 4T-2V 01-04, SH IE 125 Scoopy 125 4T-2V 05-12, Silver Wing 125 [FES] 125 4T-2V 07-12, @ [NES] 150 150 4T 00-06, Dylan 150 [SES] 150 4T 02-04, PS I 150 [PES] 150 4T 06-10, Pantheon 150 IE [FES] 150 4T-2V 03-05, SH 150 150 4T-2V 01-04, SH IE 150 Scoopy 150 4T 05-12, Silver Wing 150 [FES] 150 4T-2V 07-12

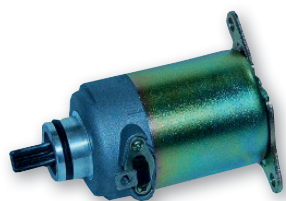

cod. MA00007

Motorino avviamento Sym125cc 12v rotazione dx

RIFERIMENTO ORIGINALE

Kymco	00126011
Kymco	00128741
Malaguti	54800100

Sym	31200M92100
Sym	31200ARA000

APPLICABILITÀ

Kymco Agility 125 125 4T 06-06, Agility 125 EU3 125 4T 06-08, Agility 125 R16 125 4T 08-09, Agility 125 RS 125 4T 09-09, B&W 125 125 4T 00-00, B&W 125 EU2 125 4T 03-04, Dink 125 125 4T 97-98, Dink Classic 125 125 4T 02-02, Dink Classic 125 EU2 125 4T 03-03, Dink LX 125 125 4T 98-00, Heroism 125 125 4T 95-97, Like 125 125 4T 09-09, Movie 125 125 4T 99-00, Movie 125 EU3 125 4T 06-07, Movie XL 125 EU2 125 4T 03-04, People 125 125 4T 99-00, People 125 EU2 125 4T 03-03, People 125 EU3 125 4T 07-08, People EU3 125 4T 11-11, People S 125 125 4T 05-05, People S DD EU3 125 125 4T 07-08, Super 8 125 125 4T 08-09, Vivio 125 125 4T 00-00, Agility 150 150 4T 06-08, Agility 150 R16 150 4T 08-09, B&W 150 150 4T 00-00, B&W 150 EU2 150 4T 03-04, Dink 150 150 4T 97-98, Dink Classic 150 150 4T 02-02,

Dink Classic 150 EU2 150 4T 03-03, Dink LX 150 150 4T 98-00, Heroism 150 150 4T 95-97, Movie 150 EU3 150 4T 06-07, Movie XL 150 EU2 150 4T 03-04, People 150 150 4T 99-00, People 150 EU2 150 4T 03-03, Vivio 150 150 4T 00-00, Agility 200 R16 200 4T 10-10, Agility R16 200 4T 12-12, Dink Classic 200 200 4T 04-04, Like 200 IE 200 4T 09-09, Like LX 200 4T 12-12, People S 200 200 4T 05-05, People S 200 I 200 4T 07-07

Malaguti Ciak 125 125 4T 00-01, Ciak Master EU3 125 125 4T 06-06, Ciak Master 125 125 4T 04-04, Ciak Restyking EU2 125 125 4T 03-03, F18 Warrior 125 125 4T 00-02, Ciak 150 150 4T 00-02, Ciak Master 150 150 4T 04-04, Ciak Restyking EU2 150 150 4T 03-03, F18 Warrior 150 150 4T 00-02, Ciak Master 200 EU2 200 4T 06-06

Sym Euro MX 125 125 4T 02-02, Euro MX EU2 125 125 4T 03-04, Shark 125 125 4T 99-02, Symphony 125 125 4T 09-09, Symphony DD 125 125 4T 09-09, Symphony S 125 125 4T 10-10, Symphony SR 125 125 4T 10-10, Euro MX 150 150 4T 02-02, Euro MX EU2 150 150 4T 03-04, Shark 150 150 4T 00-01, Symphony 150 150 4T 09-09, Symphony S 150 150 4T 10-10, Symphony SR 150 150 4T 10-10



cod. MA00010

Motorino avviamento Yamaha 250 cc 12v 9 denti Ø 11,7 rotazione dx

RIFERIMENTO ORIGINALE

Aprilia	AP8122628
Benelli	R19040191A0
Malaguti	94800100

Malaguti	74800500
Yamaha	4HC818900000
Yamaha	1COH18000000

APPLICABILITÀ

Aprilia Leonardo 250 250 4T 99-04, Leonardo 250 ST 250 4T 01-01, Leonardo 300 300 4T 02-04

Benelli Velvet 250 250 4T 99-03

Italjet Jupiter 250 250 4T 00-00

Malaguti Madison S 250 250 4T 99-01, Password 250 250 4T 05-06, Password 250 EU3 250 4T 07-08

Mbk Skyliner 250 250 4T 00-03, Skyliner 250 ABS 250 4T 03-03, Kilibre 300 300 4T 03-06

Yamaha Majesty 250 250 4T 96-03, Majesty 250 ABS 250 4T 03-03, Majesty 250 DX 250 4T 98-99, X-City 250 250 4T 07-12, X-Max 250 250 4T 05-11, Versity 300 300 4T 03-06, Majesty 400 400 4T 04-11, Majesty 400 ABS 400 4T 07-11

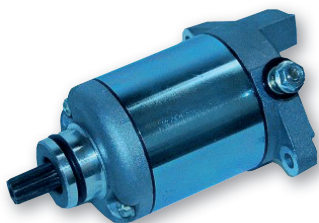

◀ cod. **MA00012**
Motorino avviamento Piaggio 50 cc 12v/0,45kw rotazione sx 4 spazzole

RIFERIMENTO ORIGINALE

Piaggio	82611R
---------	--------

APPLICABILITÀ

Aprilia Atlantic 125 125 4T 03-05, Atlantic 125 EU3 125 4T 06-08, Atlantic 125 EU3 125 4T 10-12, Mojito 125 125 4T 03-08, SR Motard 125 125 4T-2V 12-12, Scarabeo 125 125 4T 03-06, Scarabeo EU3 125 125 4T 06-07, Sport City Street 125 125 4T 12-12, Sportcity 125 125 4T 04-06, Sportcity 125 EU3 125 4T 06-08, Sportcity Cube 125 125 4T 08-10, Sportcity One 4T EU3 125 125 4T 08-11

Derbi Boulevard 125 125 4T 02-04, Boulevard 125 EU3 125 4T 04-07, Boulevard 4T EU3 125 4T 08-12, GP1 125 EU 2 125 4T 06-06, GP1 Low Seat EU3 125 4T 07-08, Rambla 125 125 4T 08-09, Rambla 125 EU3 2VER 125 4T 08-08, Sonar 4T 125 125 4T 09-11, Variant Sport 4T EU3 125 4T 12-12, Boulevard 150 150 4T 02-04, Boulevard 150 EU3 150 4T 04-07, Boulevard 4T E3 150 4T 10-10, Sonar 4T 150 150 4T 09-09, Boulevard 200 EU2 200 4T 05-06

Gilera DNA 125 125 4T 01-01, Nexus 125 EU3 125 4T 07-08, Runner 4T ST EU3 125 125 4T 08-13, Runner VX 125 125 4T 00-06, Runner VX 4T EU3 125 125 4T 06-07, Runner VX Race 125 125 4T 06-06, Runner VX SC 125 4T 06-07, Runner VXR Race 200 125 4T 06-06, DNA 180 180 4T 01-01, Runner VXR 180 180 4T 00-01, Runner VXR 200 200 4T 02-06, Runner VXR 4T ST EU3 200 200 4T 08-11, Runner VXR EU3 200 200 4T 07-07

Piaggio Beverly 125 125 4T 01-03, Beverly 125 EU3 125 4T 07-08, Beverly 125 EURO 3 MIC 125 4T 07-07, Beverly 125 EURO 3 SPORT 125 4T 07-08, Beverly 125 Tourer EU3 125 4T 07-10, Beverly RST 125 125 4T 04-07, Carnaby 125 125 4T 07-10, Fly 125 125 4T 05-07, Fly 125 EU3 125 4T 07-11, Hexagon GTX 125 125 4T 00-00, Liberty 125 125 4T 01-02, Liberty 125 4T 125 4T 06-07, Liberty 125 4T EU3 125 4T 07-08, Liberty 125 4T EU3 Delivery - TNT 125 4T 08-15,

Liberty 125 4T Sport EU3 125 4T 06-08, Liberty 125 Sport 125 4T 06-06, Liberty 4T 2V Euro3 125 4T 09-12, Liberty RST 125 125 4T 04-05, MP3 125 125 4T 06-08, Skypper 125 4T 125 4T 00-02, Super Hexagon GTX 12 125 125 4T 01-02, Typhoon 125 4T 2V E3 125 4T 10-11, Vespa ET4 125 125 4T 99-02, Vespa GRANTURISMO 125 125 4T 03-07, Vespa GRANTURISMO 125 EU3 125 4T 06-07, Vespa GTS 125 EU3 125 4T 07-12, Vespa GTV 125 125 4T 06-08, Vespa GTV 4T NAVY EU3 125 125 4T 08-08, Vespa LX 125 125 4T 05-06, Vespa LX 4T EU3 TOURING 125 4T 10-11, Vespa LX 4T FL 125 4T 09-09, Vespa LX EU3 125 4T 06-08, Vespa LX EU3 IE 125 4T 09-10, Vespa LXV 4T EU3 125 4T 06-09, Vespa LXV IE 4T 125 4T 10-12, Vespa LXV NAVY EU3 125 4T 07-08, Vespa S 4T 125 EU3 125 4T 07-08, Vespa S 4T IE & COLLEGE 125 4T 09-11, X-Evo 125 125 4T 07-16, X7 125 EU3 125 4T 08-08, X8 125 125 4T 04-06, X8 125 Premium EU2 125 4T 06-06, X8 125 Premium EU3 125 4T 06-07, X8 Street 125 EU2 125 4T 06-07, X9 125 125 4T 01-02, X9 Evolution 125 125 4T 03-03, X9 Evolution 125 125 4T 05-06, X9 Evolution EU3 125 125 4T 07-07, Zip 125 125 4T 00-02, Fly 150 150 4T 05-07, Fly 150 EU3 150 4T 08-11, Liberty 150 4T EU3 150 4T 08-08, Liberty 150 4T Sport EU3 150 4T 08-08, Liberty 150 Moc 4T 150 4T 09-13, Skypper 150 4T 150 4T 00-02, Vespa ET4 150 150 4T 99-02, Vespa LX 150 150 4T 05-06, Vespa LX 4T FL 150 4T 09-09, Vespa LX EU3 150 4T 06-08, Vespa LX EU3 IE 150 4T 09-11, Vespa LX TOURING 150 4T 10-12, Vespa S 4T 150 150 4T 08-09, Vespa S 4T IE & COLLEGE 150 4T 09-11, X8 Street 150 EU2 150 4T 06-08, Hexagon GTX 180 180 4T 00-00, Super Hexagon GTX 12 180 180 4T 01-02, X9 Amalfi 180 180 4T 00-03, Carnaby 200 200 4T 07-08, Liberty 200 200 4T 06-06, Liberty 200 4T EU3 200 4T 06-08, Liberty 200 4T Sport EU3 200 4T 06-07, Liberty 200 Sport 200 4T 06-06, Liberty RST 200 200 4T 04-04, Vespa GRANTURISMO 200 200 4T 03-07, X8 200 200 4T 05-07, X9 200 200 4T 02-03, X9 Evolution 200 200 4T 03-03



◀ cod. **MA00013**
Motorino avviamento Piaggio 12v rotazione sx

RIFERIMENTO ORIGINALE

Piaggio	430554
---------	--------

Cagiva	8000093633
--------	------------

APPLICABILITÀ

Aprilia Mojito Retró Custom 125 4T 99-01
Cagiva Cucciolo 125 125 4T 00-00

Piaggio Hexagon LX4 125 125 4T 98-99, Liberty 125 125 4T 98-00, Sfera 125 4T 95-97, Vespa ET4 125 125 4T 96-98



◀ cod. **MA00014**
Motorino avviamento Kymco 50 cc 12v/0,20kw rotazione sx

RIFERIMENTO ORIGINALE

Kymco	00104202
-------	----------

Sym	31200GAK900
-----	-------------

APPLICABILITÀ

Kymco Bet & Win 50 2T 02-02, Bet & Win EU2 50 2T 03-03, Dink LC 50 2T 98-02, Dink Classic EU2 50 2T 03-03, Filly 50 4T 98-00, Heroism 50 2T 95-97, KXR 50 50 2T 04-04, MXU 50 50 2T 06-07, MXU SR 50 50 2T 06-06, Maxxer 50 50 2T 05-05, Mxer 50 50 2T 02-03, Mxer EU2 50 50 2T 04-04, People 50 2T 99-04, People Euro 2 50 2T 03-03, People Euro 2 50 2T 08-08, People Euro 2 50 2T 11-11, People S 50 2T 05-08, Sniper 50 2T 93-93, Sniper DD 50 2T 94-96, Super 9 50 2T 00-00, Super 9 EU2 50 2T 03-04, Top Boy 50 2T 97-00, Vitality 2T 50 2T 04-04, Yup 50 2T 02-02, Yup EU2 50 2T 03-03

Sym Jet 50 2T 99-01, Jungle 50 2T 99-00, Mask 50 2T 00-01, Mask EU2 50 2T 03-04, Red Devil 50 2T 99-99, Super Fancy 50 2T 98-00

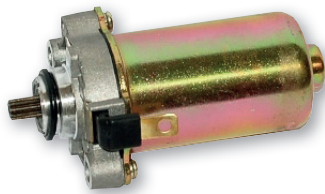

cod. **MA00015**

Motorino avviamento Piaggio 50 cc 12v/0,25kw 10 denti rotazione sx

RIFERIMENTO ORIGINALE

Piaggio	96921R
---------	--------

Malaguti	44800500
----------	----------

APPLICABILITÀ

Aprilia RS 50 50 2T 06-10, RS4 50 2T 11-13, SR R 50 2T 04-09, SR R FACTORY IE 50 2T -, Scarabeo 4T 50 4T 02-06, Scarabeo 4T 4V 50 4T-4V 10-12, Scarabeo 4T 4V NET 50 4T-4V 09-10, Scarabeo 4T Restyling EU3 50 4T 06-09, Scarabeo Quattro 50 4T-4V 09-09, Sport City One 4T 50 4T 08-10

Derbi Atlantis 4T 50 4T 04-06, Atlantis 4T EU2 50 4T 07-07, Boulevard 4T EU2 25KM/H 50 4T -, GPR 2T EU2 50 2T 09-10, GPR NUDE & GPR NUDE Tuning 50 2T 06-08, GPR NUDE Sport 50 2T 06-06, GPR R EU2 - GPR Replica EU2 50 2T 08-08, GPR Racing EU2 50 2T 06-06, GPR Replica & GPR R EU2 50 2T 06-06, GPR Replica 2T Malossi 50 2T 07-07, GPR Replica Pesek EU2 50 2T 07-07, Senda R DRD PRO EU2 50 2T 05-11, Senda SM DRD PRO EU2 50 2T 05-11

Gilera Runner Pure Jet 50 2T-IE 02-07, Runner Pure Jet 50 2T-IE 10-11, Runner Pure Jet ST 50 2T-IE 08-08

Malaguti Centro Euro 2 50 4T 08-08, Centro SL 4T 50 4T 10-10, Ciak Master 4T 50 4T 05-06

Piaggio Fly 4T 50 4T 05-07, Fly 4T & 25-30 KM/H 50 4T 08-11, Fly 4T Motore CHN 50 4T 06-07, Liberty 4T 50 4T 00-02, Liberty 4T 50 4T 05-08, Liberty 4T Delivery - Single 50 4T 10-12, Liberty 4T Delivery TNT 50 4T 09-09, Liberty 4T PTT - DOUBLE 50 4T 09-12, Liberty 4T RST 50 4T 04-04, Liberty 4T Sport 50 4T 06-08, Liberty MOC 2T & Elle 50 2T -, NRG Power Pure Jet 50 2T-IE 04-05, NRG Power PureJet 50 2T-IE 06-11, NRG PureJet 50 2T-IE 02-04, NRG PureJet 50 2T-IE 10-10, Vespa ET4 50 4T 00-05, Vespa LX 4T 50 4T 05-08, Vespa LX 4T 4V 50 4T-4V 09-11, Vespa LX 4T 4V Touring 50 4T-4V 10-11, Vespa S 4T 4V & College 50 4T-4V 08-11, Zip 4T 50 4T 00-13, Zip RST 50 2T 96-99, Diesis 100 100 2T 01-01

cod. **MA00016**

Motorino avviamento Piaggio 125/250/300 cc 12v/0,45kw 9 denti Ø 11,7 rotazione dx

RIFERIMENTO ORIGINALE

Piaggio	58142R
---------	--------

APPLICABILITÀ

Aprilia SR MAX 125 125 4T 11-14, Atlantic 250 250 4T 03-05, Atlantic 250 EU3 250 4T 06-08, Scarabeo 250 250 4T 04-06, Scarabeo Light 250 250 4T 06-08, Sportcity 250 EU3 250 4T 06-08, Sportcity Cube 250 250 4T 08-12, Atlantic 300 300 4T 10-11, SR MAX 300 300 4T 11-14, Scarabeo Light 300 300 4T 09-10, Sprot City Street 300 300 4T-4V 12-12

Derbi GP1 250 250 4T 06-07, GP1 250 Low Seat EU3 250 4T 07-08, Rambla 250 250 4T 08-09, Rambla 250 EU3 2VER 250 4T 08-08, Rambla 300 300 4T 10-11

Gilera Nexus 125 IE EU3 125 4T 08-10, Nexus 250 EU3 250 4T 06-07, Nexus SP 250 EU3 250 4T 06-07, Oregon 250 250 4T 06-10, Nexus 300 EU3 300 4T 08-11

Piaggio Vespa GTS 4T IE SUPER 125 4T 09-16, X7 Evo 125 IE EU3 125 4T 09-10, Beverly 250 250 4T 06-07, Beverly 250 CRUISER 250 4T 07-09, Beverly 250 Tourer EU3 250 4T 07-09, Beverly 250 IE EU3 250 4T 06-08, Beverly RST 250 250 4T 04-05, Carnaby 250 250 4T 08-08, MP3 250 250 4T 06-08, MP3 250 LT 250 4T 08-09, MP3 250 MIC 250 4T 08-09, Vespa GT 60 250 EU3 250 4T 06-07, Vespa GTS 250 250 4T 05-16, Vespa GTS ABS 250 250 4T 05-12, Vespa GTV 250 250 4T 06-09, Vespa GTV 4T NAVY EU3 250 250 4T 07-07, X-Evo 250 250 4T 07-16, X7 250 EU3 250 4T 08-08, X8 250 EU3 250 4T 05-08, X9 Evolution 250 250 4T 04-04, X9 Evolution 250 250 4T 06-06, Beverly 300 RST 4T 4V IE EU3 300 4T 10-15, Beverly Tourer 300 EU3 300 4T 09-10, Carnaby Cruiser 300 300 4T 09-12, Vespa GTS IE Touring 300 300 4T 11-12, Vespa GTS Super 300 4T 08-15, Vespa GTS Super Sport 300 4T 10-13, Vespa GTV 4T 4V IE 300 300 4T 10-13, Vespa GTV VIA MONTENAPOLEONE 300 4T 10-10, X7 Evo 300 IE EU3 300 4T 09-10

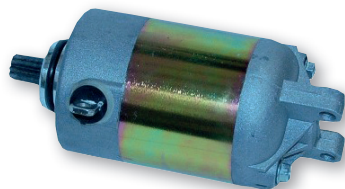

cod. **MA00017**

Motorino avviamento Minarelli 125/150/180cc 12v 9 denti Ø 11,5 rotazione sx

RIFERIMENTO ORIGINALE

Benelli	R19010111A0
Malaguti	74800400
Yamaha	4CWH18000000
Yamaha	5MLH18000000

Yamaha	5DSH18000000
Yamaha	5DS818000000
Yamaha	5XLH18000000

APPLICABILITÀ

Benelli Velvet 125 125 4T 99-01, Velvet 125 Touring 125 4T 02-03, Velvet 150 150 4T 99-01, Velvet 150 Touring 150 4T 02-03

Italjet Jupiter 125 125 4T -00, Millennium 125 125 4T -00, Jupiter 150 150 4T -00, Millennium 150 150 4T -00

Malaguti Madison 125 125 4T 99-01, Madison R Restyling 125 125 4T 02-02, Madison R Restyling 125 EU2 125 4T 03-04, Phantom Max 125 125 4T 03-03, Madison T 150 150 4T 99-01

Mbk Doodo 125 125 4T 00-00, Skyliner 125 125 4T 98-02, Skyliner E 125 125 4T 03-03, Thunder 125 125 4T 01-02, Doodo 150 150 4T 01-02, Skyliner 150 150 4T 00-02, Thunder 150 150 4T 01-02, Skyliner E 180 180 4T 03-03

Yamaha Cygnus R 125 (XC K) 125 4T 97-98, Cygnus R 125 (XC) 125 4T 99-99, Cygnus X 125 (NXC) 125 4T 04-06, Cygnus 125 (XC T) 125 4T 95-98, Majesty 125 125 4T 98-02, Majesty 125 E 125 4T 03-09, Majesty 125 125 4T 01-02, Teo's 125 125 4T 00-00, Majesty 150 150 4T 00-02, Maxter 150 150 4T 01-02, Teo's 150 150 4T 01-02, Majesty 180 E 180 4T 03-06

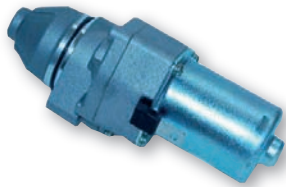

◀ cod. **MA00018**
Motorino avviamento Minarelli AM 345/6

RIFERIMENTO ORIGINALE

Aprilia	AP8212367
Piaggio	4800180

Piaggio	2402700
Yamaha	4YVH18002000

APPLICABILITÀ

Aprilia Classic 50 2T 92-99, Europa 50 2T 91-92, Pegaso 50 2T 92-94, RS 50 50 2T 91-05, Tuono 50 50 2T 03-04
HM Baja, Derapage Basic 50 2T 10-11, CRE Baja RR, Derapage RR 50 2T 07-11, CRE Baja, Derapage 50 2T 07-11, CRE Six, Baia, Derapage 50 2T 95-00, CRE Six, Baia, Derapage 50 2T 03-06, Derapage Competition 50 2T 10-11

Malaguti Fifty Evolution 50 2T 90-93
Yamaha TZR 50 2T 03-08, TZR 50 2T 10-11, TZR RR 50 2T 05-05



◀ cod. **MA00019**
Motorino avviamento Peugeot 50 cc 12v/0,15kw 11 denti rotazione sx con cavi

RIFERIMENTO ORIGINALE

Peugeot	744049
---------	--------

APPLICABILITÀ

Peugeot Buxy 50 2T -00, Elyseo 50 2T -00, Kisbee 50 2T -00, Looxor 50 2T -00, Ludix 50 2T -00, Metal X 50 2T -00, Speedake 50 2T -00, Speedfight 50 2T -00, Speedfight 3 50 2T -00, Squab 50 2T -00, Trekker 50 2T -00, Vivacity 50 2T -00, X-Fight 50 2T -00, Zenith 50 2T -00



◀ cod. **MA00021**
Motorino avviamento Suzuki 125/150/250/400 cc

RIFERIMENTO ORIGINALE

Suzuki	31100-14F01-000
--------	-----------------

APPLICABILITÀ

Suzuki Epicuro 125 125 4T 99-01, UH Burgman 125 K2/K6 125 4T 02-06, Epicuro 150 150 4T 99-01, UH Burgman 150 K2/K6 150 4T 02-06, AN Burgman 250 K3/K6 250 4T 03-06, AN Burgman 250 W/K2 250 4T 98-02, AN Burgman 400 K3/K6 400 4T 03-06, AN Burgman 400 X/K2 400 4T 99-02



◀ cod. **MA00022**
Motorino avviamento Aprilia Leonardo/Scarabeo 125 (Rotax)

RIFERIMENTO ORIGINALE

Aprilia	AP0296390
---------	-----------

Malaguti	65030700
----------	----------

APPLICABILITÀ

Aprilia Leonardo 125 125 4T 96-02, Leonardo ST 125 4T 03-04, Scarabeo 125 125 4T 99-03, Leonardo 150 150 4T 96-02, Scarabeo 150 150 4T 99-03, Scarabeo 200 200 4T 01-03

Malaguti Blog 125 125 4T 11-11, Blog 125 IE 125 4T 09-10, Centro 125 IE EU3 125 4T 08-09, Centro SL 125 125 4T 11-11, Centro SL 125 IE EU3 125 4T 09-10, Blog 160 160 4T 11-11, Blog 160 IE 160 4T 09-10, Centro 160 IE EU3 160 4T 08-09, Centro SL 160 160 4T 11-11, Centro SL 160 IE EU3 160 4T 09-10

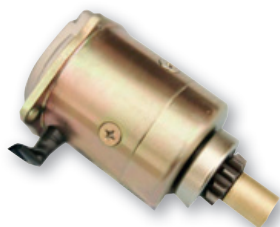

◀ cod. **MA00023**
Motorino avviamento Piaggio Vespa/Ape 50

RIFERIMENTO ORIGINALE

Piaggio	179116
---------	--------

APPLICABILITÀ

Piaggio Ape 50 TM P 50 2T 85-89, Ape EU2 50 2T 03-10, Ape FL - FL2 50 2T 89-95, Ape FL3 50 2T 96-99, Ape RST MIX 50 2T 99-03, Vespa FL 50 2T 90-90, Vespa FL2 AUTOMATICA 50 2T 90-91, Vespa FL2 HP 50 2T 91-97, Vespa N 50 2T 89-90, Vespa PK 50 2T 82-84, Vespa PK AUTOMATICA 50 2T 84-89, Vespa PK XL 50 2T 85-88, Vespa PK XL PLURIMATIC 50 2T 85-90, Vespa PK XL RUSH 50 2T 88-89, Vespa FL 125 125 2T 89-90



◀ cod. **MA00024**
Motorino Avviamento Peugeot Sym 50cc 4T

APPLICABILITÀ

Sym M10 50 4T 06-09, Symphony Euro 2 50 4T 09-09, Symphony S 50 4T 10-10, Symphony SR 50 4T 10-10



◀ cod. **MA00025**
Motorino Avviamento Kymco Agility/ People 50cc 4T

RIFERIMENTO ORIGINALE

Kymco	107242
-------	--------

APPLICABILITÀ

Kymco Agility 4T Carry 50 4T 11-11, Agility 4T R10 50 4T 06-08, Agility 4T R12 50 4T 07-08, Agility R12 50 4T 05-05, Agility R16 50 4T 08-09, Agility R16 50 4T 12-12, Agility RS 50 4T 09-09, Dink Euro 2 50 4T 07-07, Filly 50 4T 98-00, Filly LX 50 4T 01-02, Like 50 4T 09-09, People S 4T 50 4T 06-08, Sento 50 4T 08-08, Super 8 4T 50 4T 07-07, Super 8 4T 50 4T 09-09

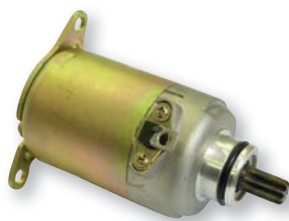

◀ cod. **MA00026**
Motorino Avviamento Sym Symphony 125/150cc

RIFERIMENTO ORIGINALE

Sym	31200-ARA-000	Sym	31200-M92-100
-----	---------------	-----	---------------

APPLICABILITÀ

Sym Euro MX 125 125 4T 02-02, Euro MX EU2 125 125 4T 03-04, Shark 125 125 4T 99-02, Symphony 125 125 4T 09-09, Symphony S 125 125 4T 09-10, Symphony SR 125 125 4T 10-10, Euro MX 150 150 4T 02-02, Euro MX EU2 150 150 4T 03-04, Shark 150 150 4T 00-01, Symphony 150 150 4T 09-09, Symphony S 150 150 4T 10-10, Symphony SR 150 150 4T 10-10



◀ cod. **MA00027**
Motorino Avviamento Kymco Dink 125/200cc EU3

RIFERIMENTO ORIGINALE

Kymco	128751
-------	--------

APPLICABILITÀ

Kymco Dink 125 EU3 125 4T 06-07, G-DINK 125 4T 12-12, Grand Dink 125 125 4T 01-02, Grand Dink 125 EU2 125 4T 03-04, Grand Dink 150 150 4T 01-02, Grand Dink 150 EU2 150 4T 03-04

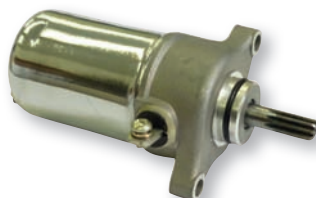

◀ cod. **MA00028**
Motorino Avviamento Yamaha X-MAX 125cc

RIFERIMENTO ORIGINALE

Yamaha	1B9H18000100
--------	--------------

APPLICABILITÀ

Mbk Cityliner 125 EU3 125 4T-4V 08-10, Skycruiser 125 125 4T-4V 07-07

Yamaha X-City 125 EU3 125 4T-4V 08-11, X-Max R 125 ABS 125 4T-4V 11-11, X-Max R 125 EU3 125 4T-4V 06-12



◀ cod. **MA00029**
Motorino Avviamento Piaggio Vespa PX 125cc

RIFERIMENTO ORIGINALE

Piaggio	249235
---------	--------

APPLICABILITÀ

Piaggio Vespa PX 125 125 2T 98-01, Vespa PX 125 125 2T 11-16, Vespa PX 125 EU2 125 2T 01-07, Vespa PX 30 Anni 125 2T 07-08, Vespa PX E 125 Arcobaleno 125 2T 81-97, Cosa CL, CLX 150 2T 88-91, Vespa PX 150 150 2T 98-01, Vespa PX 150 150 2T 11-16, Vespa PX E 150 Arcobaleno 150 2T 81-97, Vespa PX E 200 Arcobaleno 200 2T 81-97



◀ cod. **MC12000**
Membrana carburatore per scooter Minarelli/Yamaha 125/150 cc

RIFERIMENTO ORIGINALE

Yamaha	5DS1434A1000
--------	--------------

APPLICABILITÀ

Benelli	Velvet 125 125 4T 99-01, Velvet 150 150 4T 99-01	Mbk	Doodo 125 125 4T 00-00, Skyliner 125 125 4T 98-02, Thunder 125 125 4T 01-02, Doodo 150 150 4T 01-02, Thunder 150 150 4T 01-02
Italjet	Jupiter 125 125 4T -00, Millenium 125 125 4T -00, Jupiter 150 150 4T -00, Millenium 150 150 4T -00	Yamaha	Majesty 125 125 4T 98-02, Maxter 125 125 4T 01-02, Teo's 125 125 4T 00-00, Majesty 150 150 4T 00-02, Maxter 150 150 4T 01-02, Teo's 150 150 4T 01-02
Malaguti	Madison 125 125 4T 99-01, Madison R Restyling 125 125 4T 02-02, Phantom Max 125 125 4T 03-03, Madison T 150 150 4T 99-01		



◀ cod. **MC12001**
Membrana carburatore per scooter Minarelli/Yamaha 250/300 cc

RIFERIMENTO ORIGINALE

Yamaha	4HC143400100
--------	--------------

APPLICABILITÀ

Aprilia	Leonardo 250 250 4T 99-04, Leonardo 250 ST 250 4T 01-01, Leonardo 300 300 4T 02-04	Mbk	Skyliner E 125 125 4T 03-03, Skyliner E 180 180 4T 03-03, Skyliner 250 250 4T 00-03, Skyliner 250 ABS 250 4T 03-03, Kilibre 300 300 4T 03-06
Benelli	Velvet 250 250 4T 99-03	Yamaha	Majesty 125 E 125 4T 03-09, Majesty 180 E 180 4T 03-06, Majesty 250 250 4T 96-03, Majesty 250 ABS 250 4T 03-03, Majesty 250 DX 250 4T 98-99, Versity 300 300 4T 03-06
Italjet	Jupiter 250 250 4T 00-00		
Malaguti	Madison R Restyling 125 EU2 125 4T 03-04, Madison S 250 250 4T 99-01		

◀ cod. **MC12002**
Membrana carburatore per scooter Piaggio 125 cc

RIFERIMENTO ORIGINALE

Piaggio	CM140501
---------	----------

APPLICABILITÀ

Aprilia	Mojito 125 125 4T 03-08, Mojito 150 150 4T 03-07	Piaggio	Beverly 125 125 4T 01-03, Hexagon GTX 125 125 4T 00-00, Liberty 125 125 4T 98-02, Skypper 125 4T 125 4T 00-02, Vespa ET4 125 125 4T 96-02, X9 125 125 4T 01-02, Zip 125 125 4T 00-02, Liberty 150 150 4T 01-02, Skypper 150 4T 150 4T 00-02, Vespa ET4 150 150 4T 99-02, Hexagon GTX 180 180 4T 00-00
Derbi	Boulevard 125 EU3 125 4T 04-07, Boulevard 150 150 4T 03-04		



◀ cod. **MC12004**
Membrana Carburatore Honda SH 125/150cc

APPLICABILITÀ

Honda	@ [NES] 125 125 4T 00-06, Dylan 125 [SES] 125 4T 02-04, SH 125 125 4T-2V 01-04, @ [NES] 150 150 4T 00-06, Dylan 150 [SES] 150 4T 02-04, SH 150 150 4T-2V 01-04
--------------	--

RIFERIMENTO ORIGINALE

Honda	16111-KFG-911
-------	---------------



◀ cod. **MC12005**
Membrana Carburatore Sym Symphony 125-150cc

APPLICABILITÀ

Sym	Symphony S 125 125 4T 12-14, Symphony SR 125 125 4T 12-12, Symphony S 150 150 4T 12-14, Symphony SR 150 150 4T 12-12
------------	--

RIFERIMENTO ORIGINALE

Sym	1614227A000
-----	-------------



◀ cod. **MC12100**
Membrana Carburatore Adattabile a Yamaha Majesty 125-150cc '98-'02

APPLICABILITÀ

Benelli	Velvet 125 125 4T 99-01, Velvet 150 150 4T 99-01	Mbk	Doodo 125 125 4T 00-00, Skyliner 125 125 4T 98-02, Thunder 125 125 4T 01-02, Doodo 150 150 4T 01-02, Thunder 150 150 4T 01-02
Italjet	Jupiter 125 125 4T -00, Millenium 125 125 4T -00, Jupiter 150 150 4T -00, Millenium 150 150 4T -00	Yamaha	Majesty 125 125 4T 98-02, Maxter 125 125 4T 01-02, Teo's 125 125 4T 00-00, Majesty 150 150 4T 00-02, Maxter 150 150 4T 01-02, Teo's 150 150 4T 01-02
Malaguti	Madison 125 125 4T 99-01, Madison R Restyling 125 125 4T 02-02, Phantom Max 125 125 4T 03-03, Madison T 150 150 4T 99-01		



◀ cod. **MC12101**
Membrana Carburatore adattabile a scooter Minarelli/Yamaha 250/300cc

APPLICABILITÀ

Aprilia	Leonardo 250 250 4T 99-04, Leonardo 250 ST 250 4T 01-01, Leonardo 300 300 4T 02-04	Mbk	Skyliner E 125 125 4T 03-03, Skyliner E 180 180 4T 03-03, Skyliner 250 250 4T 00-03, Skyliner 250 ABS 250 4T 03-03, Kilibre 300 300 4T 03-06
Benelli	Velvet 250 250 4T 99-03	Yamaha	Majesty 125 E 125 4T 03-09, Majesty 180 E 180 4T 03-06, Majesty 250 250 4T 96-01, Majesty 250 250 4T 02-03, Majesty 250 ABS 250 4T 03-03, Majesty 250 DX 250 4T 98-99, Versity 300 300 4T 03-06
Italjet	Jupiter 250 250 4T 00-00		
Malaguti	Madison R Restyling 125 EU2 125 4T 03-04, Madison S 250 250 4T 99-01		

RIFERIMENTO ORIGINALE

Yamaha	4HC143400100
--------	--------------



◀ cod. **MC12103**
Membrana Carburatore adattabile a Kymco Agility 125/150cc

APPLICABILITÀ

Kymco	Agility 125 125 4T 06-06, Agility 125 R16 125 4T 08-09, Dink 125 EU3 125 4T 06-07, Like 125 125 4T 09-09, Movie 125 EU3 125 4T 06-07, Movie XL 125 EU2 125 4T 03-04, People 125 EU2 125 4T 03-03, People 125 EU3 125 4T 07-08, People EU3 125 4T 11-11, People S 125 125 4T 05-05, People S DD EU3 125 125 4T 07-08, Super 8 125 125 4T 08-08, Agility 150 R16 150 4T 08-09, Movie 150 EU3 150 4T 06-07, Movie XL 150 EU2 150 4T 03-04, People 150 EU2 150 4T 03-03, Like LX 200 4T 12-12, People S 200 200 4T 05-05
--------------	--



◀ cod. **MC12104**
Membrana Carburatore adattabile a Honda SH 125/150cc

APPLICABILITÀ

Aprilia	Leonardo 250 250 4T 99-04, Leonardo 250 ST 250 4T 01-01, Leonardo 300 300 4T 02-04	Mbk	Skyliner E 125 125 4T 03-03, Skyliner E 180 180 4T 03-03, Skyliner 250 250 4T 00-03, Skyliner 250 ABS 250 4T 03-03, Kilibre 300 300 4T 03-06
Benelli	Velvet 250 250 4T 99-03	Yamaha	Majesty 125 E 125 4T 03-09, Majesty 180 E 180 4T 03-06, Majesty 250 250 4T 96-01, Majesty 250 250 4T 02-03, Majesty 250 ABS 250 4T 03-03, Majesty 250 DX 250 4T 98-99, Versity 300 300 4T 03-06
Italjet	Jupiter 250 250 4T 00-00		
Malaguti	Madison R Restyling 125 EU2 125 4T 03-04, Madison S 250 250 4T 99-01		

RIFERIMENTO ORIGINALE

Honda	16111-KGF-911
-------	---------------



◀ cod. **PL04055**
Puleggia fissa anteriore per motori scooter 50 cc Minarelli/Yamaha

◀ cod. **PL04056**
Puleggia fissa anteriore per motori per scooter 50 cc Minarelli/Yamaha completa di piastrina



◀ cod. **PL04058**
Puleggia fissa anteriore per motori scooter 50 cc Gilera/Piaggio



◀ cod. **PL04060**
Puleggia fissa anteriore per motori scooter Gilera/Piaggio 125/150 cc ø esterno 142 mm



◀ cod. **PL04061**
Puleggia fissa anteriore per motori scooter 180 cc 4T Piaggio

RIFERIMENTO ORIGINALE

Piaggio	832720
---------	--------



◀ cod. **PL04059**
Puleggia mobile anteriore per motori scooter 50 cc Piaggio/Gilera con masse ø 19

◀ cod. **PL04062**
Puleggia mobile per motori scooter 125/150/180 cc 4T Piaggio

RIFERIMENTO ORIGINALE

Piaggio	CM103901
---------	----------



◀ cod. **PL04063**
Puleggia fissa per motori scooter 50 cc Aprilia D.Tech

◀ cod. **PL04064**
Puleggia mobile completa per motori scooter 50 cc Aprilia D.Tech



◀ cod. **PL04066**
Piattello porta tasselli Majesty 250 cc

RICAMBIO

AA00852	Tasselli traino
---------	-----------------



◀ cod. **PL04067**
Piattello porta tasselli Piaggio 125/150/180/200 cc

RICAMBIO

AA00850	Tasselli traino
---------	-----------------

AA00851	Distanziale
---------	-------------



◀ cod. **AA00853**
Serie Tasselli di Traino Suzuki Burgman 125/250/400cc - Honda 300/400 cc

RIFERIMENTO ORIGINALE

Suzuki	21481-14F00-000
Honda	22011-KAB-000
Honda	22011-MCT-305



◀ cod. **ML06232**
Molla contrasto variatore grezza carico tipo originale per motori scooter 50 cc Minarelli/Yamaha con campana frizione ø interno 105 mm



cod. **RL00001**
Ruota libera motore scooter 50 cc Minarelli/Yamaha

RIFERIMENTO ORIGINALE

Aprilia	AP8206147
Benelli	R16140181A0

Malaguti	74012500
Yamaha	3VL155700000



cod. **RL00002**
Ruota libera scooter Minarelli/Yamaha 125/150 cc

RIFERIMENTO ORIGINALE

Yamaha	5NSE55700000
--------	--------------

Mbk	5NSE55700000
-----	--------------

APPLICABILITÀ

Benelli Velvet 125 125 4T 99-01, Velvet 150 150 4T 99-01
Italjet Jupiter 125 125 4T -00, Millenium 125 125 4T -00, Jupiter 150 150 4T -00, Millenium 150 150 4T -00
Malaguti Madison 125 125 4T 99-01, Madison R Restyling 125 125 4T 02-02, Madison R Restyling 125 EU2 125 4T 03-04, Phantom Max 125 125 4T 03-03, Madison T 150 150 4T 99-01

Mbk Doodo 125 125 4T 00-00, Flame T 125 125 4T 95-99, Skyliner 125 125 4T 98-02, Thunder 125 125 4T 01-02, Doodo 150 150 4T 01-02, Skyliner 150 150 4T 00-02, Thunder 150 150 4T 01-02
Yamaha Majesty 125 125 4T 98-02, Maxter 125 125 4T 01-02, Teo's 125 125 4T 00-00, Majesty 150 150 4T 00-02, Maxter 150 150 4T 01-02, Teo's 150 150 4T 01-02



cod. **RL00003**
Ruota libera Honda SH-Pantheon 125/150 cc 4T

RIFERIMENTO ORIGINALE

Honda	28125KG911
-------	------------

APPLICABILITÀ

Honda @ [NES] 125 125 4T 00-06, Dylan 125 [SES] 125 4T 02-04, PS I 125 [PES] 125 4T 06-10, Pantheon 125 IE [FES] 125 4T-2V 03-05, SH 125 125 4T-2V 01-04, SH IE 125 Scoopy 125 4T-2V 05-12, Silver Wing 125 [FES] 125 4T-2V 07-12, @ [NES] 150 150 4T 00-06, Dylan 150 [SES] 150 4T 02-04, PS I 150 [PES] 150 4T 06-10, Pantheon 150 IE [FES] 150 4T-2V 03-05, SH 150 150 4T-2V 01-04, SH IE 150 Scoopy 150 4T 05-12, Silver Wing 150 [FES] 150 4T-2V 07-12



cod. **RL00004**
Ruota libera Honda Foresight 250 cc 4T

RIFERIMENTO ORIGINALE

Honda	28120KM1013
-------	-------------

APPLICABILITÀ

Honda CN 250 Spazio/Helix 250 4T 86-99, Foresight 250 [FES] 250 4T 98-99, Foresight 250 [FES] D.D. 250 4T 00-05, Forza 250 [NSS] 250 4T-2V 02-07, Jazz 250 ES Reflex [NSS] 250 4T-2V 01-04, Jazz 250 Reflex [NSS] 250 4T-2V 01-01



cod. **RL00005**
Ruota libera Aprilia Scarabeo 150/200 cc 4T

RIFERIMENTO ORIGINALE

Aprilia	AP0259495
---------	-----------

APPLICABILITÀ

Aprilia Leonardo 125 125 4T 96-02, Leonardo ST 125 4T 03-04, Scarabeo 125 125 4T 99-03, Leonardo 150 150 4T 96-02, Scarabeo 150 150 4T 99-03, Scarabeo 200 200 4T 01-03, C1 125 125 4T 00-03, C1 200 200 4T 02-03
BMW C1 125 125 4T 00-03, C1 200 200 4T 02-03
Honda @ [NES] 125 125 4T 00-06, Dylan 125 [SES] 125 4T 02-04, PS I 125 [PES] 125 4T 06-10, Pantheon 125 IE [FES] 125 4T-2V 03-05, SH 125 125 4T-2V 01-04, SH IE 125 Scoopy 125 4T-2V 05-12, Silver Wing 125 [FES] 125 4T-2V 07-12, @ [NES] 150 150 4T 00-06, Dylan 150 [SES] 150 4T 02-04, PS I 150 [PES] 150 4T 06-10, Pantheon 150 IE [FES] 150 4T-2V 03-05, SH 150 150 4T-2V 01-04, SH IE 150 Scoopy 150 4T 05-12, Silver Wing 150 [FES] 150 4T-2V 07-12



cod. **RL00013**
Ingranaggio ruota libera Aprilia Scarabeo 150/200 cc 4T

RIFERIMENTO ORIGINALE

Aprilia	AP0259480
---------	-----------

APPLICABILITÀ

Aprilia Leonardo 125 125 4T 96-02, Leonardo ST 125 4T 03-04, Scarabeo 125 125 4T 99-03, Leonardo 150 150 4T 96-02, Scarabeo 150 150 4T 99-03, Scarabeo 200 200 4T 01-03
BMW C1 125 125 4T 00-03, C1 200 200 4T 02-03



cod. **RL00014**
Flangia ruota libera Aprilia Scarabeo 150/200 cc 4T

RIFERIMENTO ORIGINALE

Aprilia	AP0635150
---------	-----------

APPLICABILITÀ

Aprilia Leonardo 125 125 4T 96-02, Leonardo ST 125 4T 03-04, Scarabeo 125 125 4T 99-03, Leonardo 150 150 4T 96-02, Scarabeo 150 150 4T 99-03, Scarabeo 200 200 4T 01-03
BMW C1 125 125 4T 00-03, C1 200 200 4T 02-03



◀ **cod. RL00006**
Ruota libera Kymco Grand Dink 150 cc

RIFERIMENTO ORIGINALE

Kymco	00128934
-------	----------

APPLICABILITÀ

Kymco B&W 125 125 4T 00-00, Dink 125 125 4T 97-98, Dink Classic 125 125 4T 02-02, Dink Classic 125 125 4T 03-03, Dink LX 125 125 4T 98-00, Downtown 125 I 125 4T 09-09, Grand Dink 125 125 4T 01-02, B&W 150 150 4T 00-00, Dink 150 150 4T 97-98, Dink Classic 150 150 4T 02-02, Dink Classic 150 EU2 150 4T 03-03, Dink LX 150 150 4T 98-00, Grand Dink 150 150 4T 01-02

◀ **cod. RL00007**
Ingranaggio ruota libera Kymco Grand Dink 150 cc

RIFERIMENTO ORIGINALE

Kymco	00128929
-------	----------

APPLICABILITÀ

Kymco B&W 125 125 4T 00-00, Dink 125 125 4T 97-98, Dink Classic 125 125 4T 02-02, Dink Classic 125 125 4T 03-03, Dink LX 125 125 4T 98-00, Grand Dink 125 125 4T 01-02, B&W 150 150 4T 00-00, Dink 150 150 4T 97-98, Dink Classic 150 150 4T 02-02, Dink Classic 150 EU2 150 4T 03-03, Dink LX 150 150 4T 98-00, Grand Dink 150 150 4T 01-02



◀ **cod. RL00008**
Ruota libera Kymco Grand Dink 250 cc

RIFERIMENTO ORIGINALE

Kymco	00128935
-------	----------

APPLICABILITÀ

Kymco Dink 200 IE EU3 200 4T 06-07, Dink Classic 200 200 4T 04-04, B&W 250 250 4T 00-00, B&W 250 EU2 250 4T 03-03, Grand Dink 250 250 4T 01-02, Grand Dink 250 EU2 250 4T 03-04, KXR 250 250 4T 03-04, MXU 250 250 4T 05-05, People LC 250 250 4T 03-04, Yup 250 250 4T 03-03, MXU 300 300 4T 05-06, Maxxer 300 300 4T 05-06

◀ **cod. RL00009**
Ingranaggio ruota libera Kymco Grand Dink 250 cc

RIFERIMENTO ORIGINALE

Kymco	00128933
-------	----------

APPLICABILITÀ

Kymco B&W 250 250 4T 00-00, B&W 250 EU2 250 4T 03-03, Grand Dink 250 250 4T 01-02, Grand Dink 250 EU2 250 4T 03-04, KXR 250 250 4T 03-04, MXU 250 250 4T 05-05, People LC 250 250 4T 03-04, Yup 250 250 4T 03-03, MXU 300 300 4T 05-06, Maxxer 300 300 4T 05-06



◀ **cod. RL00010**
Ruota libera per scooter Minarelli/Yamaha 250 cc

RIFERIMENTO ORIGINALE

Yamaha	4HC155900200
Mbk	4HC155900200
Benelli	R19040171A0

Malaguti	94000600
Aprilia	AP8122626

APPLICABILITÀ

Aprilia Leonardo 250 250 4T 99-04, Leonardo 250 ST 250 4T 01-01, Leonardo 300 300 4T 02-04

Benelli Velvet 250 250 4T 99-03

Italjet Jupiter 250 250 4T 00-00

Malaguti Madison S 250 250 4T 99-01, Password 250 250 4T 05-06, Password 250 EU3 250 4T 07-08

Mbk Skyliner 250 250 4T 00-03, Skyliner 250 ABS 250 4T 03-03, Kilibre 300 300 4T 03-06

Yamaha Majesty 250 250 4T 96-03, Majesty 250 ABS 250 4T 03-03, Majesty 250 DX 250 4T 98-99, X-City 250 250 4T 07-12, X-Max 250 250 4T 05-12, Versity 300 300 4T 03-06

◀ **cod. RL00011**
Ingranaggio ruota libera Minarelli/Yamaha 250 cc

RIFERIMENTO ORIGINALE

Yamaha	1COE55170000
Benelli	R19040161A0

Malaguti	74018700
Aprilia	AP8122499

APPLICABILITÀ

Aprilia Leonardo 250 250 4T 99-04, Leonardo 250 ST 250 4T 01-01, Leonardo 300 300 4T 02-04

Benelli Velvet 250 250 4T 99-03

Italjet Jupiter 250 250 4T 00-00

Malaguti Madison S 250 250 4T 99-01, Password 250 250 4T 05-06, Password 250 EU3 250 4T 07-08

Mbk Skyliner 250 250 4T 00-03, Skyliner 250 ABS 250 4T 03-03, Kilibre 300 300 4T 03-06

Yamaha Majesty 250 250 4T 96-03, Majesty 250 ABS 250 4T 03-03, Majesty 250 DX 250 4T 98-99, X-City 250 250 4T 07-12, X-Max 250 250 4T 05-12, Versity 300 300 4T 03-06



◀ cod. **RL00012**
Ruota libera con ingranaggio Suzuki Burgman 400 cc

RIFERIMENTO ORIGINALE

Suzuki	12600-15824-000
--------	-----------------

APPLICABILITÀ

Suzuki AN Burgman 400 K3/K6 400 4T 03-06, AN Burgman 400 X/K2 400 4T 99-02



◀ cod. **RL00015**
Ruota libera Yamaha T-max 500 cc

RIFERIMENTO ORIGINALE

Yamaha	4NK155900000
--------	--------------

APPLICABILITÀ

Yamaha T-Max 485 500 500 4T 09-11, T-Max 485 ABS 500 500 4T 08-11, T-Max 5GJ 500 500 4T 01-03, T-Max 5VU 500 500 4T 04-08, T-Max 5VU ABS 500 500 4T 05-07, T-Max 5VU BLACK MAX 500 4T 06-06, T-Max 5VU BLACK MAX - NIGHT MAX 500 4T 07-07, T-Max 59C 530 530 4T 12-16, T-Max 59C 530 ABS 530 4T 12-16, T-Max 59C 530 SP 530 4T 15-15, T-Max 59C 530 SP ABS 530 4T 15-16

◀ cod. **RL00016**
Ingranaggio ruota libera Yamaha T-max 500 cc

RIFERIMENTO ORIGINALE

Yamaha	5GJ155170000
--------	--------------

APPLICABILITÀ

Yamaha T-Max 485 500 500 4T 09-11, T-Max 485 ABS 500 500 4T 08-11, T-Max 5GJ 500 500 4T 01-03, T-Max 5VU 500 500 4T 04-08, T-Max 5VU ABS 500 500 4T 05-07, T-Max 5VU BLACK MAX 500 4T 06-06, T-Max 5VU BLACK MAX - NIGHT MAX 500 4T 07-07, T-Max 59C 530 530 4T 12-16, T-Max 59C 530 ABS 530 4T 12-16, T-Max 59C 530 SP 530 4T 15-15, T-Max 59C 530 SP ABS 530 4T 15-16



◀ cod. **RL00017**
Ruota libera con Ingranaggio Suzuki Burgman 125/150

RIFERIMENTO ORIGINALE

Suzuki	12600-21822-000
--------	-----------------

APPLICABILITÀ

Suzuki Epicuro 125 125 4T 99-01, UH Burgman 125 K2/K6 125 4T 02-06, Epicuro 150 150 4T 99-01, UH Burgman 150 K2/K6 150 4T 02-06



◀ cod. **RL00018**
Ruota libera con Ingranaggio Suzuki Burgman 250 cc

RIFERIMENTO ORIGINALE

Suzuki	12600-14810-000
--------	-----------------

APPLICABILITÀ

Suzuki AN Burgman 250 K3/K6 250 4T 03-06, AN Burgman 250 W/K2 250 4T 98-02



◀ cod. **RL00019**
Ruota libera Yamaha Majesty 400 cc

RIFERIMENTO ORIGINALE

Yamaha	5RU155900000
--------	--------------

APPLICABILITÀ

Yamaha Majesty 400 400 4T 04-11, Majesty 400 ABS 400 4T 07-11, X-MAX 400 4T-4V 15-16, X-MAX ABS 400 4T-4V 14-16, X-MAX IRONMAX ABS 400 4T-4V 16-16, X-MAX MOMODESIGN 400 4T-4V 14-14, X-MAX MOMODESIGN ABS 400 4T-4V 14-14

◀ cod. **RL00020**
Ingranaggio ruota libera Yamaha Majesty 400 cc

RIFERIMENTO ORIGINALE

Yamaha	5RU155170000
--------	--------------

APPLICABILITÀ

Yamaha Majesty 400 400 4T 04-11, Majesty 400 ABS 400 4T 07-11, X-MAX 400 4T-4V 15-16, X-MAX ABS 400 4T-4V 14-16, X-MAX IRONMAX ABS 400 4T-4V 16-16, X-MAX MOMODESIGN 400 4T-4V 14-14, X-MAX MOMODESIGN ABS 400 4T-4V 14-14



◀ **cod. RL00021**
Ruota libera Piaggio 500 cc

RIFERIMENTO ORIGINALE

Piaggio	8494905
Aprilia	8494905
Gilera	8494905

Derbi	8494905
Malaguti	44003600
Peugeot	759737

APPLICABILITÀ

Aprilia Atlantic Arrecife 200 200 4T -00, Atlantic 250 EU3 250 4T 06-08, Atlantic Arrecife 250 250 4T -00, Atlantic 300 300 4T 10-11, SR MAX 300 300 4T 11-14, Scarabeo Light 300 300 4T 09-10, Sportcity Cube 300 300 4T 08-10, Sport City Street 300 300 4T-4V 12-12, Atlantic Arrecife 400 400 4T -00, Atlantic Sprint 400 400 4T 05-08, Scarabeo Light 400 400 4T 06-08, Atlantic 500 500 4T 01-04, Atlantic Arrecife 500 500 4T 05-08, Atlantic Sprint 500 500 4T 05-08, Scarabeo 500 500 4T 03-06, Scarabeo Light 500 500 4T 06-08

Derbi GP1 250 250 4T 06-07, Rambla 300 300 4T 10-11

Gilera Nexus 300 EU3 300 4T 08-11, Fuoco 500 IE EU3 500 4T 07-13, Nexus 500 500 4T 03-05, Nexus 500 IE EU3 500 4T 06-11, Nexus SP 500 EU3 500 4T 06-07

Malaguti Madison RS 250 250 4T 04-04, Phantom Max 250 250 4T 04-04, Spider Max 500 GT 500 4T 04-05, Spider Max 500 GT EU3 500 4T 06-06, Spider Max RS 500 500 4T 08-08

Peugeot Geopolis 400 IE EU3 400 4T-4V -00, Satelis 400 EU3 400 4T -00, Geopolis 500 IE EU3 500 4T-4V -00, Satelis 500 EU3 500 4T -00

Piaggio Beverly 125 RST 4T 4V IE EU3 125 4T 10-15, Beverly RST 250 250 4T 04-05, Vespa GTS 250 250 4T 05-16, Vespa GTS ABS 250 250 4T 05-12, X9 Evolution 250 250 4T 04-04, X9 Evolution 250 250 4T 06-06, Beverly 300 RST 4T 4V IE EU3 300 4T 10-15, Beverly Tourer 300 EU3 300 4T 09-10, Carnaby Cruiser 300 300 4T 09-12, MP3 300 4T 4V IE LT Ibrido 300 4T 10-11, MP3 300 IE LT 300 4T 10-11, MP3 300 IE LT Touring 300 4T 11-13, MP3 300 IE LT/Sport 300 4T 11-14, MP3 300 IE MIC 300 4T 10-11, MP3 300 IE Touring 300 4T 11-12, Vespa GTS IE Touring 300 300 4T 11-12, Vespa GTS Super 300 4T 08-15, Vespa GTS Super Sport 300 4T 10-13, Vespa GTV 4T 4V IE 300 300 4T 10-13, Vespa GTV VIA MONTENAPOLEONE 300 4T 10-10, X7 Evo 300 IE EU3 300 4T 09-10, Beverly 350 4T 4V IE EU3 350 4T 11-13, Beverly 400 EU3 400 4T 06-07, Beverly Tourer 400 EU3 400 4T 08-10, MP3 400 400 4T 07-08, MP3 400 IE LT Touring 400 4T 11-11, MP3 400 IE LT/Sport 400 4T 08-10, MP3 400 MIC 400 4T 08-10, MP3 400 RL Touring 400 4T 11-11, X-Evo 400 400 4T 07-11, X8 400 EU3 400 4T 06-08, Beverly 500 500 4T 02-06, Beverly 500 IE EU3 500 4T 06-08, Beverly Cruiser 500 500 4T 07-11, MP3 500 LT Sport/Business 500 4T -, MP3 500 RL Sport 500 4T -, X9 500 500 4T 01-02, X9 Evolution 500 500 4T 03-07



◀ **cod. RL00023**
Ingranaggio ruota libera Piaggio 500 cc

RIFERIMENTO ORIGINALE

Piaggio	82737R
Malaguti	44001900
Peugeot	758789

Aprilia	82737R
Gilera	82737R
Derbi	82737R

APPLICABILITÀ

Aprilia SR MAX 125 125 4T 11-14, Atlantic 250 250 4T 03-05, Atlantic 250 EU3 250 4T 06-08, Scarabeo 250 250 4T 04-06, Scarabeo Light 250 250 4T 06-08, Sportcity 250 EU3 250 4T 06-08, Sportcity Cube 250 250 4T 08-12, Atlantic 300 300 4T 10-11, SR MAX 300 300 4T 11-14, Scarabeo Light 300 300 4T 09-10, Sportcity Cube 300 300 4T 08-10, Sport City Street 300 300 4T-4V 12-12, Atlantic Arrecife 400 400 4T -00, Atlantic Sprint 400 400 4T 05-08, Scarabeo Light 400 400 4T 06-08, Atlantic 500 500 4T 01-04, Atlantic Arrecife 500 500 4T 05-08, Atlantic Sprint 500 500 4T 05-08, Scarabeo 500 500 4T 03-06, Scarabeo Light 500 500 4T 06-08

Derbi GP1 250 250 4T 06-07, GP1 250 Low Seat EU3 250 4T 07-08, Rambla 250 EU3 2VER 250 4T 08-08, Rambla 300 300 4T 10-11

Gilera Nexus 125 IE EU3 125 4T 08-10, Nexus 250 EU3 250 4T 06-07, Nexus SP 250 EU3 250 4T 06-07, Nexus 300 EU3 300 4T 08-11, Fuoco 500 IE EU3 500 4T 07-13, Nexus 500 500 4T 03-05, Nexus 500 EU3 500 4T 06-11, Nexus SP 500 EU3 500 4T 06-07

Malaguti Madison 3 250 250 4T 06-09, Madison RS 250 250 4T 04-04, Phantom Max 250 250 4T 04-04, Spider Max 500 GT 500 4T 04-05, Spider Max 500 GT EU3 500 4T 06-06, Spider Max RS 500 500 4T 08-08

Peugeot Geopolis 400 IE EU3 400 4T-4V -00, Satelis 400 EU3 400 4T -00, Geopolis 500 IE EU3 500 4T-4V -00, Satelis 500 EU3 500 4T -00

Piaggio MP3 125 IE 125 4T 08-09, MP3 125 IE Touring 125 4T 11-12, MP3 125 Ibrido 125 4T 09-10, MP3 125 Yourban ERL 125 4T 11-11, Vespa GTS 4T IE SUPER 125 4T 09-16, X7 Evo 125 IE EU3 125 4T 09-10, Beverly 250 250 4T 06-07, Beverly 250 CRUISER 250 4T 07-09, Beverly 250 EURO 3 MIC 250 4T 07-07, Beverly 250 SPORT 250 4T 06-08, Beverly 250 Tourer EU3 250 4T 07-09, Beverly 250 IE EU3 250 4T 06-08, Beverly RST 250 250 4T 04-05, Carnaby 250 250 4T 08-08, MP3 250 250 4T 06-08, MP3 250 LT 250 4T 08-09, MP3 250 MIC 250 4T 08-09, Vespa GT 60 250 EU3 250 4T 06-07, Vespa GTS 250 250 4T 05-16, Vespa GTS ABS 250 250 4T 05-12, Vespa GTV 250 250 4T 06-09, Vespa GTV 4T NAVY EU3 250 250 4T 07-07, X-Evo 250 250 4T 07-16, X7 250 EU3 250 4T 08-08, X8 250 EU3 250 4T 05-08, X9 Evolution 250 250 4T 04-04, X9 Evolution 250 250 4T 06-06, Beverly 300 RST 4T 4V IE EU3 300 4T 10-15, Beverly Tourer 300 EU3 300 4T 09-10, MP3 300 4T 4V IE LT Ibrido 300 4T 10-11, MP3 300 IE LT 300 4T 10-11, MP3 300 IE LT Touring 300 4T 11-13, MP3 300 IE LT/Sport 300 4T 11-14, MP3 300 IE MIC 300 4T 10-11, MP3 300 IE Touring 300 4T 11-12, MP3 300 Yourban ERL 300 4T 11-15, MP3 300 Yourban LT ERL 300 4T 11-12, Vespa GTS IE Touring 300 300 4T 11-12, Vespa GTS Super 300 4T 08-15, Vespa GTS Super Sport 300 4T 10-13, Vespa GTV 4T 4V IE 300 300 4T 10-13, Vespa GTV VIA MONTENAPOLEONE 300 4T 10-10, X7 Evo 300 IE EU3 300 4T 09-10, Beverly 350 4T 4V IE EU3 350 4T 11-13, Beverly 400 EU3 400 4T 06-07, Beverly Tourer 400 EU3 400 4T 08-10, MP3 400 400 4T 07-08, MP3 400 IE LT Touring 400 4T 11-11, MP3 400 IE LT/Sport 400 4T 08-10, MP3 400 MIC 400 4T 08-10, MP3 400 RL Touring 400 4T 11-11, X-Evo 400 400 4T 07-11, X8 400 EU3 400 4T 06-08, Beverly 500 500 4T 02-06, Beverly 500 IE EU3 500 4T 06-08, Beverly Cruiser 500 500 4T 07-11, MP3 500 LT Sport/Business 500 4T -, MP3 500 RL Sport 500 4T -, X9 500 500 4T 01-02, X9 Evolution ABS 500 500 4T 06-07



◀ cod. **RL00024**
Ingranaggio ruota libera Kymco Agility 125 cc

RIFERIMENTO ORIGINALE

Kymco	001228728
-------	-----------

Malaguti	54001200
----------	----------

APPLICABILITÀ

Kymco Agility 125 125 4T 06-06, Agility 125 EU3 125 4T 06-08, Heroism 125 125 4T 95-97, Movie 125 EU3 125 4T 06-07, People 125 125 4T 99-00, People 125 EU3 125 4T 07-08, People S 125 125 4T 05-05, Super 8 125 125 4T 08-09, Vivio 125 125 4T 00-00, Heroism 150 150 4T 95-97, Movie 150 EU3 150 4T 06-07, People 150 150 4T 99-00, Vivio 150 150 4T 00-00, People S 200 200 4T 05-05

Malaguti Ciak Master 125 125 4T 04-04, Ciak Master 150 150 4T 04-04, Ciak Master 200 EU2 200 4T 06-06



◀ cod. **RL00025**
Ruota libera Kymco Agility 125 cc

RIFERIMENTO ORIGINALE

Kymco	00128742
-------	----------

Malaguti	54001900
----------	----------

APPLICABILITÀ

Kymco Agility 125 125 4T 06-06, Agility 125 EU3 125 4T 06-08, Movie 125 EU3 125 4T 06-07, People 125 125 4T 99-00, People 125 EU3 125 4T 07-08, People S 125 125 4T 05-05, Super 8 125 125 4T 08-09, Vivio 125 125 4T 00-00, Movie 150 EU3 150 4T 06-07, People 150 150 4T 99-00, Vivio 150 150 4T 00-00, People S 200 200 4T 05-05

Malaguti Ciak Master 125 125 4T 04-04, Ciak Master 150 150 4T 04-04, Ciak Master 200 EU2 200 4T 06-06



◀ cod. **RL00026**
Ingranaggio ruota libera Kymco Xciting 500 cc

RIFERIMENTO ORIGINALE

Kymco	00128059
-------	----------

APPLICABILITÀ

Kymco Xciting 500 500 4T 05-05, Xciting 500I 500 4T 06-08, Xciting R 500 500 4T 09-09, Xciting R 500I 500 4T 07-08



◀ cod. **RL00027**
Ruota libera Kymco Xciting 500 cc

RIFERIMENTO ORIGINALE

Kymco	00128060
-------	----------

APPLICABILITÀ

Kymco Xciting 500 500 4T 05-05, Xciting 500I 500 4T 06-08, Xciting R 500 500 4T 09-09, Xciting R 500I 500 4T 07-08



◀ cod. **RL00028**
Ruota libera Kymco Xciting 250 cc

RIFERIMENTO ORIGINALE

Kymco	00126013
-------	----------

APPLICABILITÀ

Kymco Downtown I 200 200 4T 10-10, People GTI 200 200 4T 10-10, People S 250 250 4T 06-06, People S 250 I 250 4T 07-07, Xciting 250 250 4T 05-05, Xciting 250 I 250 4T 06-07, Downtown 300I 300 4T 09-09, Downtown ABS 300 300 4T 10-10, Downtown I 300 300 4T 11-11, Downtown I ABS 300 300 4T 11-11, MXU R 300 300 4T 10-10, People GTI 300 300 4T 10-11, People S 300 I 300 4T 08-08, Xciting 300 I 300 4T 08-08, Xciting R 300i 300 4T 08-09



◀ cod. **RL00031**
Ingranaggio ruota libera Kymco Xciting 250 cc

RIFERIMENTO ORIGINALE

Kymco	00126012
-------	----------

APPLICABILITÀ

Kymco People S 250 250 4T 06-06, People S 250 I 250 4T 07-07, Xciting 250 250 4T 05-05, Xciting 250 I 250 4T 06-07, MXU R 300 300 4T 10-10, People S 300 I 300 4T 08-08, Xciting 300 I 300 4T 08-08, Xciting R 300i 300 4T 08-09



◀ cod. **RL00029**
Ingranaggio ruota libera Honda SH 300 cc

RIFERIMENTO ORIGINALE

Honda	28110KTW900
-------	-------------

APPLICABILITÀ

Honda Forza 250 [NSS A] 250 4T-4V 08-11, Forza 250 [NSS S] 250 4T-4V 08-11, SH IE 300 Scoopy 300 4T-4V 07-16



◀ cod. **RL00030**
Ruota libera Honda SH 300 cc

RIFERIMENTO ORIGINALE

Honda	28125HN5671
-------	-------------

APPLICABILITÀ

Honda Forza 250 [NSS A] 250 4T-4V 08-11, Forza 250 [NSS S] 250 4T-4V 08-11, Forza EX 250 [NSS] 250 4T-2V 05-07, Forza X 250 [NSS] 250 4T-2V 05-07, SH IE 300 Scoopy 300 4T-4V 07-16

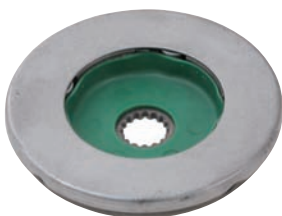

◀ cod. **RL00032**
Ruota libera completa Yamaha Majesty 125/180 cc (YP) dal '03

RIFERIMENTO ORIGINALE

Yamaha	5XME55700000	Mbk	5XME55700000
--------	--------------	-----	--------------

APPLICABILITÀ

Mbk Skyliner E 125 125 4T 03-03, Skyliner E 180 180 4T 03-03 **Yamaha** Majesty 125 E 125 4T 03-09, Majesty 180 E 180 4T 03-06



◀ cod. **RL00033**
Ruota libera Kymco Agility 50 cc

RIFERIMENTO ORIGINALE

Kymco	00107245
-------	----------

APPLICABILITÀ

Kymco Agility 4T Carry 50 4T 11-11, Agility 4T R10 50 4T 06-08, Agility 4T R12 50 4T 07-08, Agility R12 50 4T 05-05, Agility R16 50 4T 08-09, Agility R16 50 4T 12-12, Agility R16 2T 50 2T 10-10, Agility R16 2T 50 2T 12-12, Agility RS 50 4T 09-09, Agility RS Naked 50 2T 10-10, Bet & Win 50 2T 02-02, Bet & Win EU2 50 2T 03-03, Dink AC 50 2T 98-02, Dink LC 50 2T 98-02, Dink Classic EU2 50 2T 03-03, Dink Euro 2 50 4T 07-07, Filly 50 4T 98-00, Filly LX 50 4T 01-02, Heroism 50 2T 95-97, Like 50 2T 09-09, Like 50 4T 09-09, People 50 2T 99-04, People Euro 2 50 2T 03-03, People Euro 2 50 2T 08-08, People Euro 2 50 2T 11-11, People S 50 2T 05-08, People S 4T 50 4T 06-08, Sento 50 4T 08-08, Sniper 50 2T 93-93, Sniper DD 50 2T 94-96, Super 8 50 2T 09-09, Super 8 4T 50 4T 07-07, Super 8 4T 50 4T 09-09, Super 9 50 2T 00-00, Super 9 EU2 50 2T 03-04, Top Boy 50 2T 97-00, Vitality 2T 50 2T 04-04, Vitality 4T 50 4T 04-04, Yup 50 2T 02-02, Yup EU2 50 2T 03-03



◀ cod. **RL00034**
Ruota libera Yamaha X-Max 125 cc

RIFERIMENTO ORIGINALE

Yamaha	1B9E55800000	Mbk	1B9E55800000
--------	--------------	-----	--------------

APPLICABILITÀ

Mbk Cityliner 125 EU3 125 4T-4V 08-10, Skycruiser 125 125 4T-4V 07-07 **Yamaha** X-City 125 EU3 125 4T-4V 08-11, X-Max R 125 125 4T-4V 06-16, X-Max R 125 ABS 125 4T-4V 11-11, X-Max RA 125 ABS 125 4T-4V 13-16



◀ cod. **RL00035**
Ingranaggio ruota libera Yamaha X-Max 125 cc

RIFERIMENTO ORIGINALE

Yamaha	5YPE55240000	Mbk	5YPE55240000
--------	--------------	-----	--------------

APPLICABILITÀ

Mbk Cityliner 125 EU3 125 4T-4V 08-10, Skycruiser 125 125 4T-4V 07-07 **Yamaha** X-City 125 EU3 125 4T-4V 08-11, X-Max R 125 125 4T-4V 06-16, X-Max R 125 ABS 125 4T-4V 11-11, X-Max RA 125 ABS 125 4T-4V 13-16

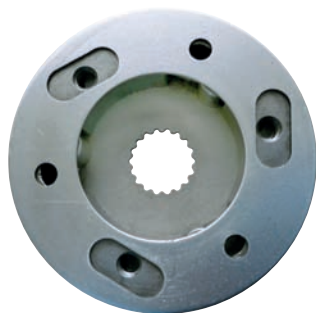

◀ **cod. RL00038**
Ruota libera Yamaha Xenter 125 cc con flangia

RIFERIMENTO ORIGINALE

Yamaha	52SE55700000
--------	--------------

APPLICABILITÀ

Yamaha Xenter 125 125 4T 12-16, Xenter 150 150 4T 12-16



◀ **cod. RL00022**
Ruota Libera Piaggio Liberty 125cc

APPLICABILITÀ

Aprilia Atlantic 125 125 4T 03-05, Atlantic 125 EU3 125 4T 06-08, Atlantic 125 EU3 125 4T 10-12, Mojito 125 125 4T 03-08, SR Motard 125 125 4T 2V 12-12, Scarabeo 125 125 4T 03-06, Scarabeo EU3 125 125 4T 06-07, Sport City Street 125 125 4T 12-12, Sportcity 125 125 4T 04-06, Sportcity 125 EU3 125 4T 06-08, Sportcity Cube 125 125 4T 08-10, Sportcity Cube 200 125 4T 08-10, Sportcity One 4T EU3 125 125 4T 08-11, Mojito 150 150 4T 03-07, Scarabeo 150 150 4T 99-06, Atlantic 200 200 4T 03-05, Scarabeo 200 200 4T 03-03, Scarabeo EU3 200 200 4T 06-07, Sportcity 200 200 4T 04-06, Sportcity 200 EU3 200 4T 06-08

Derbi Boulevard 125 125 4T 02-04, Boulevard 125 EU3 125 4T 04-07, Boulevard 4T EU3 125 4T 08-12, GP1 125 EU 2 125 4T 06-06, GP1 Low Seat EU3 125 4T 07-08, Rambla 125 125 4T 08-09, Rambla 125 EU3 2VER 125 4T 08-08, Sonar 4T 125 125 4T 09-11, Variant Sport 4T EU3 125 4T 12-12, Boulevard 150 150 4T 02-04, Boulevard 150 EU3 150 4T 04-07, Boulevard 4T E3 150 4T 10-10, Sonar 4T 150 150 4T 09-09, Boulevard 200 200 4T

Gilera DNA 125 125 4T 01-01, Nexus 125 EU3 125 4T 07-08, Runner 4T ST EU3 125 125 4T -, Runner VX 125 125 4T 00-06, Runner VX 4T EU3 125 125 4T 06-07, Runner VX Race 125 125 4T 06-06, Runner VX SC 125 4T 06-07, Runner VXR Race 200 125 4T 06-06, DNA 180 180 4T 01-01, Runner VXR 180 180 4T 00-01, Runner VXR 200 200 4T 02-06, Runner VXR 4T ST EU3 200 200 4T 08-11, Runner VXR EU3 200 200 4T 07-07

Piaggio Beverly 125 125 4T 01-03, Beverly 125 EU3 125 4T 07-08, Beverly 125 EURO 3 MIC 125 4T 07-07, Beverly 125 EURO 3 SPORT 125 4T 07-08, Beverly 125 Tourer EU3 125 4T -, Beverly RST 125 125 4T 04-, Carnaby 125 125 4T 07-10, Fly 125 125 4T 05-07, Fly 125 EU3 125 4T 07-11, Hexagon GTX 125 125 4T 00-00, Liberty 125 125 4T 98-02, Liberty 125 4T 125 4T 06-07, Liberty 125 4T EU3 125 4T 07-08, Liberty 125 4T EU3 Delivery -TNT 125 4T -, Liberty 125 4T Sport EU3 125 4T 06-08, Liberty 125 Sport 125 4T 06-06, Liberty 4T 2V Euro3 125 4T -, Liberty RST 125 125 4T 04-05, Liberty RST PTT 125 125 4T 05-11, MP3 125 125 4T 06-08, Skyyper 125 4T 125 4T 00-02, Super Hexagon GTX 12 125 125 4T 01-02, Typhoon 125 4T 2V E3 125 4T 10-11, Vespa ET4 125 125 4T 96-02, Vespa GRANTURISMO 125 125 4T 03-07, Vespa GRANTURISMO 125 EU3 125 4T 06-07, Vespa GTS 125 EU3 125 4T 07-12, Vespa GTV 125 125 4T -, Vespa GTV 4T NAVY EU3 125 125 4T 08-08, Vespa LX 125 125 4T 05-06, Vespa LX 4T EU3 TOURING 125 4T 10-11, Vespa LX 4T FL 125 4T 09-09, Vespa LX EU3 125 4T 06-08, Vespa LX EU3 IE 125 4T 09-10, Vespa LXV 4T EU3 125 4T 06-09, Vespa LXV IE 4T 125 4T 10-12, Vespa LXV NAVY EU3 125 4T -, Vespa S 4T 125 EU3 125 4T 07-08, Vespa S 4T IE & COLLEGE 125 4T 09-11, X-Evo 125 125 4T 07-12, X7 125 EU3 125 4T 08-08, X8 125 125 4T 04-06, X8 125 Premium EU2 125 4T 06-06, X8 125 Premium EU3 125 4T 06-07, X8 Street 125 EU2 125 4T 06-07, X9 125 125 4T 01-02, X9 Evolution 125 125 4T 03-03, X9 Evolution 125 125 4T 05-06, X9 Evolution EU3 125 125 4T 07-07, Zip 125 125 4T 00-02, Fly 150 150 4T 05-07, Fly 150 EU3 150 4T 08-11, Liberty 150 150 4T 01-02, Liberty 150 4T EU3 150 4T 08-08, Liberty 150 4T Sport EU3 150 4T 08-08, Liberty 150 Moc 4T 150 4T 09-13, Skyyper 150 4T 150 4T 00-02, Vespa ET4 150 150 4T 99-02, Vespa LX 150 150 4T 05-06, Vespa LX 4T FL 150 4T 09-09, Vespa LX EU3 150 4T 06-08, Vespa LX EU3 IE 150 4T 09-11, Vespa LX TOURING 150 4T -, Vespa S 4T 150 150 4T 08-09, Vespa S 4T IE & COLLEGE 150 4T 09-11, X8 Street 150 EU2 150 4T 06-08, Hexagon GTX 180 180 4T 00-00, Super Hexagon GTX 12 180 180 4T 01-02, X9 Amalfi 180 180 4T 00-03, Beverly 200 200 4T 01-03, Carnaby 200 200 4T 07-08, Liberty 200 200 4T 06-06, Liberty 200 4T EU3 200 4T -, Liberty 200 4T Sport EU3 200 4T 06-07, Liberty 200 Sport 200 4T 06-06, Liberty RST 200 200 4T 04-04, Vespa GRANTURISMO 200 200 4T 03-07, X8 200 200 4T 04-07, X9 200 200 4T 02-03, X9 Evolution 200 200 4T 03-03

RIFERIMENTO ORIGINALE

Piaggio	82612R
---------	--------



◀ **cod. RL00039**
Ruota Libera Piaggio Liberty 50cc 4T

APPLICABILITÀ

- Aprilia** RS 50 50 2T 06-10, RS4 50 2T 11-13, SR R 50 2T 04-09, SR R FACTORY IE 50 2T -, Scarabeo 4T 50 4T 02-06, Scarabeo 4T 4V 50 4T 04-10, Scarabeo 4T 4V NET 50 4T 09-10, Scarabeo 4T Restyling EU3 50 4T 06-09, Scarabeo Quattro 50 4T 09-09, Sport City One 4T 50 4T 08-10
- Derbi** Atlantis 4T 50 4T 04-06, Atlantis 4T EU2 50 4T 07-07, Boulevard 4T EU2 25KM/H 50 4T -, GPR 2T EU2 50 2T 09-10, GPR NUDE & GPR NUDE Tuning 50 2T 06-08, GPR NUDE Sport 50 2T 06-06, GPR Racing EU2 50 2T 06-06, GPR Replica & GPR R EU2 50 2T 06-06, GPR Replica 2T Malossi 50 2T 07-07, GPR Replica Pesek EU2 50 2T 07-07, Senda R DRD PRO EU2 50 2T 05-11, Senda SM DRD PRO EU2 50 2T 05-11
- Gilera** Runner Pure Jet 50 2T-IE 02-07, Runner Pure Jet 50 2T-IE 10-11
- Malaguti** Centro Euro 2 50 4T 08-08, Centro SL 4T 50 4T 10-10, Ciak Master 4T 50 4T 05-06
- Piaggio** Fly 4T 50 4T 05-07, Fly 4T & 25-30 KM/H 50 4T -, Fly 4T Motore CHN 50 4T 06-07, Liberty 4T 50 4T 00-02, Liberty 4T 50 4T 05-08, Liberty 4T Delivery - Single 50 4T 10-12, Liberty 4T Delivery TNT 50 4T 09-09, Liberty 4T PTT - DOUBLE 50 4T 09-12, Liberty 4T RST 50 4T 04-04, Liberty 4T Sport 50 4T 06-08, Liberty MOC 2T & Elle 50 2T -, NRG Power Pure Jet 50 2T-IE 04-05, NRG Power PureJet 50 2T-IE 06-11, NRG PureJet 50 2T-IE 02-04, NRG PureJet 50 2T-IE 10-10, Vespa ET4 50 4T 00-05, Vespa LX 4T 50 4T 05-08, Vespa LX 4T 4V 50 4T 09-11, Vespa LX 4T 4V Touring 50 4T 09-11, Vespa LX 4T 4V & College 50 4T 08-11, Zip 4T 50 4T 00-13, Zip RST 50 2T 96-99

RIFERIMENTO ORIGINALE

Piaggio	289202
---------	--------



◀ **cod. RL00040**
Ruota Libera Piaggio Liberty 50cc 2T

APPLICABILITÀ

- Aprilia** SR R FACTORY Carburatore 50 2T -, SR Stealth 50 2T 97-99, SR Street Carburatore 50 2T 03-12, Scarabeo 2T EU2 Motore Piaggio 50 2T 10-12, Scarabeo 2T Net 50 2T 09-10, Scarabeo Street 50 2T 05-06, Scarabeo Street 2T Restyling 50 2T 06-09, Sport City One 2T 50 2T 08-11
- Derbi** Atlantis 2T 50 2T 10-10, Atlantis 2T EU2 50 2T 07-09, Atlantis O2 50 2T 02-02, Atlantis O2 Bullet 50 2T 03-05, Atlantis O2 City 50 2T 03-06, Atlantis O2 Red Bullet 50 2T 03-03, Atlantis O2 Two Chic 50 2T 05-05, Boulevard 50 2T 09-12, GP1 50 2T 01-03, GP1 EU2 50 2T 05-05, GP1 Open EU2 50 2T 06-09, GP1 Race EU2 50 2T 05-07, Sonar 2T 50 2T 09-09
- Gilera** DNA 50 2T 00-02, DNA 50 2T 05-07, DNA GP Experience 50 2T 03-04, Easy Moving 50 2T 95-96, Ice 50 2T 01-05, Runner 50 2T 97-00, Runner Poggiali 50 2T 02-02, Runner SP 50 2T 02-07, Runner SP 50 2T 10-12, Runner SP ST & Simoncelli 50 2T 08-09, Runner SP Special Edition 50 2T 07-07, Stalker 50 2T 97-11, Stalker Naked 50 2T 08-08, Stalker Special Edition 50 2T 07-08, Storm 50 2T 94-95, Storm Euro 2 50 2T 07-07, Typhoon 50 2T 94-97, Typhoon X 50 2T 98-99, Typhoon XR 50 2T 00-00
- Piaggio** Diesis 50 2T 01-01, Fly 2T 50 2T 05-07, Fly 2T 50 2T 10-11, Free 50 2T 92-94, Free Delivery 50 2T 00-01, Free FL 50 2T 95-02, Liberty 50 2T 97-05, Liberty 2T 50 2T 06-08, Liberty 2T PTT EU2 50 2T 04-05, Liberty 2T RST 50 2T 04-04, Liberty 2T Sport 50 2T 06-08, NRG 50 2T 94-96, NRG Extreme 50 2T 99-00, NRG MC3 50 2T 01-04, NRG Power DD 50 2T 05-13, NRG Power DD Serie Speciale 50 2T -, NRG Power DT 50 2T 06-11, NRG Power DT Serie Speciale 50 2T 07-08, NRG RST MC2 50 2T 96-98, NTT 50 2T 95-96, Quartz 50 2T 92-96, Sfera 50 2T 91-93, Sfera Maquillage 2 50 2T 94-94, Sfera RST 50 2T 95-97, Typhoon 50 2T 01-11, Typhoon 2T E2 50 2T 10-12, Typhoon 2T E3 CH 50 2T 11-11, Vespa ET2 50 2T 97-05, Vespa ET2 iniezione 50 2T 97-00, Vespa LX 2T 50 2T 05-08, Vespa LX 2T Touring 50 2T 10-11, Vespa LXV 2T 50 2T -, Vespa LXV 2T NAVY 50 2T 08-08, Vespa S 2T & College 50 2T 07-12, Zip 50 2T 92-93, Zip 50 2T 95-96, Zip 2T 50 2T -, Zip Bimodale 50 2T 94-97, Zip Fast Rider 50 2T 93-94, Zip Fast Rider RST 50 2T 96-97, Zip LC 50 2T 00-04, Zip Sp 50 2T 96-04, Zip Sp Euro 2 50 2T

RIFERIMENTO ORIGINALE

Piaggio	286174
---------	--------



◀ **cod. RL00041**
Ruota Libera Piaggio Beverly 125/250cc

APPLICABILITÀ

- Aprilia** Atlantic 125 EU3 125 4T 06-08, SR MAX 125 125 4T 11-14, Sportcity 125 EU3 125 4T 06-08, Atlantic 250 EU3 250 4T 06-08, Scarabeo Light 250 250 4T 06-08, Sportcity Cube 250 250 4T 08-12
- Derbi** Rambla 125 125 4T 08-09, Rambla 125 EU3 2VER 125 4T 08-08, GP1 250 Low Seat EU3 250 4T 07-08, Rambla 250 250 4T 08-09, Rambla 250 EU3 2VER 250 4T 08-08
- Gilera** Nexus 125 IE EU3 125 4T 08-10, Nexus 250 EU3 250 4T 06-07, Nexus SP 250 EU3 250 4T 06-07
- Piaggio** Beverly 125 RST 4T 4V IE EU3 125 4T 10-15, MP3 125 IE 125 4T 08-09, MP3 125 IE Touring 125 4T 11-12, MP3 125 Ibrido 125 4T 09-10, Vespa GTS 4T IE SUPER 125 4T 09-16, X7 Evo 125 IE EU3 125 4T 09-10, Beverly 250 CRUISER 250 4T 07-09, Beverly 250 EURO 3 MIC 250 4T 07-07, Beverly 250 SPORT 250 4T 06-08, Beverly 250 Tourer EU3 250 4T 07-09, Beverly 250 ie EU3 250 4T 06-08, Carnaby 250 250 4T 08-08, MP3 250 250 4T 06-08, MP3 250 LT 250 4T 08-09, MP3 250 MIC 250 4T 08-09, Vespa GT 60 250 EU3 250 4T 06-07, Vespa GTS 250 250 4T 05-16, Vespa GTS ABS 250 250 4T 05-12, Vespa GTV 250 250 4T 06-09, Vespa GTV 4T NAVY EU3 250 250 4T 07-07, X-Evo 250 250 4T 07-16, X7 250 EU3 250 4T 08-08, X8 250 EU3 250 4T 05-08

RIFERIMENTO ORIGINALE

Piaggio	8477975T
---------	----------

MAXI SCOOTER



◀ cod. **SG15709**
Serie segmenti tipo originale per Kymco 125 cc

RIFERIMENTO ORIGINALE

Kymco	00123728
-------	----------

APPLICABILITÀ

Kymco Agility 125 R16 125 4T 08-09, B&W 125 125 4T 00-00, Dink 125 125 4T 97-98, Dink Classic 125 125 4T 02-02, Dink Classic 125 EU2 125 4T 03-03, Dink LX 125 125 4T 98-00, Grand Dink 125 125 4T 01-02, Heroism 125 125 4T 95-97, Like 125 125 4T 09-09, Movie 125 125 4T 99-00, Movie 125 EU3 125 4T 06-07, Movie XL 125 125 4T 01-01, People 125 125 4T 99-00, People 125 EU3 125 4T 07-08, Super 8 125 125 4T 08-09, Vivio 125 125 4T 00-00

◀ cod. **SG15710**
Serie segmenti tipo originale per Kymco 150 cc

RIFERIMENTO ORIGINALE

Kymco	00123740
-------	----------

APPLICABILITÀ

Kymco Agility 150 R16 150 4T 08-09, B&W 150 150 4T 00-00, Dink 150 150 4T 97-98, Dink Classic 150 150 4T 02-02, Dink Classic 150 EU2 150 4T 03-03, Dink LX 150 150 4T 98-00, Grand Dink 150 150 4T 01-02, Heroism 150 150 4T 95-97, Movie 150 EU3 150 4T 06-07, People 150 150 4T 99-00, Vivio 150 150 4T 00-00

◀ cod. **SG15711**
Serie segmenti tipo originale per Honda Pantheon 150

APPLICABILITÀ

Honda Pantheon 150 [FES] 150 2T 98-02

◀ cod. **SG15712**
Serie segmenti tipo originale per Suzuki Burgman 400

RIFERIMENTO ORIGINALE

Suzuki	12140-15F00-000
--------	-----------------

APPLICABILITÀ

Suzuki AN Burgman 400 K3/K6 400 4T 03-06, AN Burgman 400 X/K2 400 4T 99-02



◀ cod. **FA10100**
Filtro Aria Kymco Dink 125/150cc 02-07

APPLICABILITÀ

Kymco Dink Classic 125 125 4T 02-02, Dink Classic 125 EU2 125 4T 03-03, Dink LX 125 125 4T 98-00, Dink Classic 150 150 4T 02-02, Dink Classic 150 EU2 150 4T 03-03, Dink LX 150 150 4T 98-00, Dink Classic 200 200 4T 04-04

RIFERIMENTO ORIGINALE

Kymco	162993
-------	--------

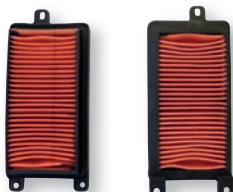

◀ cod. **FA10101**
Filtro Aria Kymco Dink 50cc 4T

APPLICABILITÀ

Kymco Agility R16 50 4T 08-09, Agility R16 50 4T 12-12, Dink Euro 2 50 4T 07-07, People S 4T 50 4T 06-08, Sento 50 4T 08-08, Super 8 4T 50 4T 07-07, Super 8 4T 50 4T 09-09, Super 8 4T 50 4T 13-13

RIFERIMENTO ORIGINALE

Kymco	101074
-------	--------



◀ cod. **FA10102**
Filtro Aria Honda SH 125/150cc

APPLICABILITÀ

Honda @ [NES] 125 125 4T 00-06, Dylan 125 [SES] 125 4T 02-04, PS I 125 [PES] 125 4T 06-10, SH 125 125 4T-2V 01-04, SH IE 125 Scoopy 125 4T-2V 05-12, @ [NES] 150 150 4T 00-06, Dylan 150 [SES] 150 4T 02-04, PS I 150 [PES] 150 4T 06-10, SH 150 150 4T-2V 01-04

RIFERIMENTO ORIGINALE

Honda	17210-KGF-900
-------	---------------

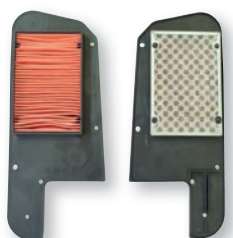

◀ cod. **FA10103**
Filtro Aria Honda Foresight 250cc

APPLICABILITÀ

Honda Foresight 250 [FES] 250 4T 98-99, Foresight 250 [FES] D.D. 250 4T 00-05, Jazz 250 ES Reflex [NSS] 250 4T-2V 01-04, Jazz 250 Reflex[NSS] 250 4T-2V 01-01

RIFERIMENTO ORIGINALE

Honda	17210-KFG-900
-------	---------------



◀ cod. **FA10104**
Filtro Aria Kymco Agility 125-150cc R16

APPLICABILITÀ

Kymco Filly LX 50 4T 01-02, People S 50 2T 05-08, Agility 125 R16 125 4T 08-09, Agility Plus 125 4T 14-14, Agility R16 125 4T 12-12, People 125 125 4T 99-00, People 125 EU2 125 4T 03-03, People 125 EU3 125 4T 07-08, People EU3 125 4T 11-11, People ONE I 125 4T 13-13, People S DD EU3 125 125 4T 07-08, Super 8 125 125 4T 08-09, Agility 150 R16 150 4T 08-09, People 150 150 4T 99-00, People 150 EU2 150 4T 03-03, Agility 200I R16 200 4T 10-10, Agility I Plus 200 4T 14-14, Agility R16 200 4T 12-12, People S 200 200 4T 05-05, People S 200I 200 4T 07-07

RIFERIMENTO ORIGINALE

Kymco	162377
-------	--------



◀ cod. **FA10105**
Filtro Aria Cinghia DX Yamaha T-MAX 500cc 01-11

APPLICABILITÀ

Yamaha T-Max 485 500 500 4T 09-11, T-Max 485 ABS 500 500 4T 08-11, T-Max 5GJ 500 500 4T 01-03, T-Max 5VU 500 500 4T 04-08, T-Max 5VU ABS 500 500 4T 05-07

RIFERIMENTO ORIGINALE

Yamaha	5GJ154080000
--------	--------------

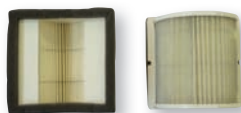

◀ **cod. FA10106**
Filtro Aria Yamaha T-MAX 500cc 01-07

APPLICABILITÀ

Yamaha T-Max 5GJ 500 500 4T 01-03, T-Max 5VU 500 500 4T 04-07, T-Max 5VU ABS 500 500 4T 05-07

RIFERIMENTO ORIGINALE

Yamaha	4BH144510100
--------	--------------

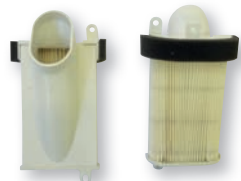

◀ **cod. FA10107**
Filtro Aria Cinghia SX Yamaha T-MAX 500cc 01-07

APPLICABILITÀ

Yamaha T-Max 5GJ 500 500 4T 01-03, T-Max 5VU 500 500 4T 04-07, T-Max 5VU ABS 500 500 4T 05-07

RIFERIMENTO ORIGINALE

Yamaha	5GJ154070100
--------	--------------



◀ **cod. FA10109**
Filtro Aria Kymco Dink 125cc EU3 06-10

APPLICABILITÀ

Kymco Dink 125 EU3 125 4T 06-07, Grand Dink 125 125 4T 01-02, Grand Dink 125 EU2 125 4T 03-04, Grand Dink 150 150 4T 01-02, Grand Dink 150 EU2 150 4T 03-04, Dink 200 IE EU3 200 4T 06-07, Grand Dink 250 250 4T 01-02, Grand Dink 250 EU2 250 4T 03-04, Xciting 250 250 4T 05-05, Xciting 250 I 250 4T 06-07, Xciting 300 I 300 4T 08-08, Xciting R 300i 300 4T 08-09

RIFERIMENTO ORIGINALE

Kymco	162475
-------	--------



◀ **cod. FA10110**
Filtro Aria Kymco People S 250cc 06-09

APPLICABILITÀ

Kymco People LC 250 250 4T 03-04, People S 250 250 4T 06-06, People S 250 I 250 4T 07-07, People S 300 I 300 4T 08-08

RIFERIMENTO ORIGINALE

Kymco	162380
-------	--------



◀ **cod. FA10111**
Filtro Aria Kymco Agility 50cc 4T R12 05-10

APPLICABILITÀ

Kymco Agility 4T Carry 50 4T 11-11, Agility 4T R12 50 4T 07-08, Agility R12 50 4T 05-05, Agility RS 50 4T 09-09, Dink Classic EU2 50 2T 03-03

RIFERIMENTO ORIGINALE

Kymco	164044
-------	--------



◀ **cod. FA10112**
Filtro Aria Kymco Agility 50cc 4T R10 06-10

APPLICABILITÀ

Kymco Agility 4T R10 50 4T 06-08

RIFERIMENTO ORIGINALE

Kymco	163126
-------	--------



◀ cod. **FA10113**
Filtro Aria Variatore Yamaha Majesty 250cc

APPLICABILITÀ

Malaguti Password 250 250 4T 05-06, Password 250 EU3 250 4T 07-08

Yamaha Majesty 250 250 4T 00-01, Majesty 250 250 4T 02-03, Majesty 250 ABS 250 4T 03-03, X-City 250 250 4T 07-13, X-Max 250 250 4T 05-14, X-Max 250 ABS 250 4T 11-14, X-Max 250 Black 250 4T 09-09, X-Max 250 Sport 250 4T 11-12, Versity 300 300 4T 03-06

RIFERIMENTO ORIGINALE

Yamaha	5GM154070000
--------	--------------



◀ cod. **FA10114**
Filtro Aria Yamaha T-MAX 500cc 08-11; T-MAX 530cc

APPLICABILITÀ

Yamaha T-Max 4BS 500 500 4T 09-11, T-Max 4BS ABS 500 500 4T 08-11, T-Max 5VU 500 500 4T 08-08, T-Max 59C 530 530 4T 12-14

RIFERIMENTO ORIGINALE

Yamaha	4BS144510000
--------	--------------



◀ cod. **FA10115**
Filtro Aria Yamaha X-MAX 250cc 05-10

APPLICABILITÀ

Yamaha X-City 125 EU3 125 4T-4V 08-11, X-Max R 125 ABS 125 4T-4V 11-11, X-Max R 125 EU3 125 4T-4V 06-12, X-City 250 250 4T 07-12, X-Max 250 250 4T 05-12, X-Max 250 ABS 250 4T 11-12, X-Max 250 Black 250 4T 09-09, X-Max 250 Sport 250 4T 11-12

RIFERIMENTO ORIGINALE

Yamaha	1B9144510000
--------	--------------

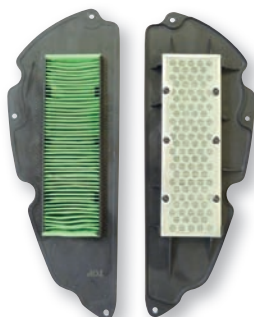

◀ cod. **FA10116**
Filtro Aria Honda SH 300cc i.e.

APPLICABILITÀ

Honda SH IE 300 Scoopy 300 4T-4V 07-12

RIFERIMENTO ORIGINALE

Honda	17210-KTW-900
-------	---------------



◀ **cod. FA10117**
Filtro Aria DX Yamaha Majesty 400cc 04-10

APPLICABILITÀ

Yamaha Majesty 400 400 4T 04-11, Majesty 400 ABS 400 4T 07-11

RIFERIMENTO ORIGINALE

Yamaha	5RU144612000
--------	--------------



◀ **cod. FA10118**
Filtro Aria Variatore Yamaha Majesty 400cc 04-10

APPLICABILITÀ

Yamaha Majesty 400 400 4T 04-11, Majesty 400 ABS 400 4T 07-11, X-MAX 400 4T-4V 13-13

RIFERIMENTO ORIGINALE

Yamaha	5RU154070200
--------	--------------

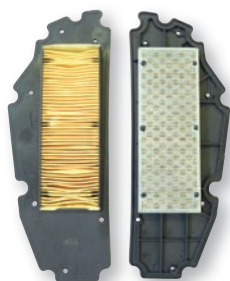

◀ **cod. FA10119**
Filtro Aria Sym Joymax 250/300cc

APPLICABILITÀ

Sym GTS 250 250 4T-4V 07-08, JoyMax 250 250 4T-4V 05-07, JoyMax EU3 I 250 250 4T-4V 07-08, JoyMax EVO 300 300 4T-4V 09-09, JoyMax EVO I 300 300 4T-4V 10-10, JoyMax I 300 4T-4V 12-12, JoyMax I 300 4T-4V 14-14, JoyMax I ABS 300 4T-4V 13-13

RIFERIMENTO ORIGINALE

Sym	17211HMA000
-----	-------------

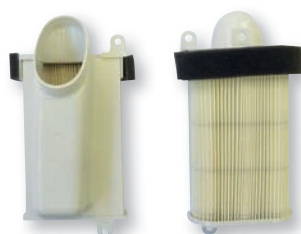

◀ **cod. FA10120**
Filtro Aria Cinghia SX Yamaha T-MAX 500cc 08-11

APPLICABILITÀ

Yamaha T-Max 4B5 500 500 4T 09-11, T-Max 4B5 ABS 500 500 4T 08-11, T-Max 5VU 500 500 4T 08-08

RIFERIMENTO ORIGINALE

Yamaha	4B5154070000
--------	--------------



◀ cod. **FA10121**
Filtro Aria SX Yamaha Majesty 400cc 04-10

APPLICABILITÀ

Yamaha Majesty 400 400 4T 04-11, Majesty 400 ABS 400 4T 07-11

RIFERIMENTO ORIGINALE

Yamaha	5RU144513000
--------	--------------

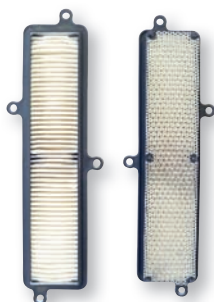

◀ cod. **FA10122**
Filtro Aria Suzuki Burgman 125/200cc 07-10

APPLICABILITÀ

Suzuki UH Burgman 125 K7/LO 125 4T 07-10, UH Burgman 125 L1 125 4T 11-11, UH Burgman 125 L3 125 4T 13-13, UH Burgman 125 L4 125 4T 14-14, UH Burgman 200 K7/LO 200 4T 07-10, UH Burgman 200 L1 200 4T 11-12, UH Burgman 200 L3 200 4T 13-13, UH Burgman 200 L4 200 4T 14-14

RIFERIMENTO ORIGINALE

Suzuki	13780-03H00-000
--------	-----------------



◀ cod. **FA10123**
Filtro Aria Kymco Downtown 300cc

APPLICABILITÀ

Kymco Downtown 300I 300 4T 09-09, Downtown ABS 300 300 4T 10-10, Downtown I 300 300 4T 11-11, Downtown I ABS 300 300 4T 11-11

RIFERIMENTO ORIGINALE

Kymco	117245
-------	--------

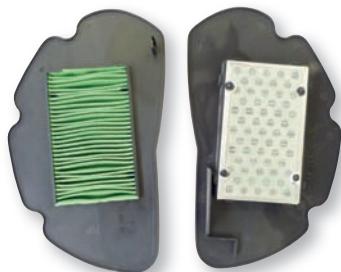

◀ cod. **FA10124**
Filtro Aria Honda PCX 125cc

APPLICABILITÀ

Honda PCX 125 125 4T-2V 10-13

RIFERIMENTO ORIGINALE

Honda	17210-KMN-900
-------	---------------

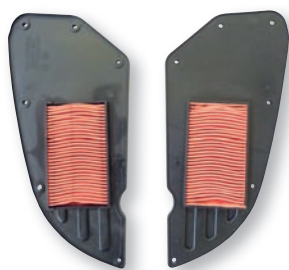

◀ cod. **FA10126**
Filtro Aria Kymco DOWNTOWN 125cc

APPLICABILITÀ

Kymco DOWNTOWN 125 I 125 4T 09-09, DOWNTOWN I 200 200 4T 10-10

RIFERIMENTO ORIGINALE

Kymco	117199
-------	--------

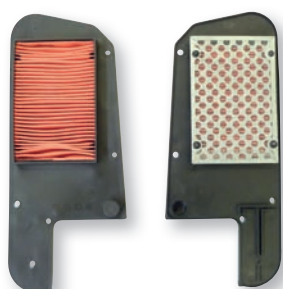

◀ cod. **FA10127**
Filtro Aria Honda S-WING 125/150cc 4T

APPLICABILITÀ

Honda Silver Wing 125 [FES] 125 4T-2V 07-12, Silver Wing 150 [FES] 150 4T-2V 07-12

RIFERIMENTO ORIGINALE

Honda	17210-KRJ-900
-------	---------------

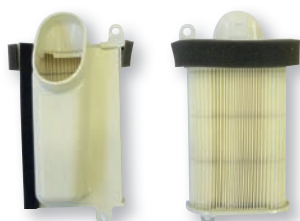

◀ cod. **FA10128**
Filtro Aria Cinghia SX Yamaha T-MAX 530cc

APPLICABILITÀ

Yamaha T-Max 59C 530 530 4T 12-14

RIFERIMENTO ORIGINALE

Yamaha	59C154070000
--------	--------------

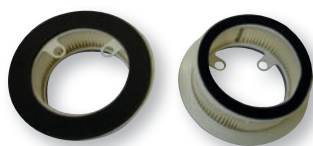

◀ cod. **FA10129**
Filtro Aria Cinghia DX Yamaha T-MAX 530cc

APPLICABILITÀ

Yamaha T-Max 59C 530 530 4T 12-14

RIFERIMENTO ORIGINALE

Yamaha	59C154080000
--------	--------------



gamma prodotti



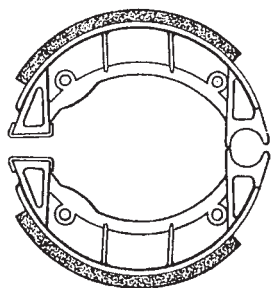

◀ cod. **CP00200**
Coppia ceppi \varnothing 90 x 18
con molle

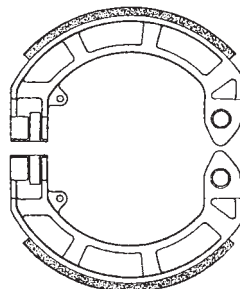

◀ cod. **CP00212**
Coppia ceppi \varnothing 150 x 24
Piaggio Vespa PX - PK
anteriore e posteriore

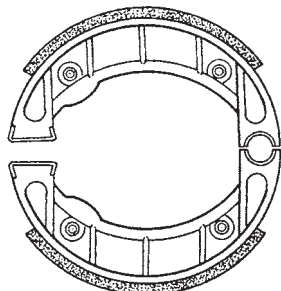

◀ cod. **CP00201**
Coppia ceppi \varnothing 105 x 20
con molle

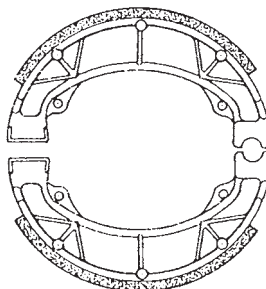

◀ cod. **CP00219**
Coppia ceppi \varnothing 110 x 25

APPLICABILITÀ

Aprilia Amico, Gulliver, SR post.
Malaguti F10, F12, F15 post.
Peugeot Geo, Zenith, Buxy, Speedake post.

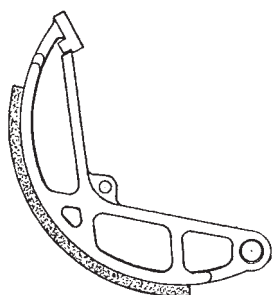

◀ cod. **CP00208**
Ceppo Ciao
 \varnothing 136x17 (serie da 2 pezzi)
posteriore

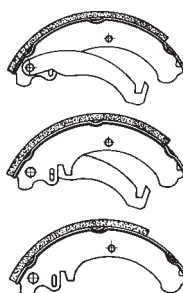

◀ cod. **CP00223**
Serie ceppi \varnothing 160 x 32 (serie da 4 pezzi)
Piaggio Ape 50
posteriore

x 2 pezzi

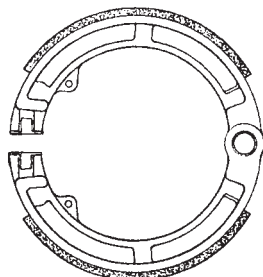

◀ cod. **CP00209**
Coppia ceppi \varnothing 125x17
Piaggio Vespa

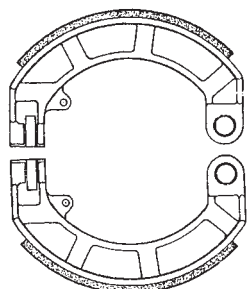

◀ cod. **CP00210**
Coppia ceppi \varnothing 150x24
Piaggio Vespa

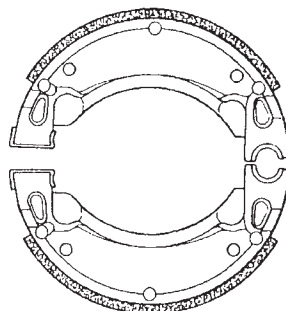

◀ cod. **CP00239**
Coppia ceppi \varnothing 110 x 25
MBK Booster 50 cc
anteriore e posteriore

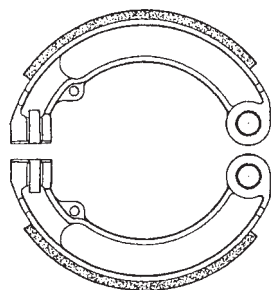

◀ cod. **CP00211**
Coppia ceppi \varnothing 125x19
Piaggio Vespa

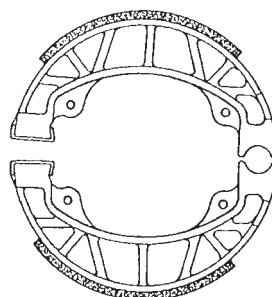

◀ cod. **CP00240**
Coppia ceppi \varnothing 110 x 25
Piaggio Skipper 50 cc
posteriore

GANASCE FRENO

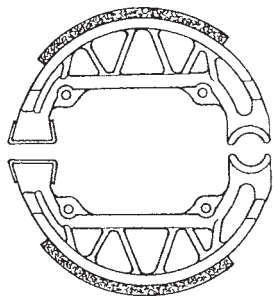

◀ cod. **CP00242**
Coppia ceppi \varnothing 100 x 20
Sfera 95 (post.)
Quartz-Zip-Typhoon

APPLICABILITÀ

Gilera Typhoon 50 cc (modelli dopo il '95)
Piaggio Sfera, Zip, Quartz

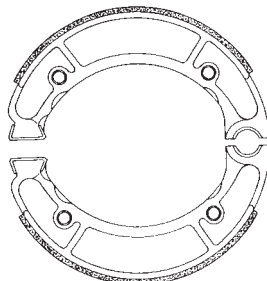

◀ cod. **CP00244**
Coppia ceppi \varnothing 160 x 30
Yamaha Majesty 250 cc

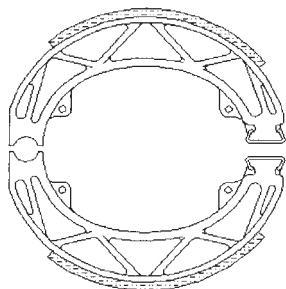

◀ cod. **CP00243**
Coppia ceppi \varnothing 140 x 25
Piaggio Liberty 50 cc

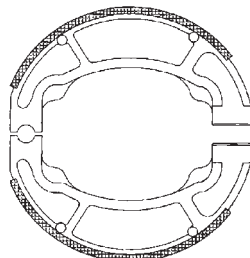

◀ cod. **CP00248**
Coppia ceppi \varnothing 125 x 25
Honda @ 125/150 cc

CILINDRETTI FRENO



◀ cod. **CF12750**
Cilindretto freno Piaggio Ape posteriore

RIFERIMENTO ORIGINALE

Piaggio	127908
---------	--------

APPLICABILITÀ

Piaggio Ape Car P2 (1° serie) 220 2T -00, Ape P 501 220 2T 78-85, Ape P 601 220 2T -00

◀ cod. **CF12754**
Cilindretto freno Piaggio Ape posteriore

RIFERIMENTO ORIGINALE

Piaggio	245193
---------	--------

APPLICABILITÀ

Piaggio Ape TM 220 2T 09-10, Ape TM P 602 220 2T 82-83, Ape TM P 703 - P 703 V, FL2 220 2T 84-05

◀ cod. **CF12755**
Cilindretto freno Piaggio Ape TM anteriore

RIFERIMENTO ORIGINALE

Piaggio	245194
---------	--------

APPLICABILITÀ

Piaggio Ape TM 220 2T 09-10, Ape TM P 602 220 2T 82-83, Ape TM P 703 - P 703 V, FL2 220 2T 84-05

◀ cod. **CF12757**
Cilindretto freno Piaggio Ape posteriore

RIFERIMENTO ORIGINALE

Piaggio	245765
---------	--------

APPLICABILITÀ

Piaggio Ape EU2 50 2T 03-10, Ape FL - FL2 50 2T 89-95, Ape FL3 50 2T 96-99, Ape RST MIX 50 2T 99-03

FILTRI BENZINA



◀ cod. **FT07500**
Filtro benzina codulo piccolo ø 6
(24 pezzi)

◀ cod. **FT07501**
Filtro benzina codulo grosso ø 8
(24 pezzi)

FRIZIONI



◀ cod. **FZ00301**
Serie dischi frizione vespa 50-90-125 pk (3 pezzi)

◀ cod. **FZ00302**
Disco frizione singolo vespa 50-90-125 pk
(Conf. da 50 pezzi)



◀ cod. **FZ00303**
Serie dischi frizione
Vespa 125-150 px (3 pezzi)



◀ cod. **FZ00306**
Serie speciale dischi frizione
Vespa 50-90-125, 50-125 pk (7 pezzi)

RICAMBI
ML00820 MOLLA RINFORZATA PER VESPA 50



▲ cod. **FZ00305**
Serie dischi frizione
Vespa p 200 e (3 pezzi)

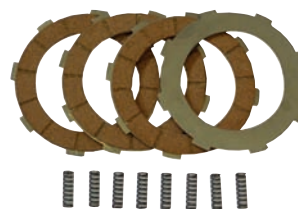

▲ cod. **FZ00313**
Serie dischi frizione
Vespa px 125 - 150 dal '98

RICAMBI
ML06181 SERIE 8 MOLLE RINFORZATE



◀ cod. **FZ00307**
Serie speciale dischi frizione
Vespa px 125 - 150 (7 pezzi)

RICAMBI
ML00821 SERIE 6 MOLLE RINFORZATE PX 125 - 150

FRIZIONI

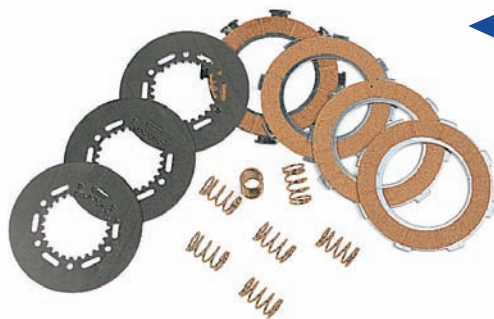

◀ cod. **FZ00318**
Serie speciale dischi frizione
Vespa p 200e

RICAMBI

ML00821 SERIE 6 MOLLE RINFORZATE PX 125 -150

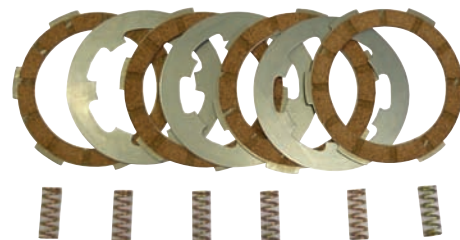

▲ cod. **FZ00329**
Serie dischi frizione
Vespa 50 - 125 fl-hp con 6 molle



◀ cod. **FZ00320**
Massette di trascimento con molla per Piaggio - Ciao - Bravo - Si
senza variatore

RIFERIMENTO ORIGINALE

Piaggio	104480
---------	--------

SERIE GUARNIZIONI MOTORE

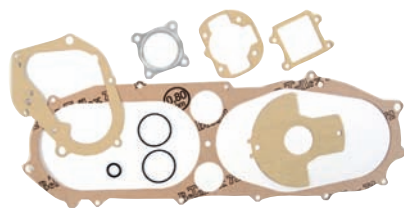

◀ cod. **GR06412**
Serie guarnizioni per motore scooter 50 cc Minarelli/Yamaha tipo verticale

◀ cod. **GR06413**
Serie guarnizioni per motore scooter 50 cc Minarelli/Yamaha orizzontale corto

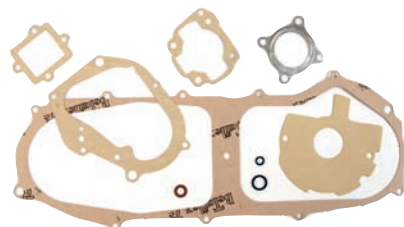

◀ cod. **GR06414**
Serie guarnizioni motore scooter 50 cc Minarelli/Yamaha orizzontale lungo

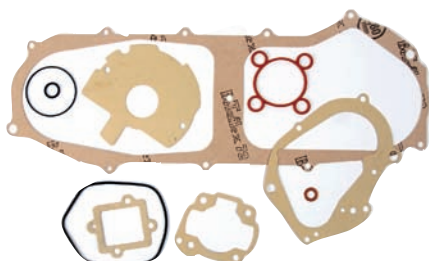

◀ cod. **GR06415**
Serie guarnizioni motore scooter 50 cc Minarelli/Yamaha Liquid Cooled

SERIE GUARNIZIONI MOTORE

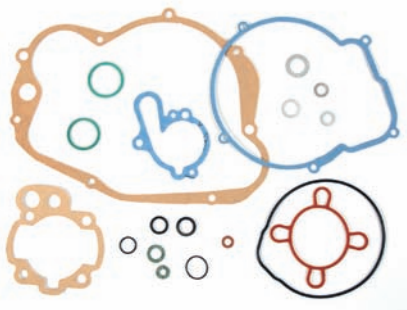

- ◀ cod. **GR06416**
Serie guarnizioni completa per AM6 EU-1

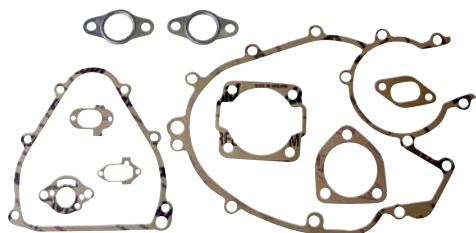

- ◀ cod. **GR00740**
Serie guarnizioni motore Piaggio Vespa 50 - 50 Special - 90

RIFERIMENTO ORIGINALE

Piaggio	091925
---------	--------

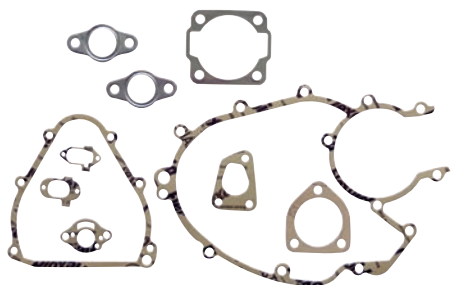

- ◀ cod. **GR00741**
Serie guarnizioni motore Vespa PK50-XL-FL

RIFERIMENTO ORIGINALE

Piaggio	154616
---------	--------

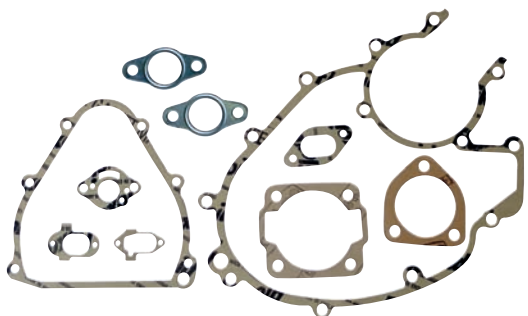

- ◀ cod. **GR00742**
Serie guarnizioni motore Vespa 125 Primavera

RIFERIMENTO ORIGINALE

Piaggio	153509
---------	--------

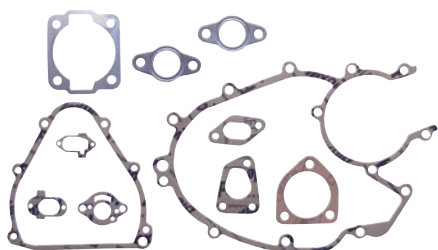

- ◀ cod. **GR00743**
Serie guarnizioni motore Vespa PK125-XL

RIFERIMENTO ORIGINALE

Piaggio	154630
---------	--------

SERIE GUARNIZIONI MOTORE

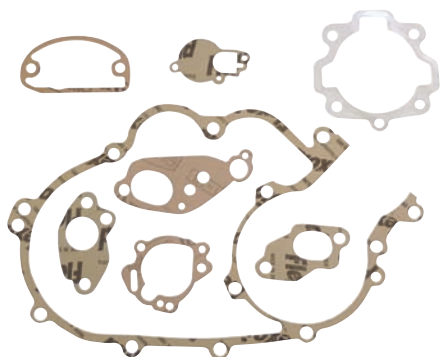

◀ cod. **GR00744**
Serie guarnizioni motore Vespa PX125-150

RIFERIMENTO ORIGINALE

Piaggio	497603
---------	--------



◀ cod. **GR00745**
Serie guarnizioni motore Piaggio Vespa PX 98-01 - PX200

RIFERIMENTO ORIGINALE

Piaggio	155446
---------	--------

GUARNIZIONI BASE CILINDRO



◀ cod. **GR06337**
Guarnizione base cilindro
Vespa 50/90 125 Primavera - ET3

GUARNIZIONI ASPIRAZIONE



◀ cod. **GR00739**
Guarnizione per raccordo aspirazione con flangia a tre fori Vespa PK50-PK125

RIFERIMENTO ORIGINALE

Piaggio	196931
---------	--------

GUARNIZIONI SCARICO



- ◀ cod. **GR00671**
Guarnizione scarico klingerite fori ø 6 mm
Vespa PK 50

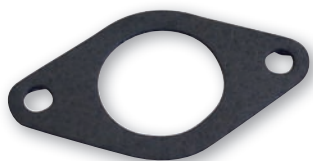

- ◀ cod. **GR00673**
Guarnizione raccordo scarico klingerite
Vespa PK 125



- ◀ cod. **GR00675**
Guarnizione scarico klingerite fori ø 8 mm
Vespa 125 PK - ET3 - PX

SCARICHI PROMA



- ◀ cod. **MT00001**
Marmitta Proma per Vespa 50

APPLICABILITÀ

Piaggio Vespa 50 2T 67-82

- ◀ cod. **MT00002**
Marmitta Proma per Vespa 125

APPLICABILITÀ

Piaggio Vespa PK 125 125 2T 82-84, Vespa PK XL 125 125 2T 86-89



cod. **KT0004**
Gruppo termico ø 38,4 Ciao spinotto 12

APPLICABILITÀ

Piaggio Boss 50 2T 88-89, Boxer 50 2T -00, Bravo 3 50 2T 87-90, Bravo Erre 2 50 2T 75-81, Ciao 50 2T 80-88, Ciao EU1 50 2T 99-01, Ciao EU2 50 2T 02-04, Ciao Mix Teen 50 2T 96-01, Ciao TRE 50 2T 71-99, Grillo 50 2T 89-93, Si 50 2T 79-88, Si FL2 50 2T 91-97, Si MIX 50 2T 96-99

RICAMBI

PT00053	Pistone completo ø 38,4 - spin. 12
SG15201	Serie segmenti ø 38,4

GR06336	Guarnizioni base
---------	------------------

cod. **KT0005**
Gruppo termico ø 38,4 Ciao spinotto 10

APPLICABILITÀ

Piaggio Boss 50 2T 88-89, Boxer 50 2T -00, Bravo 3 50 2T 87-90, Bravo Erre 2 50 2T 75-81, Ciao 50 2T 80-88, Ciao EU1 50 2T 99-01, Ciao EU2 50 2T 02-04, Ciao Mix Teen 50 2T 96-01, Ciao TRE 50 2T 71-99, Grillo 50 2T 89-93, Si 50 2T 79-88, Si FL2 50 2T 91-97, Si MIX 50 2T 96-99

RICAMBI

PT00054	Pistone completo ø 38,4 - spin. 10
SG15201	Serie segmenti ø 38,4

GR06336	Guarnizioni base
---------	------------------



cod. **KT0010**
Gruppo termico ø 38,4 per Vespa 50

APPLICABILITÀ

Piaggio Vespa 50 2T 67-82, Vespa FL 50 2T 90-90, Vespa FL2 AUTOMATICA 50 2T 90-91, Vespa FL2 HP 50 2T 91-97, Vespa N 50 2T 89-90, Vespa PK 50 2T 82-84, Vespa PK AUTOMATICA 50 2T 84-89, Vespa PK XL 50 2T 85-88, Vespa PK XL PLURIMATIC 50 2T 85-90, Vespa PK XL RUSH 50 2T 88-89

RICAMBI

PT00057	Pistone completo ø 38,4
SG15002	Serie segmenti ø 38,4

GR00727	Serie guarnizioni
---------	-------------------



cod. **KT00113**
Gruppo termico ø 39 Honda SH-SFX-Bali senza testa

APPLICABILITÀ

Honda Bali 50 2T 93-99, SFX / SXR 50 2T 95-01, SH New 50 2T 96-01, X8R S 50 2T 98-01, X8R X 50 2T 98-01

RICAMBI

PT00105	Pistone ø 39
SG15868	Serie segmenti ø 39

GR00724	Serie guarnizioni
---------	-------------------

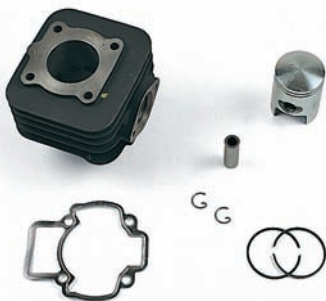

cod. **KT00080**
Gruppo termico ø 40 scooter Piaggio senza testa

APPLICABILITÀ

Aprilia Mojito 50 2T 04-08, Scarabeo 2T EU2 Motore Piaggio 50 2T 10-12, Scarabeo 2T Net 50 2T 09-10, Scarabeo Street 50 2T 05-06, Scarabeo Street 2T Restyling 50 2T 06-09, Sport City One 2T 50 2T 08-11

Derbi Atlantis 2T 50 2T 10-10, Atlantis 2T EU2 50 2T 07-09, Atlantis O2 50 2T 02-02, Atlantis O2 Bullet 50 2T 03-05, Atlantis O2 City 50 2T 03-06, Atlantis O2 Red Bullet 50 2T 03-03, Atlantis O2 Two Chic 50 2T 05-05, Boulevard 50 2T 09-12, Sonar 2T 50 2T 09-09

Gilera Easy Moving 50 2T 95-96, Ice 50 2T 01-05, Stalker 50 2T 97-11, Stalker Naked 50 2T 08-08, Stalker Special Edition 50 2T 07-08, Storm 50 2T 94-95, Storm Euro 2 50 2T 07-07, Typhoon 50 2T 94-97, Typhoon X 50 2T 98-99, Typhoon XR 50 2T 00-00

Italjet Jet Set 50 2T -00, Torpedo New 50 2T -00

Piaggio Diesis 50 2T 01-01, Fly 2T 50 2T 05-07, Fly 2T 50 2T 10-11, Free 50 2T 92-94, Free Delivery 50 2T 00-01, Free FL 50 2T 95-02, Liberty 50 2T 97-05, Liberty 2T 50 2T 06-08, Liberty 2T PTT EU2 50 2T 04-05, Liberty 2T RST 50 2T 04-04, Liberty 2T Sport 50 2T 06-08, Liberty MOC 2T & Elle 50 2T 09-12, NRG Power DT 50 2T 06-11, NRG Power DT Serie Speciale 50 2T 07-08, Sfera 50 2T 91-93, Sfera Maquillage 2 50 2T 94-94, Sfera RST 50 2T 95-97, Typhoon 50 2T 01-09, Typhoon 2T E2 50 2T 10-12, Typhoon 2T E3 CH 50 2T 11-11, Vespa ET2 50 2T 97-05, Vespa ET2 iniezione 50 2T 97-00, Vespa LX 2T 50 2T 05-08, Vespa LX 2T FL 50 2T 09-10, Vespa LX 2T Touring 50 2T 10-11, Vespa LXV 2T 50 2T 06-08, Vespa LXV 2T NAVY 50 2T 08-08, Vespa S 2T & College 50 2T 07-12, Zip 50 2T 92-93, Zip 50 2T 95-96, Zip Bimodale 50 2T 94-97, Zip Fast Rider 50 2T 93-94, Zip Fast Rider RST 50 2T 96-97, Zip RST 50 2T 96-99

RICAMBI

PT00098	Pistone completo ø 40
PT98	Pistone completo ø 40,5
PT0098	Pistone completo ø 41
SG15682	Serie segmenti ø 40

SG15683	Serie segmenti ø 40,5
SG15684	Serie segmenti ø 41
GR00703	Guarnizione base

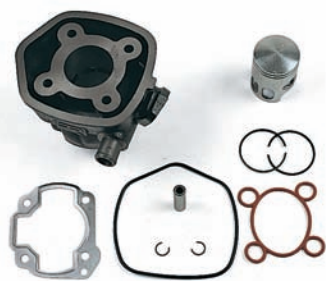

cod. **KT00094**

Gruppo termico ø 40 per motore scooter 50 cc Minarelli/Yamaha Liquid Cooled senza testa

APPLICABILITÀ

Aprilia	Area 51 50 2T 98-00, Gulliver LC 50 2T 96-98, Rally Liquid Cooled 50 2T 96-99, SR Liquid Cooled 50 2T 94-96, SR Recing 50 2T 97-99, SR Stealth 50 2T 97-99, Sonic GP 50 2T 98-08
Benelli	491 RR 50 2T 99-01, 491 Racing 50 2T 98-99, 491 SP 50 2T 99-99, 491 Sport 50 2T 98-99, K2 Liquid Cooled 50 2T 98-01
Beta	Ark LC 50 2T 96-08, Eikon 50 2T 99-03
Italjet	Dragster 50 2T -00

Malaguti	F12 Phantom Euro 2 50 2T 02-02, F12 Phantom LC 50 2T -00, F12 Phantom LC Euro 2,3 50 2T 03-04, F12 R Phantom LC 50 2T 07-07, F12 Restyling Euro 1 50 2T 99-02, F12 Restyling LC Euro 2 50 2T 06-06, F15 Firefox 50 2T -00, F15 Firefox Euro 2 50 2T 02-06, F15 Firefox Euro 2 2,3 50 2T 03-04
Mbk	Mach G LC 50 2T 02-04, Nitro 50 2T -00, Nitro Euro 2 50 2T 03-03
Yamaha	Aerox 50 2T -00, Aerox Euro 2 50 2T 03-03, Jog R LC 50 2T -00

RICAMBI

PT00097	Pistone completo ø 40
PT97	Pistone completo ø 40,5
PT0097	Pistone completo ø 41
SG15682	Serie segmenti ø 40

SG15683	Serie segmenti ø 40,5
SG15684	Serie segmenti ø 41
GR00716	Serie guarnizioni



cod. **KT00095**

Gruppo termico ø 40 per motore scooter 50 cc orizzontale aria Minarelli/Yamaha senza testa

APPLICABILITÀ

Aprilia	Gulliver 50 2T 95-98, Rally 50 2T 95-03, SR (Orizzontale) 50 2T 94-96, SR WWW 50 2T 97-01, Scarabeo 50 2T 93-05, Sonic 50 2T 98-07
Atala	Carosello 50 2T -00
Benelli	491 GT 50 2T 98-99, 491 ST 50 2T 99-01, K2 50 2T 98-01, Naked 50 2T 02-02, Pepe 50 2T 99-01, Pepe LX 50 2T 03-04
Beta	Ark 50 2T 96-08, Chrono 50 2T 96-00, Quadra 50 2T 95-00, Tempo 50 2T 95-00
KTM	K50 50 2T -00
Macal	Thunder 50 2T -00
Malaguti	Centro 50 2T -00, Ciak 50 2T -00, Ciak Euro 2 2,3 50 2T 03-03, Ciak Euro 2 50 2T 01-03, Ciak Master Euro 2 50 2T 06-06, F10 50 2T -00, F10 Euro 2 50 2T -00, F10 Euro 2

Mbk	2,3 50 2T 03-04, F10 Restyling Euro 2 50 2T 06-06, F12 Phantom 50 2T -00, F12 Phantom Euro 2 2,3 50 2T 03-04, F12 Restyling Euro 2 50 2T 06-06, F15 Firefox Euro 2 50 2T 05-06, Yesterday 50 2T 97-00
Motron	Evolis 50 2T 92-95, Fizz 50 2T 94-95, Flipper 50 2T -00, Flipper Euro 2 50 2T 03-03, Forte 50 2T 94-96, Mach G 50 2T 02-04, Ovetto 50 2T -00, Ovetto Euro 2 50 2T 02-02
PGO	Syncro 50 2T -00, Thunder 50 2T -00
Rieju	Big Max 50 2T -00
Yamaha	First 50 2T -00, Windy 50 2T -00
Yamaha	Axis 50 2T 95-96, Breeze 50 2T 94-95, Jog 50 2T -00, Jog ER 50 2T -00, Jog R 50 2T 02-10, Jog Z 50 2T 95-95, Neo's 50 2T -00, Neo's Euro 2 50 2T 02-02, Why 50 2T -00, Why Euro 2 50 2T 03-03, Zest 50 2T -00

RICAMBI

PT00097	Pistone completo ø 40
PT97	Pistone completo ø 40,5
PT0097	Pistone completo ø 41
SG15682	Serie segmenti ø 40

SG15683	Serie segmenti ø 40,5
SG15684	Serie segmenti ø 41
GR00704	Serie guarnizioni

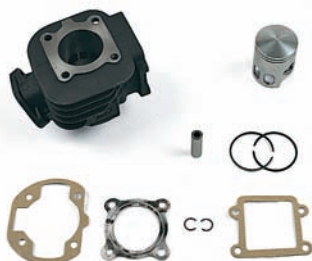

cod. **KT00096**

Gruppo termico ø 40 per motore scooter 50 cc Minarelli/Yamaha verticale aria senza testa

APPLICABILITÀ

Aprilia	Amico 50 2T 94-94, Amico 50 2T 96-98, Amico GL/GLE 50 2T 93-95, Amico LX/Sport/Cat 50 2T 92-93, SR (Verticale) 50 2T 93-93
Mbk	Booster 50 2T -00, Booster Euro 2 50 2T 04-04, Booster NG 50 2T 03-00, Booster Rocket 50 2T 97-98, Booster Spirit 50 2T 03-00, Booster Track 50 2T 96-98, Stunt 50 2T 00-02

Yamaha	BWS 50 2T -00, BWS Bump 50 2T 97-98, BWS Euro 2 50 2T 03-03, BWS NG 50 2T -00, BWS NG Euro 2 50 2T 03-03, Slider 50 2T 00-02, Spy 50 2T 95-98, Zuma 50 2T 97-01
---------------	---

PT00097	Pistone completo ø 40
PT97	Pistone completo ø 40,5
PT0097	Pistone completo ø 41
SG15682	Serie segmenti ø 40

SG15683	Serie segmenti ø 40,5
SG15684	Serie segmenti ø 41
GR00705	Serie guarnizioni



◀ cod. **KT00112**
Gruppo termico ø 40 Piaggio H20 con testa

APPLICABILITÀ

Aprilia SR R 50 2T 04-09, SR R FACTORY 50 2T 04-09, SR R FACTORY Carburatore 50 2T 10-12, SR Street 50 2T 03-12

Derbi GP1 50 2T 01-03, GP1 EU2 50 2T 05-05, GP1 Open EU2 50 2T 06-09, GP1 Race EU2 50 2T 05-07

Gilera DNA 50 2T 00-02, DNA 50 2T 05-07, DNA GP Experience 50 2T 03-04, Runner 50 2T 97-00, Runner Poggiali 50 2T 02-02, Runner SP 50 2T 02-07, Runner SP 50 2T 10-12, Runner SP ST & Simoncelli 50 2T 08-09, Runner SP Special Edition 50 2T 07-07

Piaggio NRG 50 2T 94-96, NRG Extreme 50 2T 99-00, NRG MC3 50 2T 01-04, NRG Power DD 50 2T 05-11, NRG Power DD Serie Speciale 50 2T 07-11, NRG Power Pure Jet 50 2T-IE 04-05, NRG Power PureJet 50 2T-IE 06-11, NRG PureJet 50 2T-IE 02-04, NRG PureJet 50 2T-IE 10-10, NRG RST MC2 50 2T 96-98, NTT 50 2T 95-96, Quartz 50 2T 92-96, Zip 2T 50 2T 08-12, Zip LC 50 2T 00-04, Zip Sp 50 2T 96-04, Zip Sp Euro 2 50 2T 06-12

RICAMBI

PT00098	Pistone ø 40
PT98	Pistone ø 40,5
PT0098	Pistone ø 41
SG15682	Serie segmenti ø 40

SG15683	Serie segmenti ø 40,5
SG15684	Serie segmenti ø 41
GR00734	Serie guarnizioni
TS00180	Testa ø 40



◀ cod. **KT00115**
Gruppo termico ø 40 per Derbi Senda con testa

APPLICABILITÀ

Derbi Bultaco Lobito 50 2T 98-01, GPR NUDE 50 2T 04-05, GPR R 50 2T 97-00, GPR Racing 50 2T 04-05, GPR Replica 50 2T 99-01, GPR Replica Racing 50 4T 02-02, GPR Replica Racing 50 2T 03-03, GPR Replica Racing EU2 50 2T 05-05, Sebda R Racer 50 2T 03-03, Senda Black Edition 50 2T 03-03, Senda R 50 2T 99-01, Senda R DRD EU1 EU1R 50 2T 02-02, Senda R DRD Racing 50 2T 04-05, Senda R DRD Racing LTD 50 2T 05-05, Senda R X-RACE 50 2T 04-05, Senda R X-TREME 50 2T 03-03, Senda R X-TREME 50

2T 05-05, Senda R X-TREME EU2 50 2T 04-04, Senda SM 50 2T 00-01, Senda SM DRD EU1 EU1R 50 2T 02-03, Senda SM DRD Edition Black 50 2T 05-05, Senda SM DRD Racing 50 2T 04-05, Senda SM DRD Racing LTD 50 2T 05-05, Senda SM X-RACE 50 2T 04-05, Senda SM X-TREME 50 2T 02-03, Senda SM X-TREME EU2 50 2T 04-04

Gilera Gsm H@K 50 2T 01-01, RCR 50 2T 03-03, SMT 50 2T 03-03

RICAMBI

PT00154	Pistone completo ø 40
PT154	Pistone completo ø 40,28
SG15852	Serie segmenti ø 40

SG15854	Serie segmenti ø 40,28
GR00725	Nuova serie guarnizioni
TS00181	Testa



◀ cod. **KT00119**
Gruppo termico ø 40 per Peugeot H20 con testa

APPLICABILITÀ

Peugeot Speedfight 50 2T-00, X-Fight 50 2T-00

RICAMBI

PT00155	Pistone ø 39,88
PT155	Pistone ø 40,28
SG15853	Serie segmenti ø 39,88

SG15856	Serie segmenti ø 40,28
GR00714	Serie guarnizioni
TS00185	Testa ø 40



◀ cod. **KT00123**
Gruppo termico ø 40 Peugeot Buxy EU-2 senza testa

APPLICABILITÀ

Peugeot Buxy 50 2T-00, Buxy RS 50 2T-00, Elyseo 50 2T-00, Looxor 50 2T-00, Metal X 50 2T-00, SV Geo 50 2T-00, Speedake 50 2T-00, Speedfight 50 2T-00, Squab 50 2T-00, Trekker 50 2T-00, Vivacity 50 2T-00, X-Fight 50 2T-00, Zenith 50 2T-00

RICAMBI

PT00099	Pistone ø 40
PT99	Pistone ø 40,5
SG15682	Serie segmenti ø 40

SG15683	Serie segmenti ø 40,5
SG15684	Serie segmenti ø 41
GR00718	Serie guarnizioni



◀ **cod. KT00129**
Gruppo termico ø 40 Keeway Focus senza testa

APPLICABILITÀ

Benelli Pepe 50 2T 10-10, Pepe LX 50 2T 07-09, Pepe Old 50 2T 07-09, Pepe Old 50 2T 11-11, Quattrononex 50 2T 08-11

CPI Aragon 50 2T 03-03, Hussar 50 2T 03-03, Oliver 50 2T 03-03, Pop Corn 50 2T 03-03

Explorer Cracker 50 2T 03-03

Keeway F-Act 50 2T 07-08, Flash 50 2T 07-08, Focus 50 2T 06-06, Goccia 50 2T 09-09, Hurricane 50 2T 06-08, Matrix 50 2T 06-08, Pixel Euro 2 50 2T -00, RY8 50 2T 08-08

Malaguti F10 Wap Euro 2 50 2T -00, F12 R Phantom 50 2T 07-07

RICAMBI

PT00107	Pistone ø 40
PT107	Pistone ø 40,5
SG15682	Serie segmenti ø 40

SG15683	Serie segmenti ø 40,5
GR00733	Serie guarnizioni



◀ **cod. KT00098**
Gruppo termico ø 40,3 (AM 345/6) E EU1 con testa

APPLICABILITÀ

Aprilia Classic 50 2T 92-99, Europa 50 2T 91-92, MX 50 50 2T 04-04, MX 50 Motard 50 2T 95-03, Pegaso 50 2T 92-94, RS 50 50 2T 91-05, RX 50 50 2T 03-04, RX 50 3-5 Marce 50 2T 91-94, RX 50 Enduro 50 2T 95-03, RX 50 Racing 50 2T 03-06, Tuono 50 50 2T 03-04

Beta RR Alu 50 2T -00, RR Enduro 50 50 2T -00, RR Motard 50 50 2T -00

CH Husqvarna SM 50 50 2T -00, WR 50 50 2T -00, WSM 50 50 2T -00

CMC Enduro 50 50 2T 11-11, Motard 50 50 2T 11-11

Fantic Caballero Motard 50 2T 06-10, Caballero Regolarità 50 2T 06-10

HM Baja, Derapage Basic 50 2T 10-11, CMC 50 2T 10-11, CRE Baja RR, Derapage RR 50 2T 07-11, CRE Baja, Derapage 50 2T 07-11, CRE Six Competition 50 2T 10-11, CRE Six, Baia, Derapage 50 2T 95-06, CRE Six, Derapage Competition 50 2T 07-09, Derapage Competition 50 2T 10-11

MBK X Limit 50 2T -00, X Power 50 2T -00

Malaguti CNK Drakon 50 2T 05-07, Fifty Evolution 50 2T 90-93, XSM 50 50 2T -00, XTM 50 50 2T -00

Minarelli AM 345 Motori Minarelli 50 2T -00

Motorhispania Furia 50 50 2T -00, Furia Max 50 50 2T -00, RX 50 50 2T -00, RX 50 R 50 2T -00

Peugeot Supermotard 50 2T -00, XP6 Trail S/Avv. Elettrico 50 2T -00, XR6 Racing Cat. C/avv.elett. 50 2T -00

Rieju MRT 50 50 2T -00, MRT 50 PRO 50 2T -00, MRT 50 PRO SM 50 2T -00, MRT 50 SM 50 2T -00, MRX 50 50 2T -00, MRX 50 PRO 50 2T -00, RR 50 50 2T -00, RS1 50 50 2T -00, RS2 50 Matrix 50 2T -00, RS2 50 Matrix Pro 50 2T -00, RS2 Naked 50 50 2T -00, SMX 50 E.S./K.S. 50 2T -00, SMX 50 PRO E.S./K.S. 50 2T -00, Spike 50 50 2T -00

Sherco HRD Enduro 50 50 2T -00, HRD Motard 50 50 2T -00

Yamaha DT R 50 2T 03-10, DT RSM 50 2T 03-05, DT X 50 2T 06-10, TZR 50 2T 03-08, TZR 50 2T 10-11, TZR RR 50 2T 05-05

RICAMBI

PT00104	Pistone completo ø 40,3
PT104	Pistone completo ø 40,6
PT0104	Pistone completo ø 40,8
SG15706	Serie segmenti ø 40,3

SG15707	Serie segmenti ø 40,6
SG15708	Serie segmenti ø 40,8
GR00715	Serie guarnizioni
TS00179	Testa



◀ **cod. KT00066**
Gruppo termico ø 43 spinotto 12 Ciao-Si serie Evolution

APPLICABILITÀ

Piaggio Boss 50 2T 88-89, Boxer 50 2T -00, Bravo 3 50 2T 87-90, Bravo Erre 2 50 2T 75-81, Ciao 50 2T 80-88, Ciao EU1 50 2T 99-01, Ciao EU2 50 2T 02-04, Ciao Mix Teen 50 2T 96-01, Ciao TRE 50 2T 71-99, Eco 50 2T -00, Grillo 50 2T 89-93, Si 50 2T 79-88, Si FL2 50 2T 91-97, Si MIX 50 2T 96-99

RICAMBI

PT00092	Pistone completo ø 43
SG15585	Serie segmenti ø 43

GR00698	Guarnizione base
----------------	------------------



◀ **cod. KT00067**
Gruppo termico ø 43 spinotto 10 Ciao-Si

APPLICABILITÀ

Piaggio Boss 50 2T 88-89, Boxer 50 2T -00, Bravo 3 50 2T 87-90, Bravo Erre 2 50 2T 75-81, Ciao 50 2T 80-88, Ciao EU1 50 2T 99-01, Ciao EU2 50 2T 02-04, Ciao Mix Teen 50 2T 96-01, Ciao TRE 50 2T 71-99, Eco 50 2T -00, Grillo 50 2T 89-93, Si 50 2T 79-88, Si FL2 50 2T 91-97, Si MIX 50 2T 96-99

RICAMBI

PT00094	Pistone completo ø 43
SG15585	Serie segmenti ø 43

GR00698	Guarnizione base
----------------	------------------



◀ cod. **KT00048**
Gruppo termico ø 46 Honda Camino PX

APPLICABILITÀ

Honda Camino PX 50 2T-00

RICAMBI

PT00079	Pistone completo ø 46
SG15031	Serie segmenti ø 46

GR00683	Serie guarnizioni
---------	-------------------



◀ cod. **KT00057**
Gruppo termico ø 46 Suzuki Address senza testa

APPLICABILITÀ

Aprilia Mojito Custom 50 2T 99-03, Mojito Retrò 50 2T 99-03

Malaguti Crosser CR1 50 2T 95-98

Atala Hacker 50 2T-00, Vamos 50 2T-00

Suzuki AH Address 50 2T 92-95, AJ ZZ 50 2T 95-97, AP 50 2T 94-97, Street Magic 50 2T 98-98

Benelli 491 ST Morini 50 2T 03-03, Naked Morini 50 2T 03-04

Hyosung SD 50 Sense EU1 50 2T 00-01, SD 50 Sense EU2 50 2T 05-05, SF 50 50 2T 05-05, SF 50 EU2 50 2T 06-07, SF 50 Fast 50 2T 01-01, SF 50 Prima 50 2T 00-00

Italjet Formula 50 2T-00, Velocifero 50 2T-00

RICAMBI

PT00089	Pistone completo ø 46
PT89	Pistone completo ø 46,5
SG15282	Serie segmenti ø 46

SG15283	Serie segmenti ø 46,5
GR00731	Serie guarnizioni



◀ cod. **KT00073**
Gruppo termico ø 46 Wallaroo

APPLICABILITÀ

Honda Wallaroo 50 2T 90-01

RICAMBI

PT00072	Pistone completo ø 46
SG15168	Serie segmenti ø 46

GR06347	Guarnizione base
---------	------------------



◀ cod. **KT00011**
Gruppo termico Vespa ø 47 3 travasi

Cilindro in ghisa Minacrom con 3 travasi | Cilindrata 74,60 cc - Corsa mm 43 - Rapp. Comp. 1:10,7 | Completo di testa

APPLICABILITÀ

Piaggio Vespa 50 2T 67-82, Vespa FL 50 2T 90-90, Vespa FL2 AUTOMATICA 50 2T 90-91, Vespa FL2 HP 50 2T 91-97, Vespa N 50 2T 89-90, Vespa PK 50 2T 82-84, Vespa PK AUTOMATICA 50 2T 84-89, Vespa PK XL 50 2T 85-88, Vespa PK XL PLURIMATIC 50 2T 85-90, Vespa PK XL RUSH 50 2T 88-89

RICAMBI

PT00058	Pistone completo ø 47
PT58	Pistone completo ø 47,4
SG15036	Serie segmenti ø 47

SG15038	Serie segmenti ø 47,4
GR00727	Serie guarnizioni
TS00151	Testa



cod. **KT00013**

Gruppo termico Vespa ø 47 6 travasi

Cilindro in ghisa Minacrom con 6 travasi | Cilindrata 74,60 cc - Corsa mm 43 - Rapp. Comp. 1:10,7 | Completo di testa

APPLICABILITÀ

Piaggio Vespa 50 2T 67-82, Vespa FL 50 2T 90-90, Vespa FL2 AUTOMATICA 50 2T 90-91, Vespa FL2 HP 50 2T 91-97, Vespa N 50 2T 89-90, Vespa PK 50 2T 82-84, Vespa PK AUTOMATICA 50 2T 84-89, Vespa PK XL 50 2T 85-88, Vespa PK XL PLURIMATIC 50 2T 85-90, Vespa PK XL RUSH 50 2T 88-89

RICAMBI

PT00061	Pistone completo ø 47
PT61	Pistone ø 47,4
SG15036	Serie segmenti ø 47
SG15038	Serie segmenti ø 47,4

SG15040	Serie segmenti ø 47,8
GR00727	Serie guarnizioni
TS00151	Testa



cod. **KT00049**

Gruppo termico ø 47 10 luci

Cilindro in ghisa Minacrom con 10 travasi | Cilindrata 74,60 cc - Corsa mm 43 - Rapp. Comp. 1:10,7 | Completo di testa

APPLICABILITÀ

Piaggio Vespa 50 2T 67-82, Vespa FL 50 2T 90-90, Vespa FL2 AUTOMATICA 50 2T 90-91, Vespa FL2 HP 50 2T 91-97, Vespa N 50 2T 89-90, Vespa PK 50 2T 82-84, Vespa PK AUTOMATICA 50 2T 84-89, Vespa PK XL 50 2T 85-88, Vespa PK XL PLURIMATIC 50 2T 85-90, Vespa PK XL RUSH 50 2T 88-89

RICAMBI

PT00080	Pistone completo ø 47
PT80	Pistone completo ø 47,4
PT0080	Pistone completo ø 47,8
SG15036	Serie segmenti ø 47

SG15038	Serie segmenti ø 47,4
SG15040	Serie segmenti ø 47,8
GR00727	Serie guarnizioni
TS00151	Testa



cod. **KT00058**

Gruppo termico ø 47 Peugeot SV-Geo

APPLICABILITÀ

Peugeot Buxy 50 2T -00, Buxy RS 50 2T -00, Elyseo 50 2T -00, Looxor 50 2T -00, Metal X 50 2T -00, SV Geo 50 2T -00, Speedake 50 2T -00, Speedfight 50 2T -00, Squab 50 2T -00, Trekker 50 2T -00, Vivacity 50 2T -00, X-Fight 50 2T -00, Zenith 50 2T -00

RICAMBI

PT00090	Pistone completo ø 47
PT90	Pistone completo ø 47,4
PT0090	Pistone completo ø 47,8
SG15036	Serie segmenti ø 47

SG15038	Serie segmenti ø 47,4
SG15040	Serie segmenti ø 47,8
GR00717	Serie guarnizioni



cod. **KT00087**

Gruppo termico ø 47 per motore scooter 50 cc Minarelli/Yamaha orizzontale Evolution

APPLICABILITÀ

Aprilia Gulliver 50 2T 95-98, Rally 50 2T 95-03, SR (Orizzontale) 50 2T 94-96, SR WWW 50 2T 97-01, Scarabeo 50 2T 93-05, Sonic 50 2T 98-07

Atala Carosello 50 2T -00

Benelli 491 GT 50 2T 98-99, 491 ST 50 2T 99-01, K2 50 2T 98-01, Naked 50 2T 02-02, Pepe 50 2T 99-01, Pepe LX 50 2T 03-04

Beta Ark 50 2T 96-08, Chrono 50 2T 96-00, Quadra 50 2T 95-00, Tempo 50 2T 95-00

KTM K50 50 2T -00

Macal Thunder 50 2T -00

Malaguti Centro 50 2T -00, Ciak 50 2T -00, Ciak Euro 2 2,3 50 2T 03-03, Ciak Euro 2 50 2T 01-03, Ciak Master Euro 2 50 2T 06-06, F10 50 2T -00, F10 Euro 2 50 2T -00, F10 Euro

2,3 50 2T 03-04, F10 Restyling Euro 2 50 2T 06-06, F12 Phantom 50 2T -00, F12 Phantom Euro 2,3 50 2T 03-04, F12 Restyling Euro 2 50 2T 06-06, F15 Firefox Euro 2 50 2T 05-06, Yesterday 50 2T 97-00

Mbk Eolis 50 2T 92-95, Fizz 50 2T 94-95, Flipper 50 2T -00, Flipper Euro 2 50 2T 03-03, Forte 50 2T 94-96, Mach G 50 2T 02-04, Ovetto 50 2T -00, Ovetto Euro 2 50 2T 02-02

Motron Syncro 50 2T -00, Thunder 50 2T -00

PGO Big Max 50 2T -00

Rieju First 50 2T -00, Windy 50 2T -00

Yamaha Axis 50 2T 95-96, Breeze 50 2T 94-95, Jog 50 2T -00, Jog ER 50 2T -00, Jog R 50 2T 02-10, Jog Z 50 2T 95-95, Neo's 50 2T -00, Neo's Euro 2 50 2T 02-02, Why 50 2T -00, Why Euro 2 50 2T 03-03, Zest 50 2T -00

RICAMBI

PT00102	Pistone completo ø 47
PT102	Pistone completo ø 47,4
SG15284	Serie segmenti ø 47
SG15691	Serie segmenti ø 47,4

GR00702	Serie guarnizioni
TS00170	Testa



◀ **cod. KT00088**
Gruppo termico ø 47 per motore scooter 50 cc Minarelli/Yamaha tipo verticale

APPLICABILITÀ

Aprilia Amico 50 2T 94-94, Amico 50 2T 96-98, Amico GL/GLE 50 2T 93-95, Amico LX/Sport/Cat 50 2T 92-93, SR (Verticale) 50 2T 93-93

Mbk Booster 50 2T -00, Booster Euro 2 50 2T 04-04, Booster NG 50 2T 03-00, Booster Rocket 50 2T 97-98, Booster Spirit 50 2T 03-00, Booster Track 50 2T 96-98, Stunt 50 2T 00-02

Yamaha BWS 50 2T -00, BWS Bump 50 2T 97-98, BWS Euro 2 50 2T 03-03, BWS NG 50 2T -00, BWS NG Euro 2 50 2T 03-03, Slider 50 2T 00-02, Spy 50 2T 95-98, Zuma 50 2T 97-01

RICAMBI

PT00102	Pistone completo ø 47
PT102	Pistone completo ø 47,4
SG15284	Serie segmenti ø 47

SG15691	Serie segmenti ø 47,4
GR00701	Serie guarnizioni
TS00165	Testa



◀ **cod. KT00090**
Gruppo termico ø 47 per Honda Bali

APPLICABILITÀ

Honda Bali 50 2T 93-99, SFX / SXR 50 2T 95-01, SGX SKY 50 2T 97-01, SH New 50 2T 96-01, X8R S 50 2T 98-01, X8R X 50 2T 98-01

RICAMBI

PT00103	Pistone completo ø 47
PT103	Pistone completo ø 47,4
SG15695	Serie segmenti ø 47

SG15696	Serie segmenti ø 47,4
GR00709	Serie guarnizioni



◀ **cod. KT00109**
Gruppo termico ø 47 per motore scooter 50 cc Minarelli/Yamaha Liquid Cooled

APPLICABILITÀ

Aprilia Area 51 50 2T 98-00, Gulliver LC 50 2T 96-98, Rally Liquid Cooled 50 2T 96-99, SR Liquid Cooled 50 2T 94-96, SR Reding 50 2T 97-99, SR Stealth 50 2T 97-99, Sonic GP 50 2T 98-08

Benelli 491 RR 50 2T 99-01, 491 Racing 50 2T 98-99, 491 SP 50 2T 99-99, 491 Sport 50 2T 98-99, K2 Liquid Cooled 50 2T 98-01

Beta Ark LC 50 2T 96-08, Eikon 50 2T 99-03

Italjet Dragster 50 2T -00

Malaguti F12 Phantom LC 50 2T -00, F12 R Phantom LC 50 2T 07-07, F15 Firefox 50 2T -00, F15 Firefox Euro 2 50 2T 02-06, F15 Firefox Euro 2,3 50 2T 03-04

Mbk Mach G LC 50 2T 02-04, Nitro 50 2T -00, Nitro Euro 2 50 2T 03-03

Yamaha Aerox 50 2T -00, Aerox Euro 2 50 2T 03-03, Jog R LC 50 2T -00

RICAMBI

PT00102	Pistone ø 47
PT102	Pistone ø 47,4
SG15284	Serie segmenti ø 47
SG15691	Serie segmenti ø 47,4

GR00711	Rid. ermetica con guarnizione
GR00713	Serie guarnizioni
TS00175	Testa ø 47



◀ **cod. KT00116**
Gruppo termico ø 47 Peugeot Liquid Cooled con testa

APPLICABILITÀ

Peugeot Speedfight 50 2T -00, X-Fight 50 2T -00

RICAMBI

PT00090	Pistone ø 47
PT90	Pistone ø 47,4
PT0090	Pistone ø 47,8
SG15036	Serie segmenti ø 47
SG15038	Serie segmenti ø 47,4

SG15040	Serie segmenti ø 47,8
GR00714	Serie guarnizioni
GR00721	Serie guarnizioni
TS00184	Testa

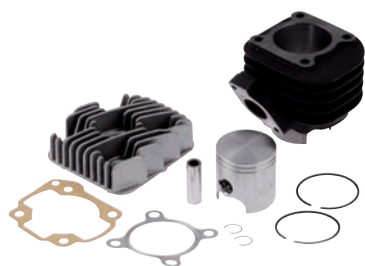

cod. **KT00128**
Gruppo termico ø 47 Keeway Focus

APPLICABILITÀ

Benelli Pepe 50 2T 10-10, Pepe LX 50 2T 07-09, Pepe Old 50 2T 07-09, Pepe Old 50 2T 11-11, Quattronex 50 2T 08-11

CPI Aragon 50 2T 03-03, Hussar 50 2T 03-03, Oliver 50 2T 03-03, Pop Corn 50 2T 03-03

Explorer Cracker 50 2T 03-03

Keeway F-Act 50 2T 07-08, Flash 50 2T 07-08, Focus 50 2T 06-06, Goccia 50 2T 09-09, Hurricane 50 2T 06-08, Matrix 50 2T 06-08, Pixel Euro 2 50 2T -00, RY8 50 2T 08-08

Malaguti F10 Wap Euro 2 50 2T -00, F12 R Phantom 50 2T 07-07

RICAMBI

PT00106	Pistone ø 47
PT106	Pistone ø 47,4
SG15284	Serie segmenti ø 47
SG15691	Serie segmenti ø 47,4

GR00732	Serie guarnizioni
TS00170	Testa
SP00726	Spinotto



cod. **KT00086**
Gruppo termico ø 48 Sfera - Zip Evolution

APPLICABILITÀ

Aprilia Mojito 50 2T 04-08, Scarabeo 2T EU2 Motore Piaggio 50 2T 10-12, Scarabeo 2T Net 50 2T 09-10, Scarabeo Street 50 2T 05-06, Scarabeo Street 2T Restyling 50 2T 06-09, Sport City One 2T 50 2T 08-11

Derbi Atlantis 2T 50 2T 10-10, Atlantis 2T EU2 50 2T 07-09, Atlantis O2 50 2T 02-02, Atlantis O2 Bullet 50 2T 03-05, Atlantis O2 City 50 2T 03-06, Atlantis O2 Red Bullet 50 2T 03-03, Atlantis O2 Two Chic 50 2T 05-05, Boulevard 50 2T 09-12, Sonar 2T 50 2T 09-09

Gilera Easy Moving 50 2T 95-96, Ice 50 2T 01-05, Stalker 50 2T 97-11, Stalker Naked 50 2T 08-08, Stalker Special Edition 50 2T 07-08, Storm 50 2T 94-95, Storm Euro 2 50 2T 07-07, Typhoon 50 2T 94-97, Typhoon X 50 2T 98-99, Typhoon XR 50 2T 00-00

Italjet Jet Set 50 2T -00, Torpedo New 50 2T -00

Piaggio Diesis 50 2T 01-01, Fly 2T 50 2T 05-07, Fly 2T 50 2T 10-11, Free 50 2T 92-94, Free Delivery 50 2T 00-01, Free FL 50 2T 95-02, Liberty 50 2T 97-05, Liberty 2T 50 2T 06-08, Liberty 2T PTT EU2 50 2T 04-05, Liberty 2T RST 50 2T 04-04, Liberty 2T Sport 50 2T 06-08, Liberty MOC 2T & Elle 50 2T 09-12, NRG Power DT 50 2T 06-11, NRG Power DT Serie Speciale 50 2T 07-08, Sfera 50 2T 91-93, Sfera Maquillage 2 50 2T 94-94, Sfera RST 50 2T 95-97, Typhoon 50 2T 01-09, Typhoon 2T E2 50 2T 10-12, Typhoon 2T E3 CH 50 2T 11-11, Vespa ET2 50 2T 97-05, Vespa ET2 iniezione 50 2T 97-00, Vespa LX 2T 50 2T 05-08, Vespa LX 2T FL 50 2T 09-10, Vespa LX 2T Touring 50 2T 10-11, Vespa LXV 2T 50 2T 06-08, Vespa LXV 2T NAVY 50 2T 08-08, Vespa S 2T & College 50 2T 07-12, Zip 50 2T 92-93, Zip 50 2T 95-96, Zip Bimodale 50 2T 94-97, Zip Fast Rider 50 2T 93-94, Zip Fast Rider RST 50 2T 96-97, Zip RST 50 2T 96-99

RICAMBI

PT00100	Pistone completo ø 48
PT100	Pistone completo ø 48,5
PT0100	Pistone completo ø 49
SG15688	Serie segmenti ø 48

SG15689	Serie segmenti ø 48,5
GR06411	Serie guarnizioni
TS00166	Testa



cod. **KT00091**
Gruppo termico ø 48 Piaggio Liquid Cooled Evolution

APPLICABILITÀ

Aprilia SR (motore Piaggio) '03 - '05, SR R Factory '04 - '07

Gilera Runner, Runner SP

Piaggio NRG mc2, NTT, Zip SP

RICAMBI

PT00100	Pistone ø 48
PT100	Pistone ø 48,5
PT0100	Pistone ø 49
SG15688	Serie segmenti ø 48

SG15689	Serie segmenti ø 48,5
SG15690	Serie segmenti ø 49
GR00708	Serie guarnizioni
TS00178	Testa



◀ **cod. KT00097**
Gruppo termico ø 48 per Piaggio Liquid Cooled con raccordo

APPLICABILITÀ

Aprilia SR R 50 2T 04-09, SR R FACTORY 50 2T 04-09, SR R FACTORY Carburatore 50 2T 10-12, SR Street 50 2T 03-12
Derbi GP1 50 2T 01-03, GP1 EU2 50 2T 05-05, GP1 Open EU2 50 2T 06-09, GP1 Race EU2 50 2T 05-07
Gilera DNA 50 2T 00-02, DNA 50 2T 05-07, DNA GP Experience 50 2T 03-04, Runner 50 2T 97-00, Runner Poggiali 50 2T 02-02, Runner SP 50 2T 02-07, Runner SP 50 2T 10-12, Runner SP ST & Simoncelli 50 2T 08-09, Runner SP Special Edition 50 2T 07-07

Piaggio NRG 50 2T 94-96, NRG Extreme 50 2T 99-00, NRG MC3 50 2T 01-04, NRG Power DD 50 2T 05-11, NRG Power DD Serie Speciale 50 2T 07-11, NRG Power Pure Jet 50 2T-IE 04-05, NRG Power PureJet 50 2T-IE 06-11, NRG PureJet 50 2T-IE 02-04, NRG PureJet 50 2T-IE 10-10, NRG RST MC2 50 2T 96-98, NRG 50 2T 95-96, Quartz 50 2T 92-96, Zip 2T 50 2T 08-12, Zip LC 50 2T 00-04, Zip Sp 50 2T 96-04, Zip Sp Euro 2.50 2T 06-12

RICAMBI

PT00100	Pistone ø 48
PT100	Pistone ø 48,5
PT0100	Pistone ø 49
SG15688	Serie segmenti ø 48

SG15689	Serie segmenti ø 48,5
GR00708	Serie guarnizioni
TS00178	Testa
AA00769	Raccordo per testa



◀ **cod. KT00114**
Gruppo termico ø 49 per motore Minarelli AM con testa

APPLICABILITÀ

Aprilia Classic 50 2T 92-99, Europa 50 2T 91-92, MX 50 50 2T 04-04, MX 50 Motard 50 2T 95-03, Pegaso 50 2T 92-94, RS 50 50 2T 91-05, RX 50 50 2T 03-04, RX 50 3-5 Marce 50 2T 91-94, RX 50 Enduro 50 2T 95-03, RX 50 Racing 50 2T 03-06, Tuono 50 50 2T 03-04
Beta RR Alu 50 2T -00, RR Enduro 50 50 2T -00, RR Motard 50 50 2T -00
CH Husqvarna SM 50 50 2T -00, WR 50 50 2T -00, WSM 50 50 2T -00
CMC Enduro 50 50 2T 11-11, Motard 50 50 2T 11-11
Fantic Caballero Motard 50 50 2T 06-10, Caballero Regolarità 50 2T 06-10
HM Baja, Derapage Basic 50 50 2T 10-11, CMC 50 50 2T 10-11, CRE Baja RR, Derapage RR 50 50 2T 07-11, CRE Baja, Derapage 50 50 2T 07-11, CRE Six Competition 50 50 2T 10-11, CRE Six, Baia, Derapage 50 50 2T 95-06, CRE Six, Derapage Competition 50 50 2T 07-09, Derapage Competition 50 50 2T 10-11
MBK X Limit 50 50 2T -00, X Power 50 50 2T -00

Malaguti CNK Drakon 50 50 2T 05-07, Fifty Evolution 50 50 2T 90-93, XSM 50 50 2T -00, XTM 50 50 2T -00
Minarelli AM 345 Motori Minarelli 50 50 2T -00
Motorhispania Furia 50 50 2T -00, Furia Max 50 50 2T -00, RX 50 50 2T -00, RX 50 R 50 2T -00
Peugeot Supermotard 50 50 2T -00, XP6 Trail S/Avv. Elettrico 50 50 2T -00, XR6 Racing Cat. C/avv.elett. 50 50 2T -00
Rieju MRT 50 50 2T -00, MRT 50 PRO 50 50 2T -00, MRT 50 PRO SM 50 50 2T -00, MRT 50 SM 50 50 2T -00, MRX 50 50 2T -00, MRX 50 PRO 50 50 2T -00, RR 50 50 2T -00, RS1 50 50 2T -00, RS2 50 Matrix 50 50 2T -00, RS2 50 Matrix Pro 50 50 2T -00, RS2 Naked 50 50 2T -00, SMX 50 E.S./K.S. 50 50 2T -00, SMX 50 PRO E.S./K.S. 50 50 2T -00, Spike 50 50 2T -00
Sherco HRD Enduro 50 50 2T -00, HRD Motard 50 50 2T -00
Yamaha DT R 50 50 2T 03-10, DT RSM 50 50 2T 03-05, DT X 50 50 2T 06-10, TZR 50 50 2T 03-08, TZR 50 50 2T 10-11, TZR RR 50 50 2T 05-05

RICAMBI

PT00150	Pistone completo ø 49
PT150	Pistone completo ø 49,5
SG15679	Serie segmenti ø 49

SG15698	Serie segmenti ø 49,5
GR00712	Serie guarnizioni
TS00174	Testa



◀ **cod. KT00133**
Gruppo termico ø 49 Piaggio 4T

APPLICABILITÀ

Aprilia Scarabeo 4T 50 4T 02-06, Scarabeo 4T Restyling EU3 50 4T 06-09, Sport City One 4T 50 4T 08-10
Derbi Atlantis 4T 50 4T 04-06, Atlantis 4T EU2 50 4T 07-07, Boulevard 4T EU2 50 4T 09-09
Italjet Torpedo 50 4T -00
Malaguti Centro Euro 2.50 4T 08-08, Centro SL 4T 50 4T 10-10, Ciak Master 4T 50 4T 05-06, Ciak Master Euro 2.50 4T 05-06

Piaggio Fly 4T 50 4T 05-11, Fly 4T Motore CHN 50 4T 06-07, Liberty 4T 50 4T 00-02, Liberty 4T 50 4T 05-08, Liberty 4T Delivery 50 4T 10-11, Liberty 4T Delivery TNT 50 4T 09-09, Liberty 4T PTT 50 4T 09-11, Liberty 4T RST 50 4T 04-04, Liberty 4T Sport 50 4T 06-08, Liberty MOC 4T & Elle 50 4T 09-11, Vespa ET4 50 4T 00-05, Vespa LX 4T 50 4T 05-08, Zip 4T 50 4T 00-12

RICAMBI

PT00159	Pistone ø 49
PT159	Pistone ø 49,5
SG15715	Serie segmenti ø 49

SG15716	Serie segmenti ø 49,5
GR00737	Serie guarnizioni



◀ **cod. KT00012**
Gruppo termico Vespa ø 50 3 travasi

APPLICABILITÀ

Piaggio Ape 50 P 50 2T 80-85, Ape 50 TM P 50 2T 85-89, Ape EU2 50 2T 03-10, Ape FL - FL2 50 2T 89-95, Ape FL3 50 2T 96-99, Ape RST MIX 50 2T 99-03, Vespa 50 2T 67-82, Vespa FL 50 2T 90-90, Vespa FL2 AUTOMATICA 50 2T 90-91, Vespa FL2 HP 50 2T 91-97, Vespa N 50 2T 89-90, Vespa PK 50 2T 82-84, Vespa PK AUTOMATICA 50 2T 84-89, Vespa PK XL 50 2T 85-88, Vespa PK XL PLURIMATIC 50 2T 85-90, Vespa PK XL RUSH 50 2T 88-89

RICAMBI

PT00060	Pistone ø 50
PT60	Pistone ø 50,4
SG15173	Serie segmenti ø 50
SG15175	Serie segmenti ø 50,4

SG15177	Serie segmenti ø 50,8
GR00727	Serie guarnizioni
TS00151	Testa



◀ **cod. KT00132**
Gruppo termico ø 50 Kymco 4T

APPLICABILITÀ

Baotian Eco Bike 50 4T -00, Rebel 50 4T -00, Rochy 50 4T -00, Tanco 50 4T -00
Garelli Capri LX 50 4T 06-08, Giclone 50 4T 06-08, Flexi 50 4T 08-11, New Vip 50 4T 06-07, Tiesse 4T 50 4T 08-10, Vip 50 4T 06-06
Hupper Montecarlo 30 50 4T -00
Kymco Agility 4T Carry 50 4T 11-11, Agility 4T R10 50 4T 06-08, Agility 4T R12 50 4T 07-08, Agility R12 50 4T 05-05, Agility R16 50 4T 08-09, Agility R16 50 4T 12-12, Agility RS 50 4T 09-09, Dink Euro 2 50 4T 07-07, Filly 50 4T 98-00, Filly LX 50 4T 01-02, Like 50 4T 09-09, Like 50 2T 09-09, People 5 4T 50 4T 06-08, Sento 50 4T 08-08, Super 8 50 4T 07-07, Super 8 50 2T 09-09, Super 8 4T 50 4T 09-09, Vitality 4T 50 4T 04-04

Malaguti DVD 50 4T 10-10
Peugeot V-Clic 50 4T -00
Rieju Pacific 50 4T -00, Paseo 50 4T -00, Toreo 50 4T -00
Sym Symply Euro 2 50 4T 07-08
WT Motors Bilbao 50 4T -00

RICAMBI

PT00158	Pistone ø 50
PT158	Pistone ø 50,5
SG15713	Serie segmenti ø 50

SG15714	Serie segmenti ø 50,5
GR00736	Serie guarnizioni



◀ **cod. KT00014**
Gruppo termico Vespa ø 55 6 travasi

APPLICABILITÀ

Piaggio Ape 50 P 50 2T 80-85, Ape 50 TM P 50 2T 85-89, Ape EU2 50 2T 03-10, Ape FL - FL2 50 2T 89-95, Ape FL3 50 2T 96-99, Ape RST MIX 50 2T 99-03, Vespa 50 2T 67-82, Vespa FL 50 2T 90-90, Vespa FL2 AUTOMATICA 50 2T 90-91, Vespa FL2 HP 50 2T 91-97, Vespa N 50 2T 89-90, Vespa PK 50 2T 82-84, Vespa PK AUTOMATICA 50 2T 84-89, Vespa PK XL 50 2T 85-88, Vespa PK XL PLURIMATIC 50 2T 85-90, Vespa PK XL RUSH 50 2T 88-89

RICAMBI

PT00062	Pistone ø 55
PT62	Pistone ø 55,4
SG15178	Serie Segmenti ø 55
SG15180	Serie Segmenti ø 55,4

SG15182	Serie Segmenti ø 55,8
GR00727	Serie guarnizioni
TS00153	Testa



◀ **cod. KT00015**
Gruppo termico Vespa ø 57 ET3 con testa

APPLICABILITÀ

Piaggio Vespa 125 ET3 125 2T 76-83, Vespa 125 Primavera 125 2T 67-83

RICAMBI

PT00063	Pistone completo ø 57
PT63	Pistone completo ø 57,4
SG15186	Serie segmenti ø 57

SG15187	Serie segmenti ø 57,4
GR00728	Serie guarnizioni
TS00158	Testa



◀ cod. **KT00018**
Gruppo termico ø 60 PX 80

APPLICABILITÀ

Piaggio Vespa PX 80 E (DEU) 80 2T 81-97

RICAMBI

PT00065	Pistone completo ø 60
PT65	Pistone completo ø 60,4
SG15582	Serie segmenti ø 60
SG15583	Serie segmenti ø 60,4

GR00729	Serie guarnizioni
TS00157	Testa
AA06507	Boccole distanziali



◀ cod. **KT00017**
Gruppo termico Vespa ø 63 PX

APPLICABILITÀ

LML Star Deluxe EU1 125 125 2T 01-03, Star Deluxe EU3 125 125 2T 08-09, Star Deluxe EU1 150 150 2T 01-03, Star Deluxe EU3 150 150 2T 08-09

Piaggio Vespa PX 125 125 2T 98-01, Vespa PX 125 125 2T 11-11, Vespa PX 125 EU2 125 2T 01-07, Vespa PX 30 Anni 125 2T 07-08, Vespa PX E 125 Arcobaleno 125 2T 81-97, Vespa PX 150 150 2T 98-01, Vespa PX E 150 Arcobaleno 150 2T 81-97

RICAMBI

PT00064	Pistone completo ø 63
PT64	Pistone completo ø 63,4
SG15194	Serie segmenti ø 63

SG15196	Serie segmenti ø 63,4
GR00729	Serie guarnizioni
TS00156	Testa



◀ cod. **KT00019**
Gruppo termico ø 69 per Piaggio Ape P 601 Car spinotto 18

APPLICABILITÀ

Piaggio Ape Car P2 (1ª serie) 220 2T -00, Ape P 501 220 2T 78-85, Ape P 601 220 2T -00, Ape P 601V 220 2T -00

RICAMBI

PT00067	Pistone ø 69 spinotto 18
PT67	Pistone ø 69,4 spinotto 18
SG15146	Serie segmenti ø 69

SG15147	Serie segmenti ø 69,4
SG15149	Serie segmenti ø 69,8
GR00730	Serie guarnizioni

◀ cod. **KT00020**
Gruppo termico ø 69 per Piaggio Ape MP MPV spinotto 16

APPLICABILITÀ

Piaggio Ape MP 220 2T -00, Ape MPM 600 220 2T -00, Ape MPR 500 220 2T -00, Ape MPV 600 220 2T -00

RICAMBI

PT00066	Pistone ø 69 spinotto 16
PT66	Pistone ø 69,4 spinotto 16
PT00066	Pistone ø 69,8 spinotto 16
SG15146	Serie segmenti ø 69

SG15147	Serie segmenti ø 69,4
SG15149	Serie segmenti ø 69,8
GR00730	Serie guarnizioni

VALVOLE LAMELLARI



- ◀ cod. **XX01013**
Valvola lamellare conica completa per Moby 51

SERIE SEGMENTI



- ◀ cod. **SG15699**
2 segmenti AC 2 x mm 1,5 semitrapezoidali (1 in cromo)
ø 40 Minarelli/Yamaha
- ◀ cod. **SG15701**
2 segmenti AC 2 x mm 1,5 semitrapezoidali (1 in cromo)
ø 40,5 Minarelli/Yamaha
- ◀ cod. **SG15702**
2 segmenti AC 2 x mm 1,5 semitrapezoidali (1 in cromo)
ø 41 Minarelli/Yamaha
- ◀ cod. **SG15703**
2 segmenti AC 4 x mm 1,2 semitrapezoidali (1 in cromo)
ø 40 Minarelli/Yamaha
- ◀ cod. **SG15704**
2 segmenti AC 4 x mm 1,2 semitrapezoidali (1 in cromo)
ø 40,5 Minarelli/Yamaha
- ◀ cod. **SG15705**
2 segmenti AC 4 x mm 1,2 semitrapezoidali (1 in cromo)
ø 41 Minarelli/Yamaha
- ◀ cod. **SG15682**
2 segmenti AC 4 x mm 1,2 (grano interno) ø 40
- ◀ cod. **SG15683**
2 segmenti AC 4 x mm 1,2 (grano interno) ø 40,5
- ◀ cod. **SG15684**
2 segmenti AC 4 x mm 1,2 (grano interno) ø 41

A series of horizontal dotted lines for writing notes, spanning the width of the page.

NOTE

A series of horizontal dotted lines for writing notes, starting from the top of the page and extending downwards.



L'azienda in numeri

La Motorparts si trova a Lippo di Calderara di Reno in provincia di Bologna, a pochissima distanza dall'aeroporto internazionale Marconi e dall'autostrada.

La sede è stata recentemente rinnovata: 15.000 mq su cui si sviluppano gli uffici, il reparto R&D, il magazzino. Una struttura efficiente e all'avanguardia che consente una distribuzione capillare, rapida e precisa.

Motorparts distribuisce i suoi prodotti in Italia e all'estero in oltre 40 nazioni, attraverso una consolidata rete di agenti e distributori, a oltre 1.000 clienti attivi.

Vittorie e record

Il 6 ottobre 1996, sulla pista per alte velocità di Nardò (LE), uno scooter realizzato e motorizzato dalla Motori Minarelli e preparato dalla Top Performances, ha stabilito 2 nuovi primati mondiali di velocità per la classe 80cc :

- 1 miglio con partenza da fermo percorso in 42"754
alla media di 135,511 km/h;
- 1 miglio con partenza lanciata percorso in 36"352
alla media di 159,382 km/h

Pilota Davide Govoni, tecnico del reparto esperienze della Top Performances. Mezzo: Lolu Dragster, con telaio in lega di alluminio, e motore scooter equipaggiato con parti speciali Top Performances.

Dal 1966 la Motori Minarelli ha scritto più volte il proprio nome nell'albo d'oro dei record mondiali; i record stabiliti sono 18: 1966, 1967, 1969, 1971, 1973, 1975.



motorparts.it



Motorparts S.p.A.
Via Aldina, 26
40012 Lippo di Calderara di Reno (BO)
Tel. +39 051 725442 - fax +39 051 725449